

Young

SOP03312 - ø 30 cm. - 30 W - 2230 lm / 4000 K / CRI > 80

DESCRIPTION

Young is made of matt white painted aluminium and is characterized by the reduced thickness of the body which makes it pleasant even when installed in rooms with very low ceilings; it is equipped with an opal diffusing screen in PMMA and, thanks to the SMD LED sources integrated in the body of the luminaire, it lights up perfectly evenly; Young allows to obtain soft and diffused down light effects perfectly distributed and free of hard shadows. Young is complete with drivers integrated into the body of the device.



Switch

On+Off

PRODUCTS CHARACTERISTICS

installation type	Ceiling / Wall diffusers
material	Aluminum
Color	White
Power	30 W
Lumen output - Full emission	2400 lm
net weight	1,6 kg.

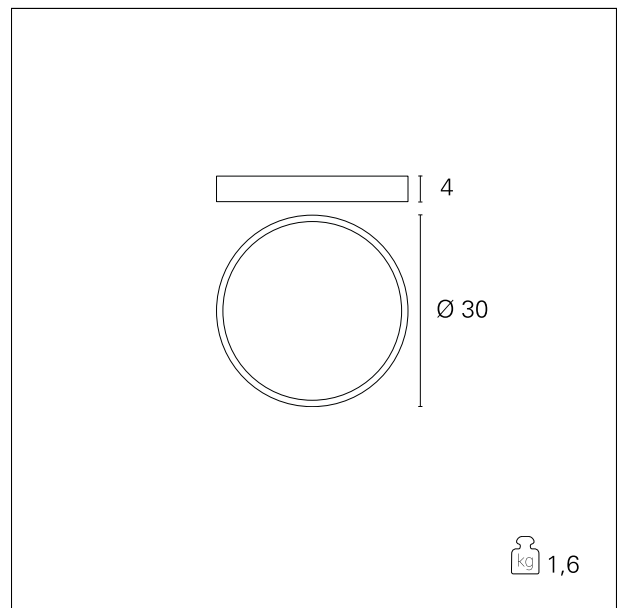

ELECTRICAL CHARACTERISTICS

feeding	220÷240 V
driver	On+Off
Insulation class	Class II

MECHANICAL CHARACTERISTICS

product IP rate	IP20
-----------------	-------------

Young

SOP03312 - ø 30 cm. - 30 W - 2230 lm / 4000 K / CRI > 80

LED SOURCE DETAILS

led source type	SMD Led
Light source connection	LED
Light temperature	4000 K
CRI	CRI > 80

DRIVER CHARACTERISTICS

driver	On / Off
--------	-----------------

LIGHTING DETAILS

luminous effect	diffused light
optic	110°

PHOTOMETRIC

