

Nemo TL Comfort

RTT22413DA - Trimless + Matt Bronze Reflector - 15 W - 1450 lumen / 3000 K / CRI >90

DESCRIPTION

Nemo TL is the trimless series of the Nemo family designed for installations in plasterboard false ceilings with no visible edge. Models up to 24W are equipped with a pre-drilled fixed frame for direct fixing of the luminaire to the false ceiling; The 33W and 42W models are equipped with height-adjustable fixing frame. Nemo TL Comfort is the solution for installations with maximum visual comfort; thanks to its 48 ° cut off, the TL Comfort version of the Nemo series guarantees maximum control of direct glare. The lighting modules are all equipped with the latest generation of LEDs (CRI > 90 and SDCM < 3). The interchangeable secondary reflectors are available in four different satin finishes and allow you to aesthetically characterize the system even after the first installation without changing the lighting performance. The safety cable supplied prevents accidental drops and the "fast plug" connection system to the driver allows quick and safe installation.



Switch

DALI

PRODUCTS CHARACTERISTICS

installation type	trimless recessed
material	Aluminum
Color	Matt bronze
Power	15 W
Lumen output - Full emission	1402 lm
Efficacy	93 lm/W
Diameter	Ø 71 mm.
Dimensions	h 130 mm.
net weight	0,33 kg.

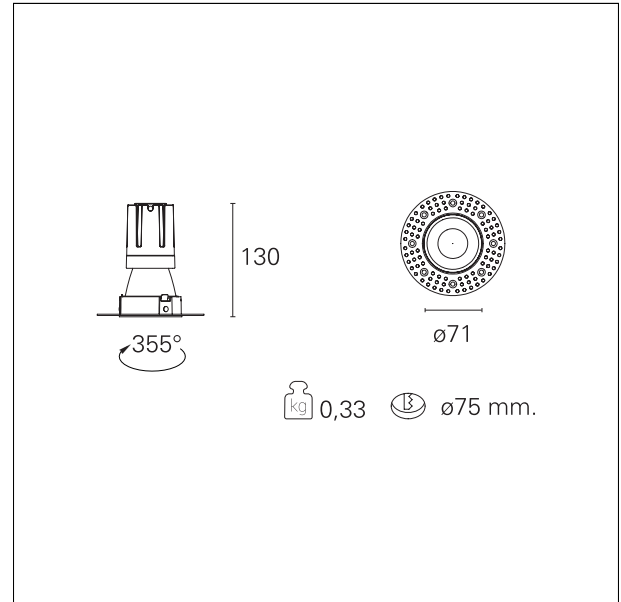

ELECTRICAL CHARACTERISTICS

feeding	220÷240 V
driver	DALI
Insulation class	Class II

Nemo TL Comfort

RTT22413DA - Trimless + Matt Bronze Reflector - 15 W - 1450 lumen / 3000 K / CRI >90

MECHANICAL CHARACTERISTICS

optical compartment IP rate	IP40
recessed compartment IP rate	IP20
IK	IK02

HOLE RECESS DIMENSIONS

hole recess diameter	Ø 75 mm.
----------------------	-----------------

ENERGY CLASSIFICATION



This luminaire contains built-in LED lamps.



The lamps cannot be changed in the luminaire.

LED SOURCE DETAILS

led source type	CoB Led
LED brand	Bridgelux
LED current	350 mA
LED voltage	36 V
Service lifetime	L80 / B20 - 50.000 h.
Light temperature	3000 K
CRI	CRI >90
SDCM	< 3

DRIVER CHARACTERISTICS

driver	DALI
Power factor	> 0,9
Operating temperature	-20°C ÷ 45°C

LIGHTING DETAILS

emission	rotationally symmetrical
----------	---------------------------------

Nemo TL Comfort

RTT22413DA - Trimless + Matt Bronze Reflector - 15 W - 1450 lumen / 3000 K / CRI >90

luminous effect	flood
optic	38°
Beam angle - direct	38°
UGR	≤ 17
Cut Hood	48°

PHOTOMETRIC

