

### Nemo TL Comfort

**RTT22246DA** - Trimless + Matt White Reflector - 15 W - 1450 lumen / 2700 K / CRI >90

#### DESCRIPTION

Nemo TL is the trimless series of the Nemo family designed for installations in plasterboard false ceilings with no visible edge. Models up to 24W are equipped with a pre-drilled fixed frame for direct fixing of the luminaire to the false ceiling; The 33W and 42W models are equipped with height-adjustable fixing frame. Nemo TL Comfort is the solution for installations with maximum visual comfort; thanks to its 48 ° cut off, the TL Comfort version of the Nemo series guarantees maximum control of direct glare. The lighting modules are all equipped with the latest generation of LEDs (CRI > 90 and SDCM < 3). The interchangeable secondary reflectors are available in four different satin finishes and allow you to aesthetically characterize the system even after the first installation without changing the lighting performance. The safety cable supplied prevents accidental drops and the "fast plug" connection system to the driver allows quick and safe installation.



Switch

**DALI**

#### PRODUCTS CHARACTERISTICS

installation type	<b>trimless recessed</b>
material	<b>Aluminum</b>
Color	<b>Matt white</b>
Power	<b>15 W</b>
Lumen output - Full emission	<b>1349 lm</b>
Efficacy	<b>90 lm/W</b>
Diameter	<b>Ø 71 mm.</b>
Dimensions	<b>h 130 mm.</b>
net weight	<b>0,33 kg.</b>

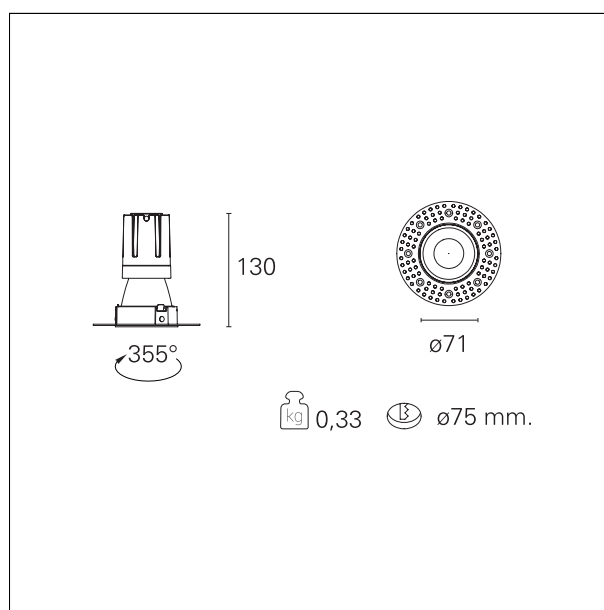

#### ELECTRICAL CHARACTERISTICS

feeding	<b>220÷240 V</b>
driver	<b>DALI</b>
Insulation class	<b>Class II</b>

### Nemo TL Comfort

**RTT22246DA** - Trimless + Matt White Reflector - 15 W - 1450 lumen / 2700 K / CRI >90

#### MECHANICAL CHARACTERISTICS

optical compartment IP rate	<b>IP40</b>
recessed compartment IP rate	<b>IP20</b>
IK	<b>IK02</b>

#### HOLE RECESS DIMENSIONS

hole recess diameter	<b>Ø 75 mm.</b>
----------------------	-----------------

#### ENERGY CLASSIFICATION



This luminaire contains built-in LED lamps.



The lamps cannot be changed in the luminaire.

#### LED SOURCE DETAILS

led source type	<b>CoB Led</b>
LED brand	<b>Bridgelux</b>
LED current	<b>350 mA</b>
LED voltage	<b>36 V</b>
Service lifetime	<b>L80 / B20 - 50.000 h.</b>
Light temperature	<b>2700 K</b>
CRI	<b>CRI &gt;90</b>
SDCM	<b>&lt; 3</b>

#### DRIVER CHARACTERISTICS

driver	<b>DALI</b>
Power factor	<b>&gt; 0,9</b>
Operating temperature	<b>-20°C ÷ 45°C</b>

#### LIGHTING DETAILS

emission	<b>rotationally symmetrical</b>
----------	---------------------------------

### Nemo TL Comfort

**RTT22246DA** - Trimless + Matt White Reflector - 15 W - 1450 lumen / 2700 K / CRI >90

luminous effect optic	<b>flood</b>
Beam angle - direct	<b>24°</b>
UGR	<b>≤ 17</b>
Cut Hood	<b>48°</b>

### PHOTOMETRIC

