

Nemo TL Comfort

RTT2132DA - Trimless + Matt Silver Reflector - 33 W - 3100 lumen / 4000 K / CRI >90

DESCRIPTION

Nemo TL is the trimless series of the Nemo family designed for installations in plasterboard false ceilings with no visible edge. Models up to 24W are equipped with a pre-drilled fixed frame for direct fixing of the luminaire to the false ceiling; The 33W and 42W models are equipped with height-adjustable fixing frame. Nemo TL Comfort is the solution for installations with maximum visual comfort; thanks to its 48 ° cut off, the TL Comfort version of the Nemo series guarantees maximum control of direct glare. The lighting modules are all equipped with the latest generation of LEDs (CRI > 90 and SDCM < 3). The interchangeable secondary reflectors are available in four different satin finishes and allow you to aesthetically characterize the system even after the first installation without changing the lighting performance. The safety cable supplied prevents accidental drops and the "fast plug" connection system to the driver allows quick and safe installation.



Switch

DALI

PRODUCTS CHARACTERISTICS

| | |
|------------------------------|--------------------------|
| installation type | trimless recessed |
| material | Aluminum |
| Color | Satin |
| Power | 33 W |
| Lumen output - Full emission | 3098 lm |
| Efficacy | 94 lm/W |
| Diameter | Ø 121 mm. |
| Dimensions | h 200 mm. |
| net weight | 0,99 kg. |

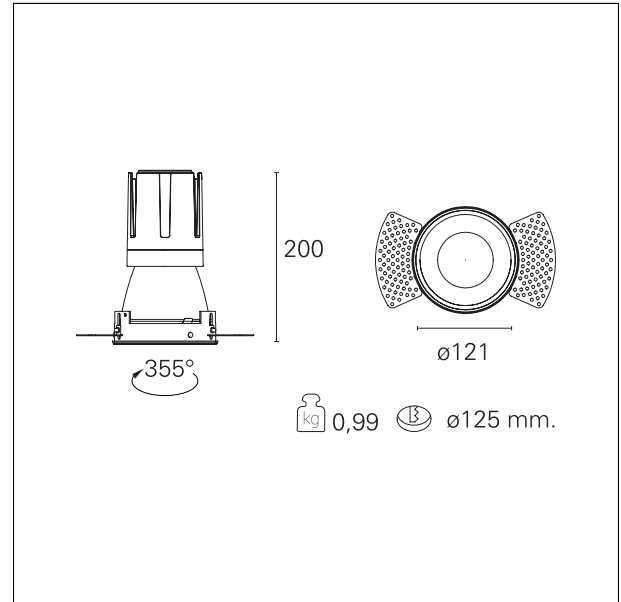

ELECTRICAL CHARACTERISTICS

| | |
|------------------|------------------|
| feeding | 220÷240 V |
| driver | DALI |
| Insulation class | Class II |

Nemo TL Comfort

RTT22132DA - Trimless + Matt Silver Reflector - 33 W - 3100 lumen / 4000 K / CRI >90

MECHANICAL CHARACTERISTICS

| | |
|------------------------------|-------------|
| optical compartment IP rate | IP40 |
| recessed compartment IP rate | IP20 |
| IK | IK02 |

HOLE RECESS DIMENSIONS

| | |
|----------------------|------------------|
| hole recess diameter | Ø 125 mm. |
|----------------------|------------------|

ENERGY CLASSIFICATION



This luminaire contains built-in LED lamps.



The lamps cannot be changed in the luminaire.

LED SOURCE DETAILS

| | |
|-------------------|------------------------------|
| led source type | CoB Led |
| LED brand | Bridgelux |
| LED current | 800 mA |
| LED voltage | 36 V |
| Service lifetime | L80 / B20 - 50.000 h. |
| Light temperature | 4000 K |
| CRI | CRI >90 |
| SDCM | < 3 |

DRIVER CHARACTERISTICS

| | |
|-----------------------|---------------------|
| driver | DALI |
| Power factor | > 0,9 |
| Operating temperature | -20°C ÷ 45°C |

LIGHTING DETAILS

| | |
|----------|---------------------------------|
| emission | rotationally symmetrical |
|----------|---------------------------------|

Nemo TL Comfort

RTT22132DA - Trimless + Matt Silver Reflector - 33 W - 3100 lumen / 4000 K / CRI >90

| | |
|-----------------------|-------------|
| luminous effect optic | wide |
| Beam angle - direct | 55° |
| UGR | ≤ 21 |
| Cut Hood | 48° |

PHOTOMETRIC

