

### Nemo TL Fix

**RTT21436** - Trimless + Gold Reflector - 42 W - 3800 lumen / 4000 K / CRI >90

#### DESCRIPTION

Nemo TL is the trimless series of the Nemo family designed for installations in plasterboard false ceilings with no visible edge. Models up to 24W are equipped with a pre-drilled fixed frame for direct fixing of the luminaire to the false ceiling; The 33W and 42W models are equipped with height-adjustable fixing frame. Four beam openings with 38 ° cut-off and versions up to UGR <17 allow to obtain the right balance between luminance control and light diffusion. The lighting modules are all equipped with latest generation LEDs with CRI > 90 and SDCM <3. The range of Nemo TL Adj and Nemo TL Fix has interchangeable secondary reflectors available in five different aesthetic finishes that allow the system to be characterized even after the first installation. The safety cable supplied prevents accidental drops and the "fast plug" connection system to the driver allows quick and safe installation. Nemo ADJ version for accent lighting with 350 ° adjustability on the horizontal plane and 30 ° on the vertical plane. Nemo Fix is perfect for vertical lighting for the control of direct glare and soft light at the edges of the beam.



Switch

On:Off

#### PRODUCTS CHARACTERISTICS

installation type  
material  
Color  
Power  
Lumen output - Full emission  
Efficacy  
Diameter  
Dimensions  
net weight

**trimless recessed**  
**Aluminum**  
**Gold**  
**42 W**  
**3858 lm**  
**92 lm/W**  
**Ø 142 mm.**  
**h 184 mm.**  
**1,49 kg.**

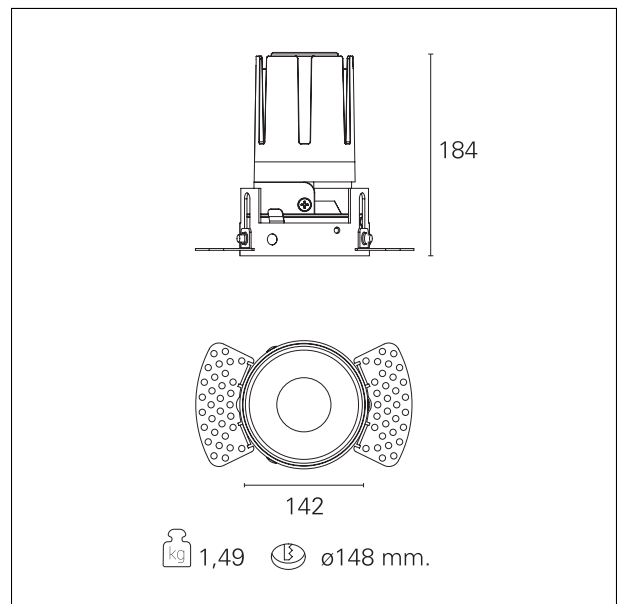

#### ELECTRICAL CHARACTERISTICS

feeding  
driver

**220÷240 V**  
**On:Off**

### Nemo TL Fix

**RTT21436** - Trimless + Gold Reflector - 42 W - 3800 lumen / 4000 K / CRI >90

Insulation class **Class II**

#### MECHANICAL CHARACTERISTICS

optical compartment IP rate **IP40**  
recessed compartment IP rate **IP20**  
IK **IK02**

#### HOLE RECESS DIMENSIONS

hole recess diameter **Ø 148 mm.**

#### ENERGY CLASSIFICATION



The lamps cannot be changed in the luminaire.

#### LED SOURCE DETAILS

led source type **CoB Led**  
LED brand **Bridgelux**  
LED current **1050 mA**  
LED voltage **36 V**  
Service lifetime **L80 / B20 - 50.000 h.**  
Light temperature **4000 K**  
CRI **CRI >90**  
SDCM **< 3**

#### DRIVER CHARACTERISTICS

driver **On+Off**  
Power factor **> 0,9**  
Operating temperature **-20°C ÷ 45°C**

### Nemo TL Fix

**RTT21436** - Trimless + Gold Reflector - 42 W - 3800 lumen / 4000 K / CRI >90

#### LIGHTING DETAILS

emission	<b>rotationally symmetrical</b>
luminous effect	<b>flood</b>
optic	<b>24°</b>
Beam angle - direct	<b>24°</b>
UGR	<b>≤ 17</b>
Cut Hood	<b>38°</b>

#### PHOTOMETRIC

