

Nemo TL Adj

RTT20230CA - Trimless + Mirror Reflector - 33 W - 3100 lumen / 4000 K / CRI >90

DESCRIPTION

Nemo TL is the trimless series of the Nemo family designed for installations in plasterboard false ceilings with no visible edge. Models up to 24W are equipped with a pre-drilled fixed frame for direct fixing of the luminaire to the false ceiling; The 33W and 42W models are equipped with height-adjustable fixing frame. Four beam openings with 38 ° cut-off and versions up to UGR <17 allow to obtain the right balance between luminance control and light diffusion. The lighting modules are all equipped with latest generation LEDs with CRI > 90 and SDCM <3. The range of Nemo TL Adj and Nemo TL Fix has interchangeable secondary reflectors available in five different aesthetic finishes that allow the system to be characterized even after the first installation. The safety cable supplied prevents accidental drops and the "fast plug" connection system to the driver allows quick and safe installation. Nemo ADJ version for accent lighting with 350 ° adjustability on the horizontal plane and 30 ° on the vertical plane. Nemo Fix is perfect for vertical lighting for the control of direct glare and soft light at the edges of the beam.



Switch

Casambi

PRODUCTS CHARACTERISTICS

installation type
material
Color
Power
Lumen output - Full emission
Efficacy
Diameter
Dimensions
net weight

trimless recessed
Aluminum
Mirror
33 W
3128 lm
95 lm/W
Ø 116 mm.
h 169 mm.
1,05 kg.

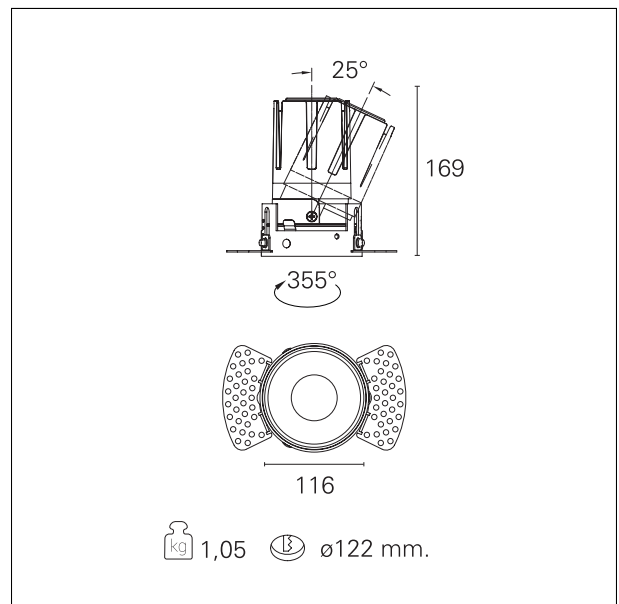

ELECTRICAL CHARACTERISTICS

feeding
driver

220÷240 V
Casambi

Nemo TL Adj

RTT20230CA - Trimless + Mirror Reflector - 33 W - 3100 lumen / 4000 K / CRI >90

Insulation class **Class II**

MECHANICAL CHARACTERISTICS

optical compartment IP rate **IP40**
recessed compartment IP rate **IP20**
IK **IK02**

HOLE RECESS DIMENSIONS

hole recess diameter **Ø 122 mm.**

ENERGY CLASSIFICATION



This luminaire contains built-in LED lamps.



The lamps cannot be changed in the luminaire.

LED SOURCE DETAILS

led source type **CoB Led**
LED brand **Bridgelux**
LED current **800 mA**
LED voltage **36 V**
Service lifetime **L80 / B20 - 50.000 h.**
Light temperature **4000 K**
CRI **CRI >90**
SDCM **< 3**

DRIVER CHARACTERISTICS

driver **Casambi**
Power factor **> 0,9**
Operating temperature **-20°C ÷ 45°C**

Nemo TL Adj

RTT20230CA - Trimless + Mirror Reflector - 33 W - 3100 lumen / 4000 K / CRI >90

LIGHTING DETAILS

emission	rotationally symmetrical
luminous effect	flood
optic	38°
Beam angle - direct	38°
UGR	≤ 19
Cut Hood	38°

PHOTOMETRIC

