

Pill

RTL48108 - 2,5 W / 3000 K / CRI >80

DESCRIPTION

Adjustable recessed luminaire for indoor installation. Black anodized aluminum body and steel springs fixing system. Three secondary optics (lenses) and two colour temperature available. Thanks to small height and the small dimensions it is ideal for lighting of display cases and niches, as well as for installation in shelves and everywhere it's required reduced thickness.



PRODUCTS CHARACTERISTICS

installation type	Recessed Spotlights
material	Aluminum
Finish	Anodized
Color	Black
Power	2,5 W
Lumen output - Full emission	270 lm
Efficacy	90 lm/W
Diameter	ø 60 mm.
net weight	0,09 kg.

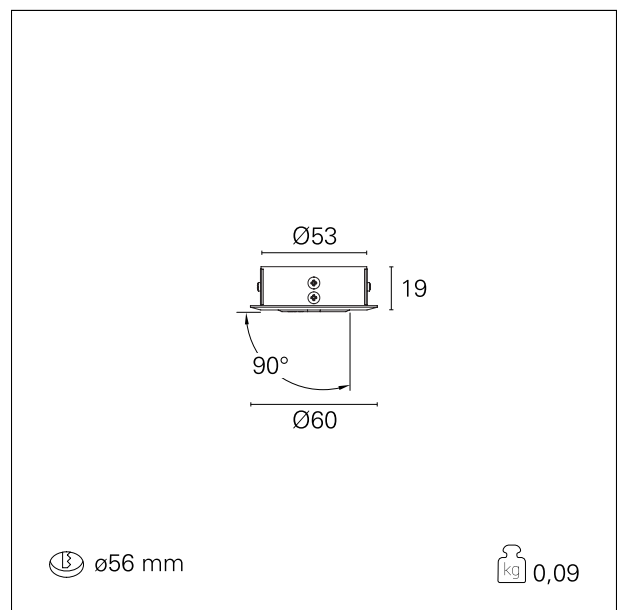

ELECTRICAL CHARACTERISTICS

feeding	700 mA CC
Insulation class	Class III

MECHANICAL CHARACTERISTICS

product IP rate	IP40
-----------------	-------------

Pill

RTL48108 - 2,5 W / 3000 K / CRI >80

HOLE RECESS DIMENSIONS

hole recess diameter **ø 56 mm.**

LED SOURCE DETAILS

led source type	Power Led
Photobiological risk	RG 2 Moderate risk (IEC 62471)
LED current	700 mA
Light temperature	3000 K
CRI	CRI >80

LIGHTING DETAILS

emission	rotationally symmetrical
luminous effect	flood
optic	25°
Beam angle - direct	25°

PHOTOMETRIC

