

Ska Base

RTL47308 - 33 W - 3200 lumen - 36° - Flood / 33 W / 4000 K / CRI > 92

DESCRIPTION

The SKA projectors are particularly suitable for the lighting of commercial environments such as shops and malls. The high lighting performance allows adequate illumination of the exhibition surfaces and exposed objects. The SKA projectors are equipped with selected drivers and CoB LEDs (prime brand) and the light color qualities (CRI > 90 and SDCM < 3) guarantee an excellent color rendering of the illuminated objects. The light emission is managed with high efficacy interchangeable optics to obtain maximum efficiency and maximum flexibility. Available On / Off and DALI versions.



Switch **On:Off**

PRODUCTS CHARACTERISTICS

installation type	Track / Ceiling projectors
material	Aluminum
Color	Black
Power	33 W
Lumen output - Full emission	3240 lm
Efficacy	98 lm/W
Dimensions	95 x 207 mm.
net weight	1,1 kg.

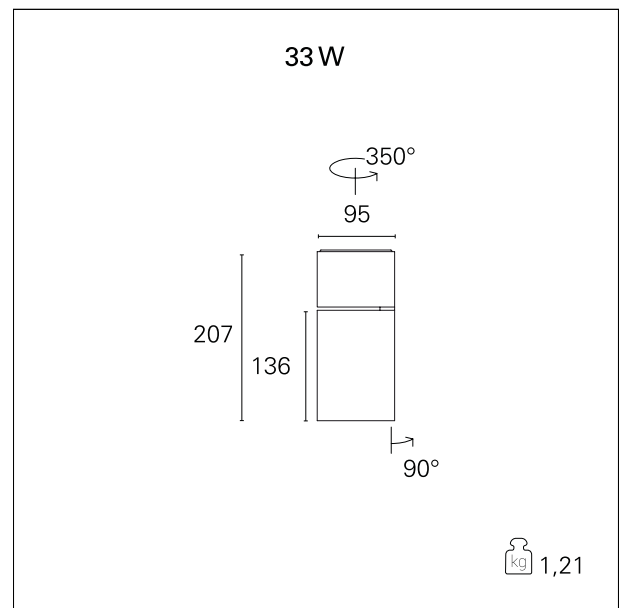

ELECTRICAL CHARACTERISTICS

feeding	220÷240 V
driver	On:Off
Insulation class	Class I

MECHANICAL CHARACTERISTICS

product IP rate	IP20
-----------------	-------------

Ska Base

RTL47308 - 33 W - 3200 lumen - 36° - Flood / 33 W / 4000 K / CRI > 92

LED SOURCE DETAILS

led source type	CoB Led
Photobiological risk	RG 1 Low risk (IEC 62471)
LED brand	Bridgelux or equivalent
LED current	800 mA
Service lifetime	L80 / B20 - 50.000 h.
Light temperature	4000 K
CRI	CRI > 92
SDCM	< 3

DRIVER CHARACTERISTICS

driver	On÷Off
Operating temperature	-20°C ÷ 45°C

LIGHTING DETAILS

luminous effect	flood
Beam angle - direct	36°
Cut Hood	32°

PHOTOMETRIC

