

Ska

RTL46311DA - 33 W - 3200 lumen - 60° - Wide / 33 W / 4000 K / CRI > 92

DESCRIPTION

The SKA projectors are particularly suitable for the lighting of commercial environments such as shops and malls. The high lighting performance allows adequate illumination of the exhibition surfaces and exposed objects. The SKA projectors are equipped with selected drivers and CoB LEDs (prime brand) and the light color qualities (CRI > 90 and SDCM < 3) guarantee an excellent color rendering of the illuminated objects. The light emission is managed with high efficacy interchangeable optics to obtain maximum efficiency and maximum flexibility. Available On / Off and DALI versions.



Switch

DALI

PRODUCTS CHARACTERISTICS

installation type	Track / Ceiling projectors
material	Aluminum
Color	White
Power	33 W
Lumen output - Full emission	3240 lm
Efficacy	98 lm/W
Dimensions	152 x 204 mm.
net weight	1,1 kg.

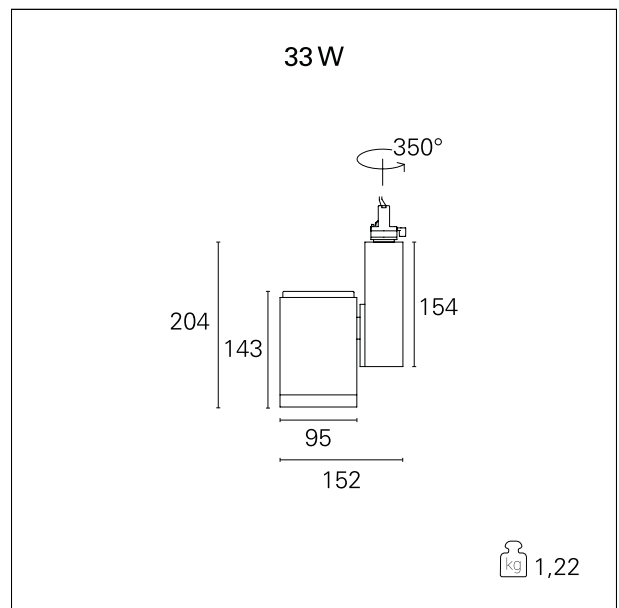

ELECTRICAL CHARACTERISTICS

feeding	220÷240 V
driver	DALI
Insulation class	Class I

MECHANICAL CHARACTERISTICS

product IP rate	IP20
-----------------	-------------

Ska

RTL46311DA - 33 W - 3200 lumen - 60° - Wide / 33 W / 4000 K / CRI > 92

ENERGY CLASSIFICATION



This luminaire contains built-in LED lamps.



The lamps cannot be changed in the luminaire.

LED SOURCE DETAILS

led source type	CoB Led
LED brand	Bridgelux or equivalent
LED current	800 mA
Service lifetime	L80 / B20 - 50.000 h.
Light temperature	4000 K
CRI	CRI > 92
SDCM	< 3

DRIVER CHARACTERISTICS

driver	DALI
Operating temperature	-20°C ÷ 45°C

LIGHTING DETAILS

luminous effect	wide
Beam angle - direct	60°
Cut Hood	32°

Ska

RTL46311DA - 33 W - 3200 lumen - 60° - Wide / 33 W / 4000 K / CRI > 92

PHOTOMETRIC

