

### Ska

**RTL46301DA** - 33 W - 3200 lumen - 15° - Spot / 33 W / 3000 K / CRI > 92

#### DESCRIPTION

The SKA projectors are particularly suitable for the lighting of commercial environments such as shops and malls. The high lighting performance allows adequate illumination of the exhibition surfaces and exposed objects. The SKA projectors are equipped with selected drivers and CoB LEDs (prime brand) and the light color qualities (CRI > 90 and SDCM < 3) guarantee an excellent color rendering of the illuminated objects. The light emission is managed with high efficacy interchangeable optics to obtain maximum efficiency and maximum flexibility. Available On / Off and DALI versions.



Switch

**DALI**

#### PRODUCTS CHARACTERISTICS

|                              |                                   |
|------------------------------|-----------------------------------|
| installation type            | <b>Track / Ceiling projectors</b> |
| material                     | <b>Aluminum</b>                   |
| Color                        | <b>White</b>                      |
| Power                        | <b>33 W</b>                       |
| Lumen output - Full emission | <b>3164 lm</b>                    |
| Efficacy                     | <b>96 lm/W</b>                    |
| Dimensions                   | <b>152 x 204 mm.</b>              |
| net weight                   | <b>1,1 kg.</b>                    |

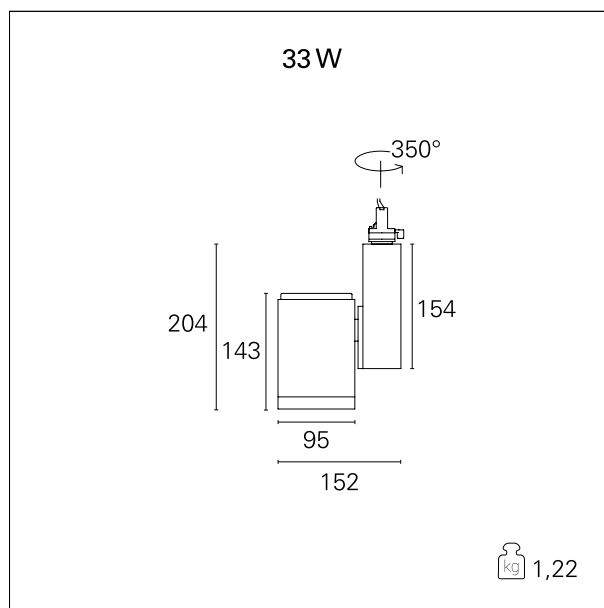

#### ELECTRICAL CHARACTERISTICS

|                  |                  |
|------------------|------------------|
| feeding          | <b>220÷240 V</b> |
| driver           | <b>DALI</b>      |
| Insulation class | <b>Class I</b>   |

#### MECHANICAL CHARACTERISTICS

|                 |             |
|-----------------|-------------|
| product IP rate | <b>IP20</b> |
|-----------------|-------------|

### Ska

**RTL46301DA** - 33 W - 3200 lumen - 15° - Spot / 33 W / 3000 K / CRI > 92

#### ENERGY CLASSIFICATION



This luminaire contains built-in LED lamps.



The lamps cannot be changed in the luminaire.

#### LED SOURCE DETAILS

|                   |                                |
|-------------------|--------------------------------|
| led source type   | <b>CoB Led</b>                 |
| LED brand         | <b>Bridgelux or equivalent</b> |
| LED current       | <b>800 mA</b>                  |
| Service lifetime  | <b>L80 / B20 - 50.000 h.</b>   |
| Light temperature | <b>3000 K</b>                  |
| CRI               | <b>CRI &gt; 92</b>             |
| SDCM              | <b>&lt; 3</b>                  |

#### DRIVER CHARACTERISTICS

|                       |                     |
|-----------------------|---------------------|
| driver                | <b>DALI</b>         |
| Operating temperature | <b>-20°C ÷ 45°C</b> |

#### LIGHTING DETAILS

|                     |             |
|---------------------|-------------|
| luminous effect     | <b>spot</b> |
| Beam angle - direct | <b>15°</b>  |
| Cut Hood            | <b>32°</b>  |

### Ska

RTL46301DA - 33 W - 3200 lumen - 15° - Spot / 33 W / 3000 K / CRI > 92

### PHOTOMETRIC

