

### Ska

**RTL46103** - 12 W - 1150 lumen - 15° - Spot / 12 W / 4000 K / CRI > 92

#### DESCRIPTION

The SKA projectors are particularly suitable for the lighting of commercial environments such as shops and malls. The high lighting performance allows adequate illumination of the exhibition surfaces and exposed objects. The SKA projectors are equipped with selected drivers and CoB LEDs (prime brand) and the light color qualities (CRI > 90 and SDCM < 3) guarantee an excellent color rendering of the illuminated objects. The light emission is managed with high efficacy interchangeable optics to obtain maximum efficiency and maximum flexibility. Available On / Off and DALI versions.



Switch **On:Off**

#### PRODUCTS CHARACTERISTICS

installation type	<b>Track / Ceiling projectors</b>
material	<b>Aluminum</b>
Color	<b>White</b>
Power	<b>12 W</b>
Lumen output - Full emission	<b>1160 lm</b>
Efficacy	<b>97 lm/W</b>
Dimensions	<b>103 x 162 mm.</b>
net weight	<b>0,55 kg.</b>

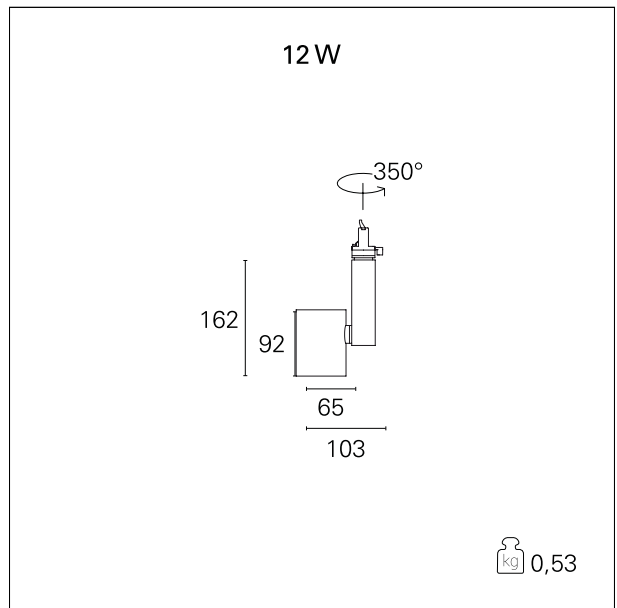

#### ELECTRICAL CHARACTERISTICS

feeding	<b>220÷240 V</b>
driver	<b>On:Off</b>
Insulation class	<b>Class I</b>

#### MECHANICAL CHARACTERISTICS

product IP rate	<b>IP20</b>
-----------------	-------------

### Ska

**RTL46103** - 12 W - 1150 lumen - 15° - Spot / 12 W / 4000 K / CRI > 92

#### ENERGY CLASSIFICATION



This luminaire contains built-in LED lamps.



The lamps cannot be changed in the luminaire.

#### LED SOURCE DETAILS

led source type	<b>CoB Led</b>
LED brand	<b>Bridgelux or equivalent</b>
LED current	<b>350 mA</b>
Service lifetime	<b>L80 / B20 - 50.000 h.</b>
Light temperature	<b>4000 K</b>
CRI	<b>CRI &gt; 92</b>
SDCM	<b>&lt; 3</b>

#### DRIVER CHARACTERISTICS

driver	<b>On÷Off</b>
Operating temperature	<b>-20°C ÷ 45°C</b>

#### LIGHTING DETAILS

luminous effect	<b>spot</b>
Beam angle - direct	<b>15°</b>
Cut Hood	<b>32°</b>

### Ska

RTL46103 - 12 W - 1150 lumen - 15° - Spot / 12 W / 4000 K / CRI > 92

### PHOTOMETRIC

