

Slim

RTL43311DA - 33 W - 3100 lumen - 36° - Flood / 33 W / 4000 K / CRI > 90

DESCRIPTION

The Slim series projectors are compact and “on board” driver equipped for an extremely clean and essential design. The light emitted stands out for its excellent beam diffusion and high color quality (CRI > 90 / MacAdam < 3). These characteristics make them particularly suitable for lighting for shops, exhibition areas and all those environments where the color rendering and the quality of the light beams are fundamental requirements. The interchangeable optics are semidiffused and the direct glare is totally controlled thanks to the deep shielding with a cut-off of 36° that characterizes the front end.



Switch

DALI

PRODUCTS CHARACTERISTICS

installation type

Track / Ceiling projectors

material

Aluminum

Color

White

Power

33 W

Lumen output - Full emission

3108 lm

Efficacy

94 lm/W

Dimensions

72 x 242 mm.

net weight

0,61 kg.

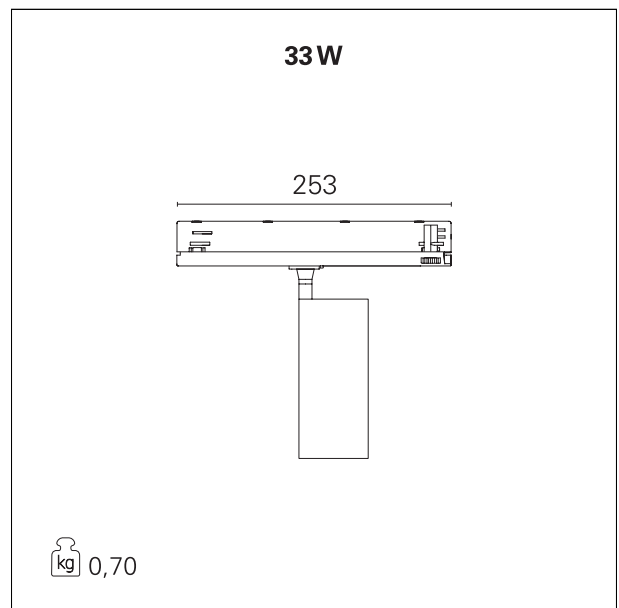

ELECTRICAL CHARACTERISTICS

feeding

220÷240 V

driver

DALI

Insulation class

Class I

MECHANICAL CHARACTERISTICS

product IP rate

IP20

IK

IK02

Slim

RTL43311DA - 33 W - 3100 lumen - 36° - Flood / 33 W / 4000 K / CRI > 90

LED SOURCE DETAILS

led source type	CoB Led
Photobiological risk	RG 2 Moderate risk (IEC 62471)
LED brand	Cree or equivalent
LED current	800 mA
LED voltage	37 V
Service lifetime	L80 / B20 - 50.000 h.
Light temperature	4000 K
CRI	CRI > 90
SDCM	< 3

DRIVER CHARACTERISTICS

driver	DALI
Power factor	> 0,9
Operating temperature	-20°C ÷ 50°C

LIGHTING DETAILS

luminous effect	flood
Beam angle - direct	36°
Cut Hood	36°

PHOTOMETRIC

