

### Slim

**RTL43310DA** - 33 W - 3100 lumen - 36° - Flood / 33 W / 3000 K / CRI > 90

#### DESCRIPTION

The Slim series projectors are compact and “on board” driver equipped for an extremely clean and essential design. The light emitted stands out for its excellent beam diffusion and high color quality (CRI > 90 / MacAdam < 3). These characteristics make them particularly suitable for lighting for shops, exhibition areas and all those environments where the color rendering and the quality of the light beams are fundamental requirements. The interchangeable optics are semidiffused and the direct glare is totally controlled thanks to the deep shielding with a cut-off of 36° that characterizes the front end.



Switch

**DALI**

#### PRODUCTS CHARACTERISTICS

installation type

**Track / Ceiling projectors**

material

**Aluminum**

Color

**Black**

Power

**33 W**

Lumen output - Full emission

**3094 lm**

Efficacy

**94 lm/W**

Dimensions

**72 x 242 mm.**

net weight

**0,61 kg.**

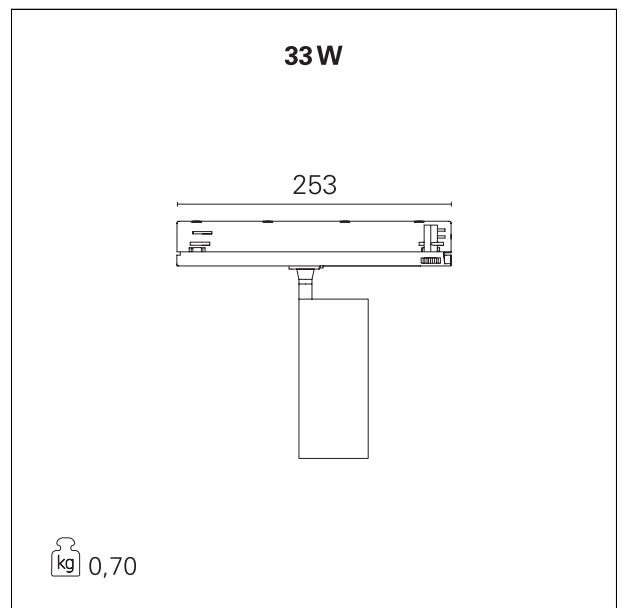

#### ELECTRICAL CHARACTERISTICS

feeding

**220÷240 V**

driver

**DALI**

Insulation class

**Class I**

#### MECHANICAL CHARACTERISTICS

product IP rate

**IP20**

IK

**IK02**

### Slim

**RTL43310DA** - 33 W - 3100 lumen - 36° - Flood / 33 W / 3000 K / CRI > 90

#### LED SOURCE DETAILS

led source type	<b>CoB Led</b>
Photobiological risk	<b>RG 2 Moderate risk ( IEC 62471 )</b>
LED brand	<b>Cree or equivalent</b>
LED current	<b>800 mA</b>
LED voltage	<b>37 V</b>
Service lifetime	<b>L80 / B20 - 50.000 h.</b>
Light temperature	<b>3000 K</b>
CRI	<b>CRI &gt; 90</b>
SDCM	<b>&lt; 3</b>

#### DRIVER CHARACTERISTICS

driver	<b>DALI</b>
Power factor	<b>&gt; 0,9</b>
Operating temperature	<b>-20°C ÷ 50°C</b>

#### LIGHTING DETAILS

luminous effect	<b>flood</b>
Beam angle - direct	<b>36°</b>
Cut Hood	<b>36°</b>

#### PHOTOMETRIC

