

Slim

RTL43103DA - 12 W - 1100 lumen - 15° - Spot / 12 W / 4000 K / CRI > 90

DESCRIPTION

The Slim series projectors are compact and “on board” driver equipped for an extremely clean and essential design. The light emitted stands out for its excellent beam diffusion and high color quality (CRI > 90 / MacAdam < 3). These characteristics make them particularly suitable for lighting for shops, exhibition areas and all those environments where the color rendering and the quality of the light beams are fundamental requirements. The interchangeable optics are semidiffused and the direct glare is totally controlled thanks to the deep shielding with a cut-off of 36° that characterizes the front end.



Switch

DALI

PRODUCTS CHARACTERISTICS

installation type	Track / Ceiling projectors
material	Aluminum
Color	White
Power	12 W
Lumen output - Full emission	1110 lm
Efficacy	93 lm/W
Dimensions	52 x 214 mm.
net weight	0,35 kg.

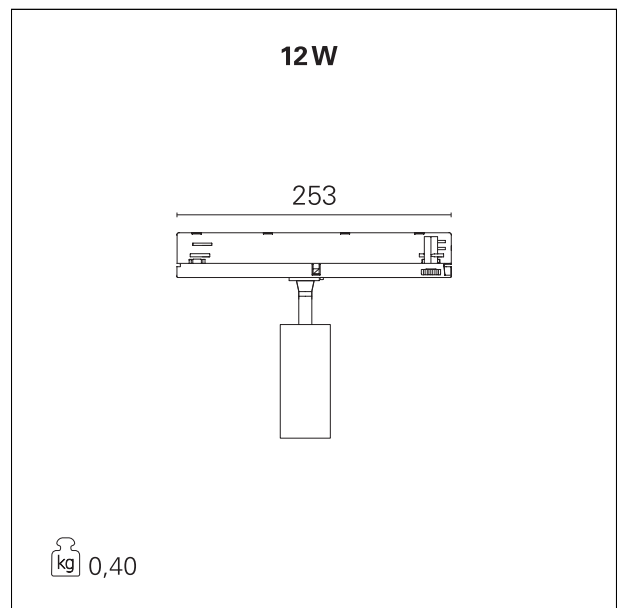

ELECTRICAL CHARACTERISTICS

feeding	220÷240 V
driver	DALI
Insulation class	Class I

MECHANICAL CHARACTERISTICS

product IP rate	IP20
IK	IK02

Slim

RTL43103DA - 12 W - 1100 lumen - 15° - Spot / 12 W / 4000 K / CRI > 90

LED SOURCE DETAILS

led source type	CoB Led
Photobiological risk	RG 2 Moderate risk (IEC 62471)
LED brand	Cree or equivalent
LED current	300 mA
LED voltage	37 V
Service lifetime	L80 / B20 - 50.000 h.
Light temperature	4000 K
CRI	CRI > 90
SDCM	< 3

DRIVER CHARACTERISTICS

driver	DALI
Power factor	> 0,5
Operating temperature	-20°C ÷ 45°C

LIGHTING DETAILS

luminous effect	spot
Beam angle - direct	15°
Cut Hood	36°

PHOTOMETRIC

