

Moby

RTL30304DA - 33 W / 4000 K / CRI >90

DESCRIPTION

Projectors of the Moby series are designed to illuminate the display areas of commercial environments and shops: they are equipped with high efficiency electronic drivers and high color rendering CoB LEDs (CRI > 90 and SDCM < 3) to enhance the colors of the illuminated objects thanks to an intense and bright light. The optical groups are made by combining specific lenses with mirrored reflectors with curved and progressive facets, in order to have a high optical efficiency with a perfect light diffusion. The Moby projectors offer the possibility of extracting the optical body or moving it back into the false ceiling, thus allowing maximum flexibility and orientation in pointing. The connection with the driver is of the "fast plug" type and the fixing clips allow a tool-free installation.



Switch

DALI

PRODUCTS CHARACTERISTICS

installation type	Recessed Spotlights
material	Aluminum
Color	White
Power	33 W
Lumen output - Full emission	3185 lm
Efficacy	97 lm/W
Diameter	ø 158 mm.
net weight	0,86 kg.

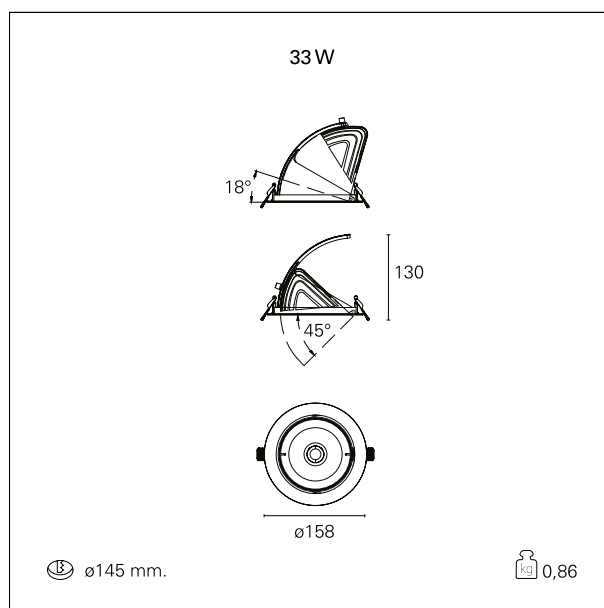

ELECTRICAL CHARACTERISTICS

feeding	220÷240 V
driver	DALI
Insulation class	Class II

MECHANICAL CHARACTERISTICS

Moby

RTL30304DA - 33 W / 4000 K / CRI >90

product IP rate **IP40**

HOLE RECESS DIMENSIONS

hole recess diameter **ø 145 mm.**

LED SOURCE DETAILS

led source type **CoB Led**
Photobiological risk **RG 1 Low risk (IEC 62471)**
LED brand **Bridgelux**
LED current **800 mA**
Service lifetime **L80 / B20 - 50.000 h.**
Light temperature **4000 K**
CRI **CRI >90**
SDCM **< 3**

DRIVER CHARACTERISTICS

driver **DALI**
Operating temperature **-20°C ÷ 45°C**

LIGHTING DETAILS

emission **rotationally symmetrical**
luminous effect **flood**
optic **24°**
Beam angle - direct **24°**

PHOTOMETRIC

Moby

RTL30304DA - 33 W / 4000 K / CRI >90

