

### Moby

RTL30301CA - 33 W / 3000 K / CRI >90

#### DESCRIPTION

Projectors of the Moby series are designed to illuminate the display areas of commercial environments and shops: they are equipped with high efficiency electronic drivers and high color rendering CoB LEDs (CRI > 90 and SDCM < 3) to enhance the colors of the illuminated objects thanks to an intense and bright light. The optical groups are made by combining specific lenses with mirrored reflectors with curved and progressive facets, in order to have a high optical efficiency with a perfect light diffusion. The Moby projectors offer the possibility of extracting the optical body or moving it back into the false ceiling, thus allowing maximum flexibility and orientation in pointing. The connection with the driver is of the "fast plug" type and the fixing clips allow a tool-free installation.



Switch

Casambi

#### PRODUCTS CHARACTERISTICS

installation type	<b>Recessed Spotlights</b>
material	<b>Aluminum</b>
Color	<b>White</b>
Power	<b>33 W</b>
Lumen output - Full emission	<b>3168 lm</b>
Efficacy	<b>96 lm/W</b>
Diameter	<b>ø 158 mm.</b>
net weight	<b>0,86 kg.</b>

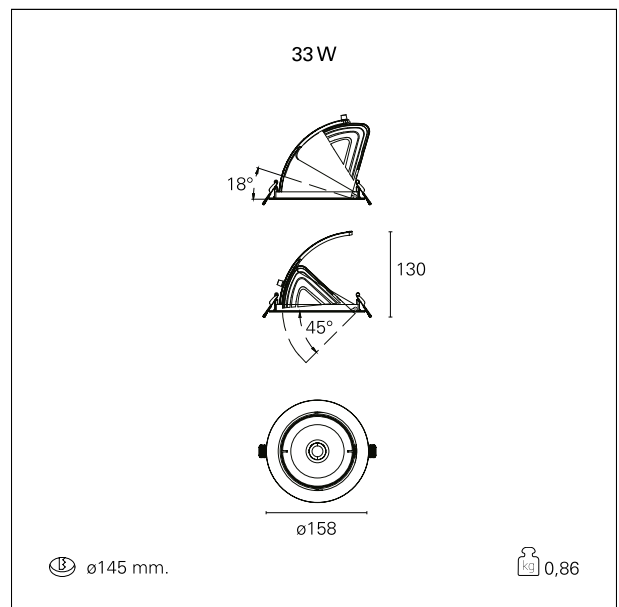

#### ELECTRICAL CHARACTERISTICS

feeding	<b>220÷240 V</b>
driver	<b>Casambi</b>
Insulation class	<b>Class II</b>

#### MECHANICAL CHARACTERISTICS

### Moby

**RTL30301CA** - 33 W / 3000 K / CRI >90

product IP rate **IP40**

#### HOLE RECESS DIMENSIONS

hole recess diameter **ø 145 mm.**

#### LED SOURCE DETAILS

led source type **CoB Led**  
Photobiological risk **RG 1 Low risk ( IEC 62471 )**  
LED brand **Bridgelux**  
LED current **800 mA**  
Service lifetime **L80 / B20 - 50.000 h.**  
Light temperature **3000 K**  
CRI **CRI >90**  
SDCM **< 3**

#### DRIVER CHARACTERISTICS

driver **Casambi**  
Operating temperature **-20°C ÷ 45°C**

#### LIGHTING DETAILS

emission **rotationally symmetrical**  
luminous effect **spot**  
optic **15°**  
Beam angle - direct **15°**

#### PHOTOMETRIC

### Moby

RTL30301CA - 33 W / 3000 K / CRI >90

