

Widot

RTL24552CA - 24 W / 2700 K / CRI > 90

DESCRIPTION

Widot is therefore particularly suitable for all those lighting systems where the fixtures must be installed in a white false ceiling without the plaster finishing; it is a recessed product characterized by its rounded housing that, completely white and curved inwards, ensures continuity with false ceiling without signs or differences in finishes. Quick and easy to install thanks to the fast coupling system and to the "fast plug" connector of the driver, Widot is the right solution for systems that need quick installation without renouncing the aesthetic and formal cleaning of visible parts. CoB leds are selected among prime brands and the four available optics enable the realization of different accent lighting effects for all the main lighting requirements. The asymmetric version completes the range, allows the lighting of the walls with "accent washing" effects. The asymmetrical version completes the range allowing the lighting of the walls with "accent washing" effects.



Switch

Casambi

PRODUCTS CHARACTERISTICS

installation type	Recessed projectors
material	Aluminum
Color	White
Power	24 W
Lumen output - Direct emission	2062 lm
Lumen output - Full emission	2062 lm
Efficacy	90 lm/W
Diameter	ø 110 mm.
Dimensions	h. 146 mm.
net weight	0,66 kg.

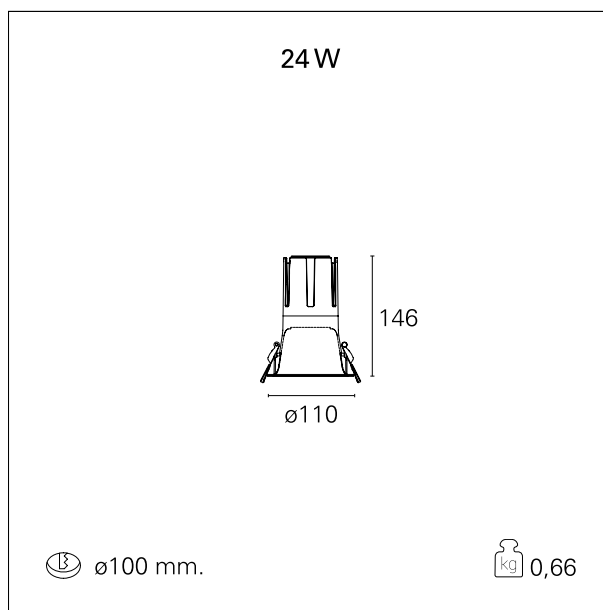

ELECTRICAL CHARACTERISTICS

feeding	220÷240 V
driver	Casambi
Insulation class	Class I

Widot

RTL24552CA - 24 W / 2700 K / CRI > 90

MECHANICAL CHARACTERISTICS

product IP rate	IP20
optical compartment IP rate	IP20
recessed compartment IP rate	IP20
IK	IK02

HOLE RECESS DIMENSIONS

hole recess diameter **ø 100 mm.**

ENERGY CLASSIFICATION



This luminaire contains built-in LED lamps.

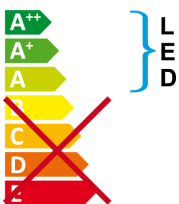

The lamps cannot be changed in the luminaire.

LED SOURCE DETAILS

led source type	CoB Led
LED brand	Bridgelux
LED current	600 mA
LED voltage	36 V
Energy class	LED
Service lifetime	L80 / B20 - 50.000 h.
Light temperature	2700 K
CRI	CRI > 90
SDCM	< 3

DRIVER CHARACTERISTICS

driver	Casambi
Power factor	> 0,9
Operating temperature	-20°C ÷ 45°C

LIGHTING DETAILS

Widot

RTL24552CA - 24 W / 2700 K / CRI > 90

emission

luminous effect

optic

Beam angle - direct

UGR

Cut Hood

Direct

Projected

55°

55°

≤ 21

48°

PHOTOMETRIC

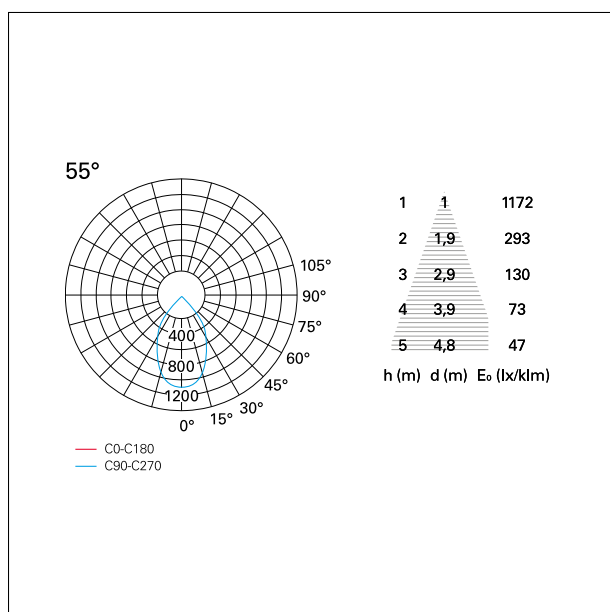

WARRANTY

period

5 years