

Widot

RTL24531CA - 33 W / 3000 K / CRI > 90

DESCRIPTION

Widot is therefore particularly suitable for all those lighting systems where the fixtures must be installed in a white false ceiling without the plaster finishing; it is a recessed product characterized by its rounded housing that, completely white and curved inwards, ensures continuity with false ceiling without signs or differences in finishes. Quick and easy to install thanks to the fast coupling system and to the "fast plug" connector of the driver, Widot is the right solution for systems that need quick installation without renouncing the aesthetic and formal cleaning of visible parts. CoB leds are selected among prime brands and the four available optics enable the realization of different accent lighting effects for all the main lighting requirements. The asymmetric version completes the range, allows the lighting of the walls with "accent washing" effects. The asymmetrical version completes the range allowing the lighting of the walls with "accent washing" effects.



Switch

Casambi

PRODUCTS CHARACTERISTICS

installation type	Proiettori Incassati
material	Alluminio
Color	Bianco
Power	33 W
Lumen output - Direct emission	3028 lm
Lumen output - Full emission	3028 lm
Efficacy	92 lm/W
Diameter	ø 138 mm.
Dimensions	h. 178 mm.
net weight	0,83 kg.

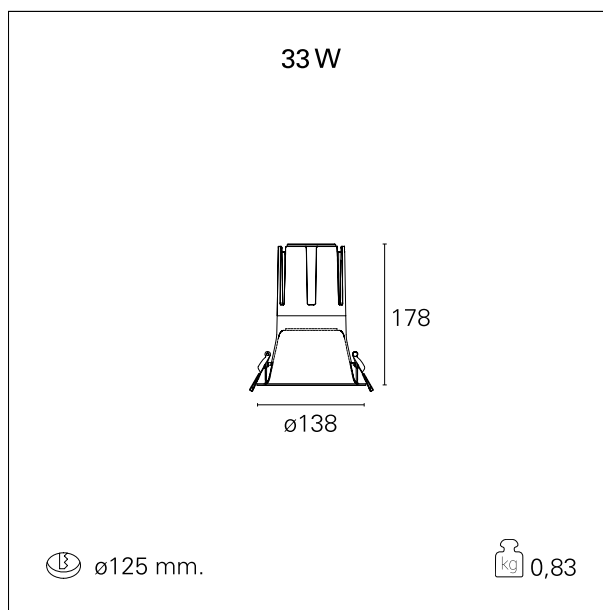

ELECTRICAL CHARACTERISTICS

feeding	220÷240 V
driver	Casambi
Insulation class	Classe I

Widot

RTL24531CA - 33 W / 3000 K / CRI > 90

MECHANICAL CHARACTERISTICS

product IP rate	IP20
optical compartment IP rate	IP20
recessed compartment IP rate	IP20
IK	IK02

HOLE RECESS DIMENSIONS

hole recess diameter **ø 125 mm.**

ENERGY CLASSIFICATION



This luminaire contains built-in LED lamps.

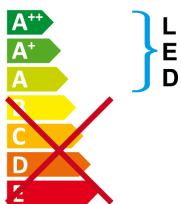

The lamps cannot be changed in the luminaire.

LED SOURCE DETAILS

led source type	CoB Led
LED brand	Bridgelux
LED current	800 mA
LED voltage	36 V
Energy class	LED
Service lifetime	L80 / B20 - 50.000 h.
Light temperature	3000 K
CRI	CRI > 90
SDCM	< 3

DRIVER CHARACTERISTICS

driver	Casambi
Power factor	> 0,9
Operating temperature	-20°C ÷ 45°C

LIGHTING DETAILS

Widot

RTL24531CA - 33 W / 3000 K / CRI > 90

emission

luminous effect

optic

Beam angle - direct

UGR

Cut Hood

Diretta

Proiettato

55°

55°

≤ 21

48°

PHOTOMETRIC

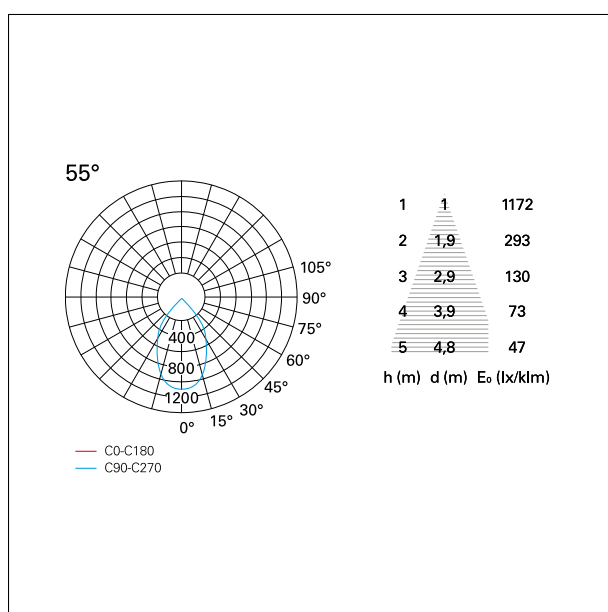

WARRANTY

period

5 years