

Widot

RTL24528DM - 33 W / 4000 K / CRI > 90

DESCRIPTION

Widot is therefore particularly suitable for all those lighting systems where the fixtures must be installed in a white false ceiling without the plaster finishing; it is a recessed product characterized by its rounded housing that, completely white and curved inwards, ensures continuity with false ceiling without signs or differences in finishes. Quick and easy to install thanks to the fast coupling system and to the "fast plug" connector of the driver, Widot is the right solution for systems that need quick installation without renouncing the aesthetic and formal cleaning of visible parts. CoB leds are selected among prime brands and the four available optics enable the realization of different accent lighting effects for all the main lighting requirements. The asymmetric version completes the range, allows the lighting of the walls with "accent washing" effects. The asymmetrical version completes the range allowing the lighting of the walls with "accent washing" effects.



Switch 1...10V / Push

PRODUCTS CHARACTERISTICS

| | |
|--------------------------------|-----------------------------|
| installation type | Proiettori Incassati |
| material | Alluminio |
| Color | Bianco |
| Power | 33 W |
| Lumen output - Direct emission | 3090 lm |
| Lumen output - Full emission | 3090 lm |
| Efficacy | 94 lm/W |
| Diameter | ø 138 mm. |
| Dimensions | h. 178 mm. |
| net weight | 0,83 kg. |

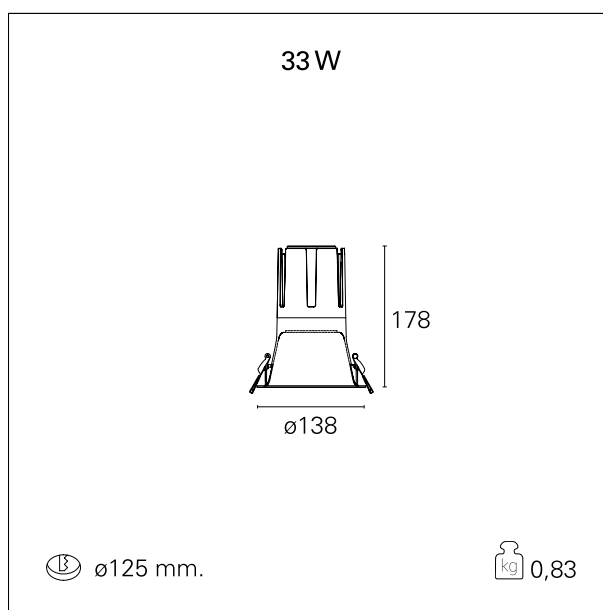

ELECTRICAL CHARACTERISTICS

| | |
|------------------|-----------------------|
| feeding | 220÷240 V |
| driver | 1...10V / Push |
| Insulation class | Classe I |

Widot

RTL24528DM - 33 W / 4000 K / CRI > 90

MECHANICAL CHARACTERISTICS

| | |
|------------------------------|-------------|
| product IP rate | IP20 |
| optical compartment IP rate | IP20 |
| recessed compartment IP rate | IP20 |
| IK | IK02 |

HOLE RECESS DIMENSIONS

| | |
|----------------------|------------------|
| hole recess diameter | ø 125 mm. |
|----------------------|------------------|

ENERGY CLASSIFICATION



This luminaire contains built-in LED lamps.

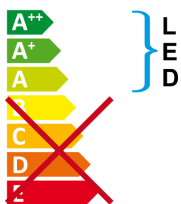

The lamps cannot be changed in the luminaire.

LED SOURCE DETAILS

| | |
|-------------------|------------------------------|
| led source type | CoB Led |
| LED brand | Bridgelux |
| LED current | 800 mA |
| LED voltage | 36 V |
| Energy class | LED |
| Service lifetime | L80 / B20 - 50.000 h. |
| Light temperature | 4000 K |
| CRI | CRI > 90 |
| SDCM | < 3 |

DRIVER CHARACTERISTICS

| | |
|-----------------------|-----------------------|
| driver | 1...10V / Push |
| Power factor | > 0,9 |
| Operating temperature | -20°C ÷ 45°C |

LIGHTING DETAILS

Widot

RTL24528DM - 33 W / 4000 K / CRI > 90

emission

luminous effect

optic

Beam angle - direct

UGR

Cut Hood

Diretta

Proiettato

24°

24°

≤ 19

48°

PHOTOMETRIC

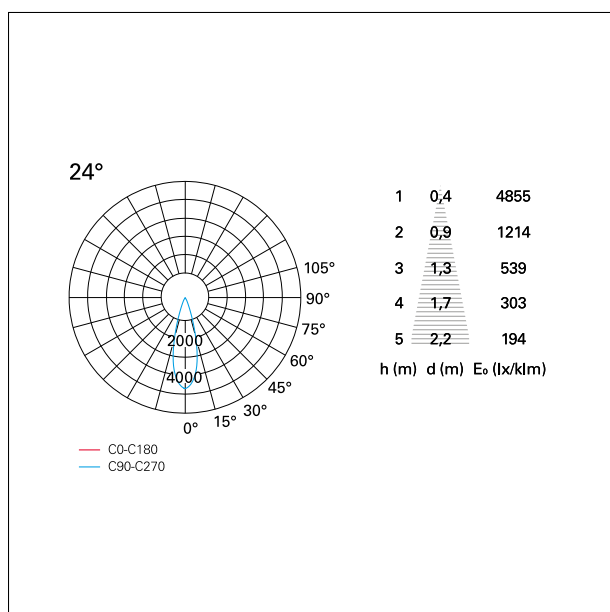

WARRANTY

period

5 years