

### Widot

RTL24522DM - 24 W / 4000 K / CRI > 90

#### DESCRIPTION

Widot is therefore particularly suitable for all those lighting systems where the fixtures must be installed in a white false ceiling without the plaster finishing; it is a recessed product characterized by its rounded housing that, completely white and curved inwards, ensures continuity with false ceiling without signs or differences in finishes. Quick and easy to install thanks to the fast coupling system and to the "fast plug" connector of the driver, Widot is the right solution for systems that need quick installation without renouncing the aesthetic and formal cleaning of visible parts. CoB leds are selected among prime brands and the four available optics enable the realization of different accent lighting effects for all the main lighting requirements. The asymmetric version completes the range, allows the lighting of the walls with "accent washing" effects. The asymmetrical version completes the range allowing the lighting of the walls with "accent washing" effects.



Switch 1...10V / Push

#### PRODUCTS CHARACTERISTICS

installation type	<b>Proiettori Incassati</b>
material	<b>Alluminio</b>
Color	<b>Bianco</b>
Power	<b>24 W</b>
Lumen output - Direct emission	<b>2180 lm</b>
Lumen output - Full emission	<b>2180 lm</b>
Efficacy	<b>91 lm/W</b>
Diameter	<b>ø 110 mm.</b>
Dimensions	<b>h. 146 mm.</b>
net weight	<b>0,66 kg.</b>

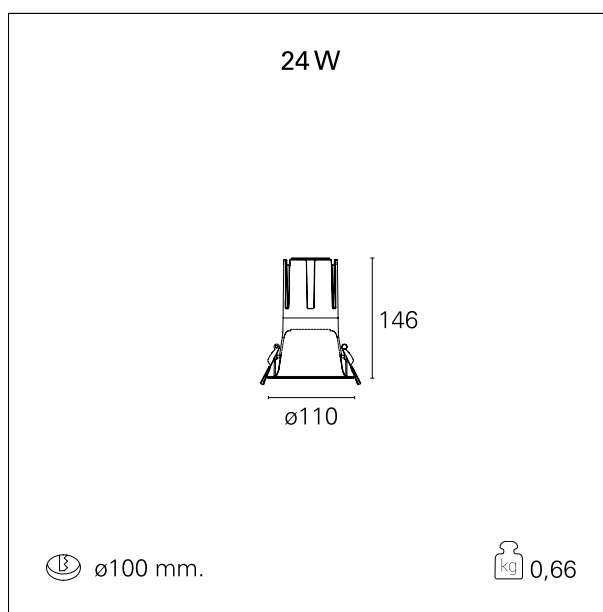

#### ELECTRICAL CHARACTERISTICS

feeding	<b>220÷240 V</b>
driver	<b>1...10V / Push</b>
Insulation class	<b>Classe I</b>

### Widot

RTL24522DM - 24 W / 4000 K / CRI > 90

#### MECHANICAL CHARACTERISTICS

product IP rate	<b>IP20</b>
optical compartment IP rate	<b>IP20</b>
recessed compartment IP rate	<b>IP20</b>
IK	<b>IK02</b>

#### HOLE RECESS DIMENSIONS

hole recess diameter	<b>ø 100 mm.</b>
----------------------	------------------

#### ENERGY CLASSIFICATION



This luminaire contains built-in LED lamps.

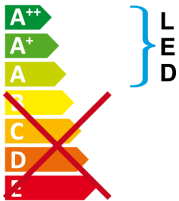

The lamps cannot be changed in the luminaire.

#### LED SOURCE DETAILS

led source type	<b>CoB Led</b>
LED brand	<b>Bridgelux</b>
LED current	<b>600 mA</b>
LED voltage	<b>36 V</b>
Energy class	<b>LED</b>
Service lifetime	<b>L80 / B20 - 50.000 h.</b>
Light temperature	<b>4000 K</b>
CRI	<b>CRI &gt; 90</b>
SDCM	<b>&lt; 3</b>

#### DRIVER CHARACTERISTICS

driver	<b>1...10V / Push</b>
Power factor	<b>&gt; 0,9</b>
Operating temperature	<b>-20°C ÷ 45°C</b>

#### LIGHTING DETAILS

### Widot

RTL24522DM - 24 W / 4000 K / CRI > 90

emission

luminous effect

optic

Beam angle - direct

UGR

Cut Hood

**Diretta**

**Proiettato**

**38°**

**38°**

**≤ 21**

**48°**

### PHOTOMETRIC

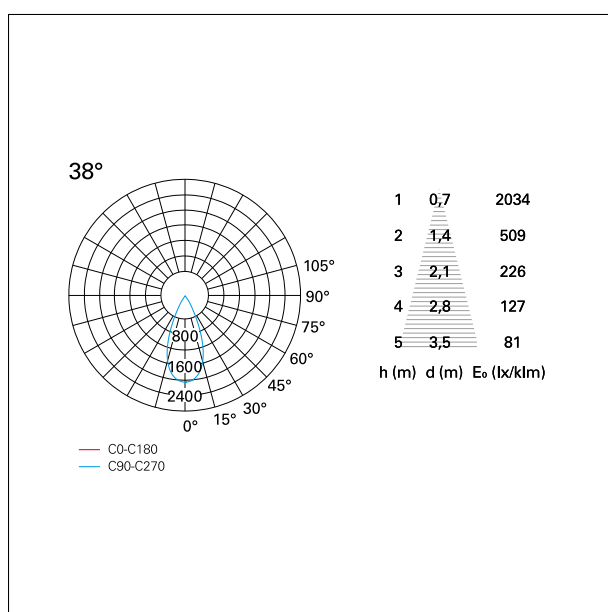

### WARRANTY

period

**5 years**