

### Accent Side

**RTL19426** - Squared Adjustable - 15 W - 1400 lumen / 3000 K / CRI >90

#### DESCRIPTION

Accent is the downlight equipped with the same LED modules of the Nemo series, it is ideal for all interior design projects where it is necessary to recreate well-defined light accents in the absence of glare. Accent has the LED source set back and completely hidden from view and with a 40 ° cut-off it offers maximum visual comfort by creating precise and well-defined uniform light accents. The Drop version is ideal for spot effects on the horizontal plane while the Side version allows you to tilt the optical module for lateral light emissions. All versions are installed in a Ø 65 mm recessed hole.



Switch

On:Off

#### PRODUCTS CHARACTERISTICS

installation type  
material  
Color  
Power  
Lumen output - Full emission  
Efficacy  
Dimensions

**trimmed recessed**  
**Aluminum**  
**White**  
**15 W**  
**1278 lm**  
**85 lm/W**  
**75 x 75 mm.**

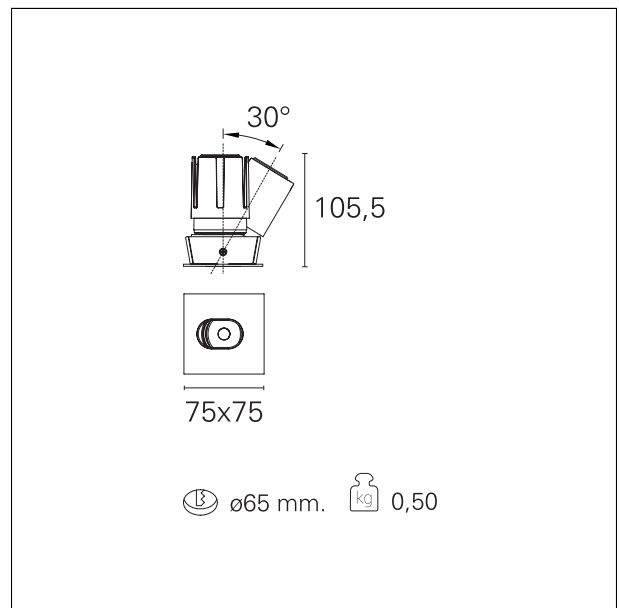

#### ELECTRICAL CHARACTERISTICS

feeding  
driver  
Insulation class

**220÷240 V**  
**On:Off**  
**Class II**

#### MECHANICAL CHARACTERISTICS

optical compartment IP rate  
recessed compartment IP rate

**IP40**  
**IP20**

### Accent Side

**RTL19426** - Squared Adjustable - 15 W - 1400 lumen / 3000 K / CRI >90

#### HOLE RECESS DIMENSIONS

hole recess diameter **Ø 65 mm.**

#### ENERGY CLASSIFICATION



This luminaire contains built-in LED lamps.

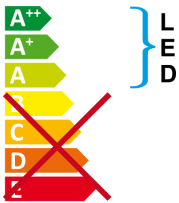

The lamps cannot be changed in the luminaire.

#### LED SOURCE DETAILS

led source type	<b>CoB Led</b>
LED brand	<b>Bridgelux</b>
LED current	<b>350 mA</b>
LED voltage	<b>36 V</b>
Service lifetime	<b>L80 / B20 - 50.000 h.</b>
Light temperature	<b>3000 K</b>
CRI	<b>CRI &gt;90</b>
SDCM	<b>&lt; 3</b>

#### DRIVER CHARACTERISTICS

driver	<b>On+Off</b>
Operating temperature	<b>-20°C ÷ 45°C</b>

#### LIGHTING DETAILS

emission	<b>rotationally symmetrical</b>
luminous effect	<b>flood</b>
optic	<b>32°</b>
Beam angle - direct	<b>32°</b>
UGR	<b>&lt; 17</b>
Cut Hood	<b>40°</b>

### Accent Side

RTL19426 - Squared Adjustable - 15 W - 1400 lumen / 3000 K / CRI >90

### PHOTOMETRIC

