

Accent Side

RTL19418PD - Squared Adjustable - 10 W - 900 lumen / 4000 K / CRI >90

DESCRIPTION

Accent is the downlight equipped with the same LED modules of the Nemo series, it is ideal for all interior design projects where it is necessary to recreate well-defined light accents in the absence of glare. Accent has the LED source set back and completely hidden from view and with a 40 ° cut-off it offers maximum visual comfort by creating precise and well-defined uniform light accents. The Drop version is ideal for spot effects on the horizontal plane while the Side version allows you to tilt the optical module for lateral light emissions. All versions are installed in a Ø 65 mm recessed hole.



Switch

Pan Digital

PRODUCTS CHARACTERISTICS

installation type
material
Color
Power
Lumen output - Full emission
Efficacy
Dimensions

trimmed recessed
Aluminum
White
10 W
872 lm
87 lm/W
75 x 75 mm.

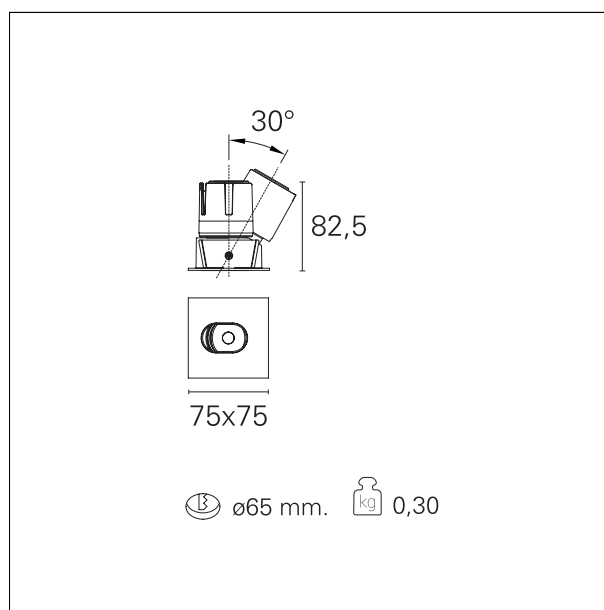

ELECTRICAL CHARACTERISTICS

feeding
driver
Insulation class

220÷240 V
Pan Digital
Class II

MECHANICAL CHARACTERISTICS

optical compartment IP rate
recessed compartment IP rate

IP40
IP20

Accent Side

RTL19418PD - Squared Adjustable - 10 W - 900 lumen / 4000 K / CRI >90

HOLE RECESS DIMENSIONS

hole recess diameter **Ø 65 mm.**

ENERGY CLASSIFICATION



This luminaire contains built-in LED lamps.

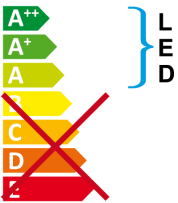

The lamps cannot be changed in the luminaire.

LED SOURCE DETAILS

led source type	CoB Led
LED brand	Bridgelux
LED current	250 mA
LED voltage	36 V
Service lifetime	L80 / B20 - 50.000 h.
Light temperature	4000 K
CRI	CRI >90
SDCM	< 3

DRIVER CHARACTERISTICS

driver	Pan Digital
Operating temperature	-20°C ÷ 45°C

LIGHTING DETAILS

emission	rotationally symmetrical
luminous effect	flood
optic	32°
Beam angle - direct	32°
UGR	< 16
Cut Hood	40°

Accent Side

RTL19418PD - Squared Adjustable - 10 W - 900 lumen / 4000 K / CRI >90

PHOTOMETRIC

