

Accent Drop

RTL19322DA - Squared Adjustable - 15 W - 1400 lumen / 2700 K / CRI >90

DESCRIPTION

Accent is the downlight equipped with the same LED modules of the Nemo series, it is ideal for all interior design projects where it is necessary to recreate well-defined light accents in the absence of glare. Accent has the LED source set back and completely hidden from view and with a 40 ° cut-off it offers maximum visual comfort by creating precise and well-defined uniform light accents. The Drop version is ideal for spot effects on the horizontal plane while the Side version allows you to tilt the optical module for lateral light emissions. All versions are installed in a Ø 65 mm recessed hole.



Switch

DALI

PRODUCTS CHARACTERISTICS

installation type	trimmed recessed
material	Aluminum
Color	White
Power	15 W
Lumen output - Full emission	1363 lm
Efficacy	91 lm/W
Dimensions	75 x 75 mm.

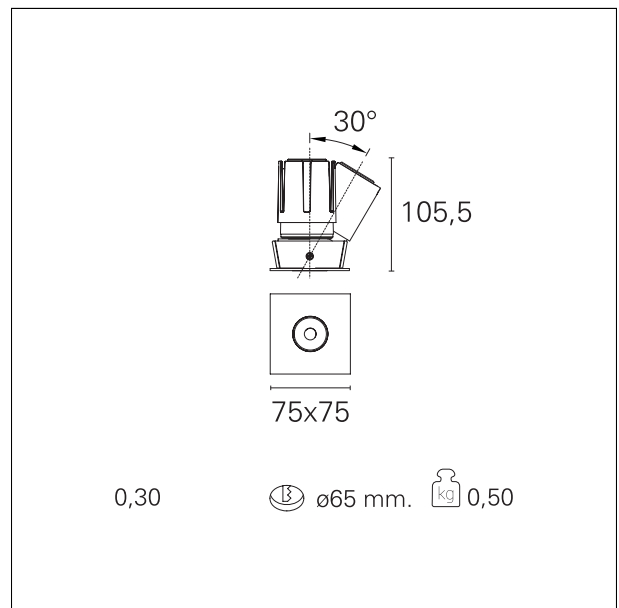

ELECTRICAL CHARACTERISTICS

feeding	220÷240 V
driver	DALI
Insulation class	Class II

MECHANICAL CHARACTERISTICS

optical compartment IP rate	IP40
recessed compartment IP rate	IP20

Accent Drop

RTL19322DA - Squared Adjustable - 15 W - 1400 lumen / 2700 K / CRI >90

HOLE RECESS DIMENSIONS

hole recess diameter **Ø 65 mm.**

ENERGY CLASSIFICATION



This luminaire contains built-in LED lamps.

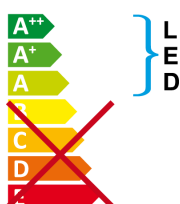

The lamps cannot be changed in the luminaire.

LED SOURCE DETAILS

led source type	CoB Led
LED brand	Bridgelux
LED current	350 mA
LED voltage	36 V
Service lifetime	L80 / B20 - 50.000 h.
Light temperature	2700 K
CRI	CRI >90
SDCM	< 3

DRIVER CHARACTERISTICS

driver	DALI
Operating temperature	-20°C ÷ 45°C

LIGHTING DETAILS

emission	rotationally symmetrical
luminous effect	flood
optic	24°
Beam angle - direct	24°
UGR	< 17
Cut Hood	40°

Accent Drop

RTL19322DA - Squared Adjustable - 15 W - 1400 lumen / 2700 K / CRI >90

PHOTOMETRIC

