

Accent Drop

RTL19314PD - Squared Adjustable - 10 W - 900 lumen / 3000 K / CRI >90

DESCRIPTION

Accent is the downlight equipped with the same LED modules of the Nemo series, it is ideal for all interior design projects where it is necessary to recreate well-defined light accents in the absence of glare. Accent has the LED source set back and completely hidden from view and with a 40 ° cut-off it offers maximum visual comfort by creating precise and well-defined uniform light accents. The Drop version is ideal for spot effects on the horizontal plane while the Side version allows you to tilt the optical module for lateral light emissions. All versions are installed in a Ø 65 mm recessed hole.



Switch

Pan Digital

PRODUCTS CHARACTERISTICS

installation type	trimmed recessed
material	Aluminum
Color	White
Power	10 W
Lumen output - Full emission	924 lm
Efficacy	92 lm/W
Dimensions	75 x 75 mm.

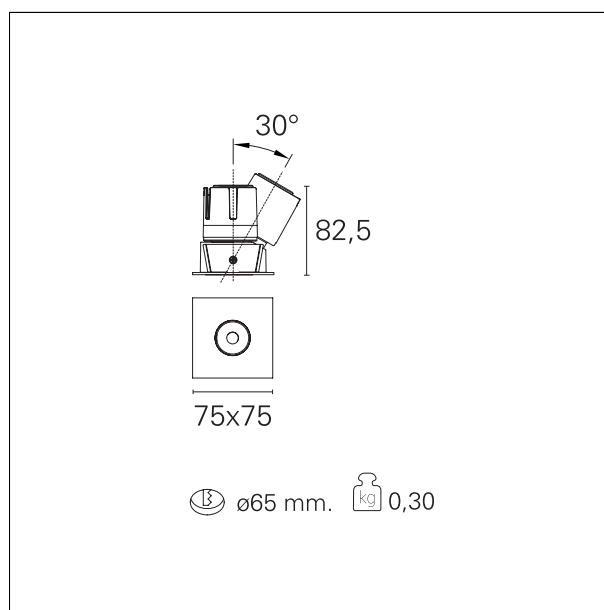

ELECTRICAL CHARACTERISTICS

feeding	220÷240 V
driver	Pan Digital
Insulation class	Class II

MECHANICAL CHARACTERISTICS

optical compartment IP rate	IP40
recessed compartment IP rate	IP20

Accent Drop

RTL19314PD - Squared Adjustable - 10 W - 900 lumen / 3000 K / CRI >90

HOLE RECESS DIMENSIONS

hole recess diameter **Ø 65 mm.**

ENERGY CLASSIFICATION



This luminaire contains built-in LED lamps.

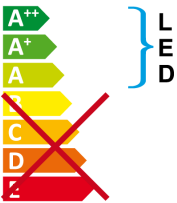

The lamps cannot be changed in the luminaire.

LED SOURCE DETAILS

led source type	CoB Led
LED brand	Bridgelux
LED current	250 mA
LED voltage	36 V
Service lifetime	L80 / B20 - 50.000 h.
Light temperature	3000 K
CRI	CRI >90
SDCM	< 3

DRIVER CHARACTERISTICS

driver	Pan Digital
Operating temperature	-20°C ÷ 45°C

LIGHTING DETAILS

emission	rotationally symmetrical
luminous effect	flood
optic	24°
Beam angle - direct	24°
UGR	< 16
Cut Hood	40°

Accent Drop

RTL19314PD - Squared Adjustable - 10 W - 900 lumen / 3000 K / CRI >90

PHOTOMETRIC

