

### Nemo IP54

RTL16221 - Squared - 15 W - 1450 lumen / 4000 K / CRI >90

#### DESCRIPTION

Nemo IP54 offers a complete range of optics and color temperatures and is the ideal solution for installations where it is necessary to protect the optical compartment and the LED source from dust and splashes of water. Equipped as standard with a prismatic glass, it diffuses the light optimally while maintaining all the chromatic characteristics given by the LED source (selected among the first brands).

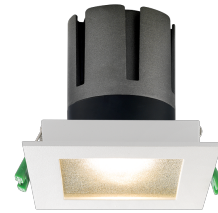

Switch

On+Off

#### PRODUCTS CHARACTERISTICS

installation type	<b>trimmed recessed</b>
material	<b>Aluminum</b>
Color	<b>White</b>
Power	<b>15 W</b>
Lumen output - Full emission	<b>1376 lm</b>
Efficacy	<b>92 lm/W</b>
Dimensions	<b>88 x 88 mm.</b>

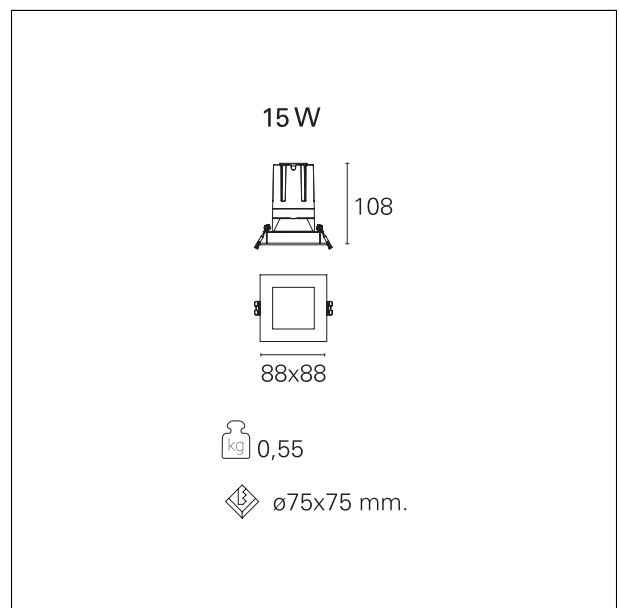

#### ELECTRICAL CHARACTERISTICS

feeding	<b>220÷240 V</b>
driver	<b>On+Off</b>
Insulation class	<b>Class II</b>

#### MECHANICAL CHARACTERISTICS

optical compartment IP rate	<b>IP54</b>
recessed compartment IP rate	<b>IP20</b>

### Nemo IP54

RTL16221 - Squared - 15 W - 1450 lumen / 4000 K / CRI >90

#### HOLE RECESS DIMENSIONS

a x b hole recess

**75 x 75 mm.**

#### ENERGY CLASSIFICATION



This luminaire contains built-in LED lamps.



The lamps cannot be changed in the luminaire.

#### LED SOURCE DETAILS

led source type	<b>CoB Led</b>
LED brand	<b>Bridgelux</b>
LED current	<b>350 mA</b>
LED voltage	<b>36 V</b>
Service lifetime	<b>L80 / B20 - 50.000 h.</b>
Light temperature	<b>4000 K</b>
CRI	<b>CRI &gt;90</b>
SDCM	<b>&lt; 3</b>

#### DRIVER CHARACTERISTICS

driver	<b>On÷Off</b>
Power factor	<b>&gt; 0,9</b>
Operating temperature	<b>-20°C ÷ 45°C</b>

#### LIGHTING DETAILS

emission	<b>rotationally symmetrical</b>
luminous effect	<b>flood</b>
optic	<b>24°</b>
Beam angle - direct	<b>24°</b>
UGR	<b>≤ 17</b>

### Nemo IP54

RTL16221 - Squared - 15 W - 1450 lumen / 4000 K / CRI >90

### PHOTOMETRIC

