

Nemo IP54

RTL16208DA - Squared - 10 W - 920 lumen / 3000 K / CRI >90

DESCRIPTION

Nemo IP54 offers a complete range of optics and color temperatures and is the ideal solution for installations where it is necessary to protect the optical compartment and the LED source from dust and splashes of water. Equipped as standard with a prismatic glass, it diffuses the light optimally while maintaining all the chromatic characteristics given by the LED source (selected among the first brands).

Switch

DALI



PRODUCTS CHARACTERISTICS

installation type	trimmed recessed
material	Aluminum
Color	White
Power	10 W
Lumen output - Full emission	845 lm
Efficacy	84 lm/W
Dimensions	88 x 88 mm.

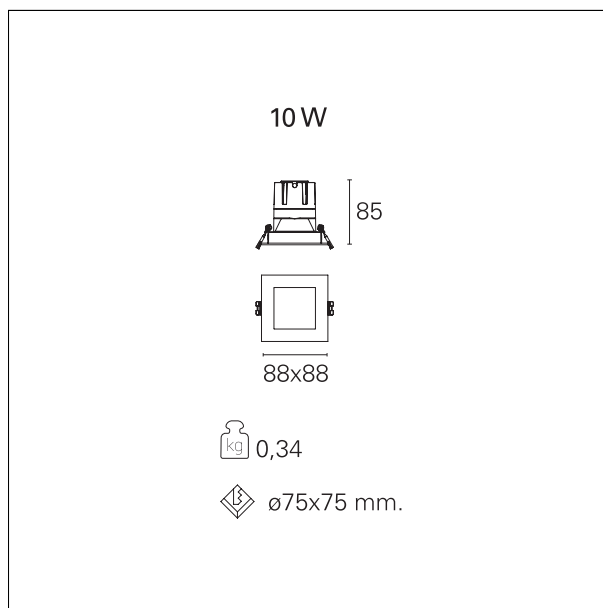

ELECTRICAL CHARACTERISTICS

feeding	220÷240 V
driver	DALI
Insulation class	Class II

MECHANICAL CHARACTERISTICS

optical compartment IP rate	IP54
recessed compartment IP rate	IP20

Nemo IP54

RTL16208DA - Squared - 10 W - 920 lumen / 3000 K / CRI >90

HOLE RECESS DIMENSIONS

a x b hole recess

75 x 75 mm.

ENERGY CLASSIFICATION



This luminaire contains built-in LED lamps.

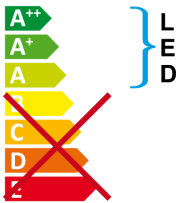

The lamps cannot be changed in the luminaire.

LED SOURCE DETAILS

led source type	CoB Led
LED brand	Bridgelux
LED current	250 mA
LED voltage	36 V
Service lifetime	L80 / B20 - 50.000 h.
Light temperature	3000 K
CRI	CRI >90
SDCM	< 3

DRIVER CHARACTERISTICS

driver	DALI
Power factor	> 0,5
Operating temperature	-20°C ÷ 45°C

LIGHTING DETAILS

emission	rotationally symmetrical
luminous effect	spot
optic	15°
Beam angle - direct	15°
UGR	≤ 19

Nemo IP54

RTL16208DA - Squared - 10 W - 920 lumen / 3000 K / CRI >90

PHOTOMETRIC

