

Bobby

RTL12222DM - 9 W / 4000 K / CRI >90

DESCRIPTION

Bobby is the ideal downlight for the punctual illumination of all environments with a UGR value of <19. Made in one piece, the die-cast aluminum body with integrated heat sink ensures maximum heat dissipation. With a complete range from 6W to 22W, Bobby is able to produce a bright and long-lasting light thanks to the "first choice" CoB LEDs (CRI > 90 and MacAdam index <3). The included "flicker free" driver completes the appliance making installation extremely simple and fast.



Switch 1...10V / Push

PRODUCTS CHARACTERISTICS

installation type	Recessed Spotlights
material	Aluminum
Finish	Painted
Color	White
Power	9 W
Lumen output - Full emission	720 lm
Efficacy	80 lm/W

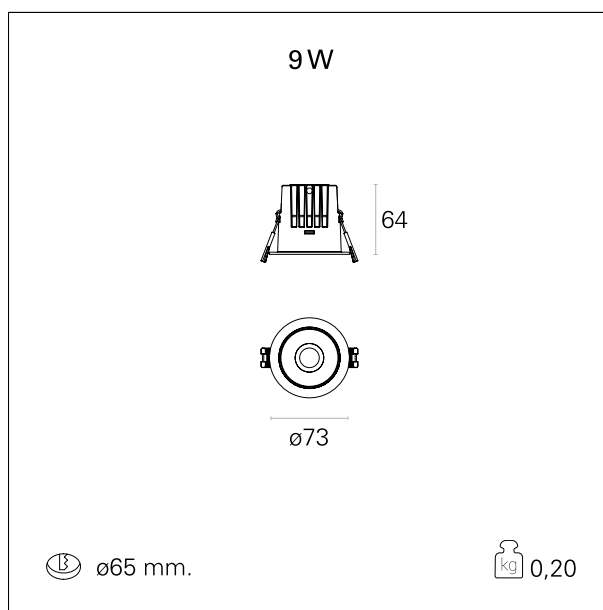

ELECTRICAL CHARACTERISTICS

feeding	220÷240 V
driver	1...10V / Push
Insulation class	Class II

MECHANICAL CHARACTERISTICS

optical compartment IP rate	IP40
recessed compartment IP rate	IP20

Bobby

RTL12222DM - 9 W / 4000 K / CRI >90

HOLE RECESS DIMENSIONS

hole recess diameter **ø 65 mm.**

LED SOURCE DETAILS

led source type	CoB Led
Photobiological risk	RG 1 Low risk (IEC 62471)
LED brand	Bridgelux
LED voltage	36 V
Service lifetime	L80 / B20 - 50.000 h.
Light temperature	4000 K
CRI	CRI >90
SDCM	< 3

DRIVER CHARACTERISTICS

driver	1...10V / Push
Operating temperature	-20°C ÷ 45°C

LIGHTING DETAILS

emission	rotationally symmetrical
luminous effect	flood
optic	38°
Beam angle - direct	38°
UGR	< 19

PHOTOMETRIC

Bobby

RTL12222DM - 9 W / 4000 K / CRI >90

