

Funky

PRJ10312 - 7 W - 440 lm. / 3000 K / CRI >80

DESCRIPTION

The Funky series includes a complete range of IP67 luminaires for the projection of light in outdoor. The range includes three different sizes and powers, all characterized by an extremely clean, minimal and easily camouflaged design; wired with H05RNF neoprene cable, the projectors are made in anodized aluminum and are complete with a 2 mm thick fixing bracket; this is equipped with a graduated ring for aiming adjustment. Funky projectors are equipped with high efficiency CoB drivers and LEDs and are complete with optical lenses with different beam apertures; They are therefore ideal for illuminating objects and architectural elements from a distance with precise accent lighting effects, or to obtain softly diffused grazing light effects on surfaces and facades. The Funky series is completed with a rich range of useful accessories both to solve different types of installation and to control glare.



PRODUCTS CHARACTERISTICS

installation type	Outdoor projectors
material	Aluminum
Finish	Anodized
Color	Black
Power	7 W
Lumen output - Full emission	325 lm
Efficacy	54 lm/W

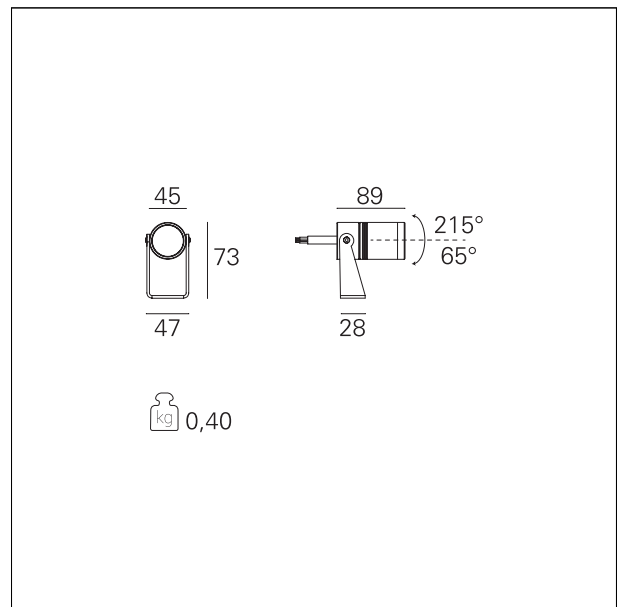

ELECTRICAL CHARACTERISTICS

feeding	220÷240 V
driver	On÷Off
Insulation class	Class I

Funky

PRJ10312 - 7 W - 440 lm. / 3000 K / CRI >80

MECHANICAL CHARACTERISTICS

product IP rate **IP67**

LED SOURCE DETAILS

led source type **CoB Led**
 Light source connection **LED**
 Service lifetime **L80 / B20 - 36.000 h.**
 Light temperature **3000 K**
 CRI **CRI >80**

LIGHTING DETAILS

optic **40°**

PHOTOMETRIC

