

Lybra

LNRO1022DA - Pendant - uplight/downlight - diffuser - 24+16 W - 4000 K / 4000 K / CRI > 80

DESCRIPTION

Thin, minimal and performing; Lybra is a linear suspension with reduced dimensions designed for the lighting of offices and commercial environments. Available in two different colors matt white and matt black, Lybra can be equipped with a diffuser for diffused light effects or with UGR <19 specular optics for the lighting of workspaces. Thanks to its bi-emission balanced between diffused light upwards and directed light downwards, Lybra guarantees a soft and comfortable light effect throughout the area and lights correctly the visual task.



Switch

DALI

PRODUCTS CHARACTERISTICS

installation type	Linear light
material	Aluminum
Finish	Painted
Color	Black
Power	24+16 W
Lumen output - Direct emission	2200 lm
Lumen output - Indirect emission	1950 lm
Lumen output - Full emission	4150 lm
Efficacy	104 lm/W
Dimensions	1126 mm

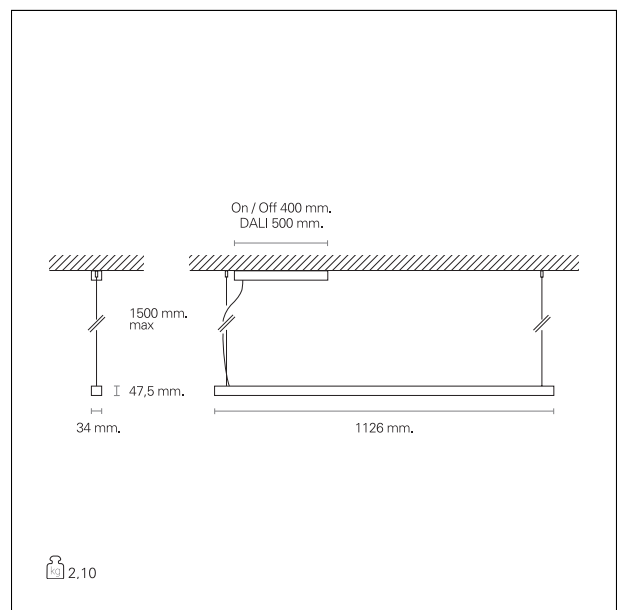

ELECTRICAL CHARACTERISTICS

feeding	220÷240 V
driver	DALI
Insulation class	Class I

MECHANICAL CHARACTERISTICS

product IP rate	IP20
-----------------	-------------

Lybra

LNRO1022DA - Pendant - uplight/downlight - diffuser - 24+16 W - 4000 K / 4000 K / CRI > 80

LED SOURCE DETAILS

led source type	Mid Power Led
Service lifetime	L80 / B10 - 36.000 h.
Light temperature	4000 K
CRI	CRI > 80
SDCM	< 3

DRIVER CHARACTERISTICS

driver	DALI
Lifetime	50.000 h

LIGHTING DETAILS

emission	uplight/downlight
Beam angle - direct	90°
Beam angle - indirect	80°
UGR	< 19

PHOTOMETRIC

