

Puck Plus

IND02005DA - Pendant High Bay - Ø 340 mm. - 200 W - 5000 K / 200 W / 5000 K / CRI > 80

DESCRIPTION

Suitable for lighting of indoor warehouses and production areas, Puck Plus is equipped with LEDs and DRIVER first label selection. Equipped with SMD LED and optical lenses. Versions available ON / OFF, dimmable 1 ... 10V, DALI. Die-cast aluminum body for optimization of heat dissipation. Suitable for ceiling or wall mounting using a brackets kit (to be ordered separately) or for suspension mounting using chains (not included). Rotosymmetric direct emission for controlled light. Optical shades as accessory. Microwave motion sensor for dimmable versions (accessory not included).



Switch **DALI**

PRODUCTS CHARACTERISTICS

installation type	High Bays
material	Aluminum die casting
Finish	Painted
Color	Black
Power	200 W
Lumen output - Full emission	26000 lm
Efficacy	130 lm/W
net weight	4,5 kg.

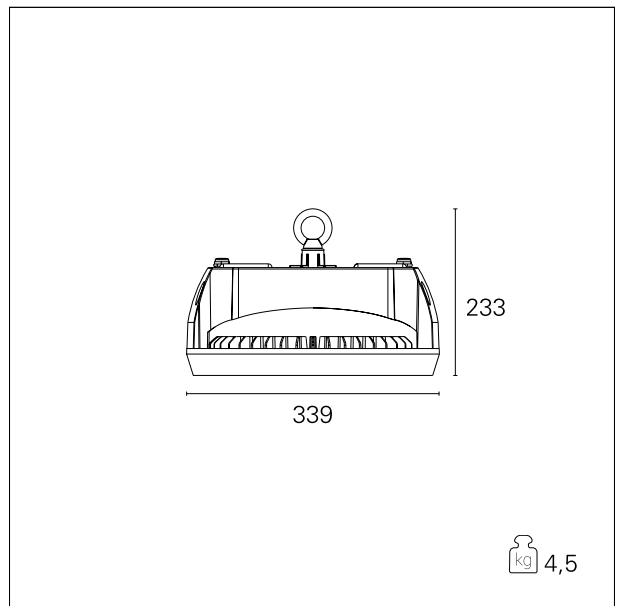

ELECTRICAL CHARACTERISTICS

feeding	220÷240 V
driver	DALI
Insulation class	Class I

MECHANICAL CHARACTERISTICS

product IP rate	IP65
IK	IK10

Puck Plus

IND02005DA - Pendant High Bay - Ø 340 mm. - 200 W - 5000 K / 200 W / 5000 K / CRI > 80

LED SOURCE DETAILS

led source type	SMD Led
Photobiological risk	RG 0 Exempt (IEC 62471)
LED brand	Philips or equivalent
Service lifetime	L70/B20 - 50.000 h.
Light temperature	5000 K
CRI	CRI > 80

DRIVER CHARACTERISTICS

driver	DALI
Power factor	> 0,95

LIGHTING DETAILS

emission	Downlight
optic	60°
UGR	< 22

PHOTOMETRIC

