

Puck Smart

IND01005 - Pendant High Bay - Ø 340 mm. - 200 W - 5000 K / 200 W / 5000 K / CRI > 80

DESCRIPTION

Suitable for indoor lighting of warehouses and production areas, the Puck Smart series is equipped with SMD LED sources and optical lenses. Die-cast aluminum body for the optimization of heat dissipation. Can be installed in suspension with cable or chain (not included) or on the ceiling and wall using an accessory bracket (to be ordered separately). Direct rotationally symmetrical emission for controlled light. Optical screens in accessory.

Switch

On+Off



PRODUCTS CHARACTERISTICS

installation type	High Bays
material	Aluminum die casting
Finish	Painted
Color	Black
Power	200 W
Lumen output - Full emission	24375 lm
Efficacy	122 lm/W
net weight	4,2 kg.

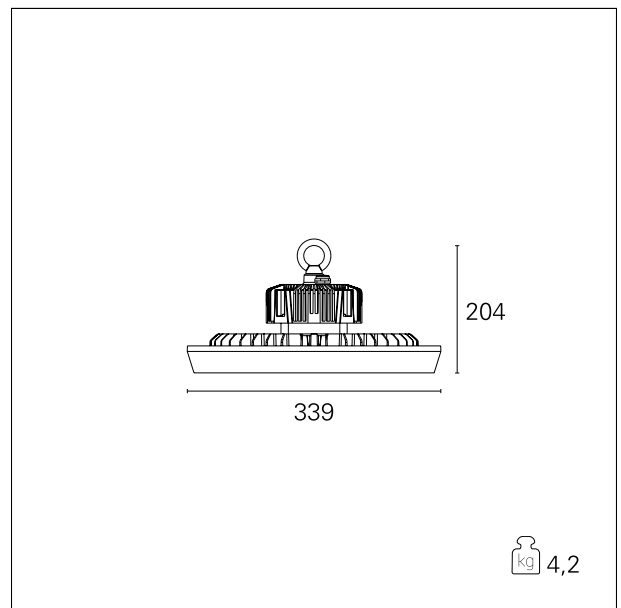

ELECTRICAL CHARACTERISTICS

feeding	220÷240 V
driver	On+Off
Insulation class	Class I

MECHANICAL CHARACTERISTICS

product IP rate	IP65
IK	IK10

Puck Smart

IND01005 - Pendant High Bay - Ø 340 mm. - 200 W - 5000 K / 200 W / 5000 K / CRI > 80

LED SOURCE DETAILS

led source type	SMD Led
Photobiological risk	RG 0 Exempt (IEC 62471)
Service lifetime	L70/B20 - 50.000 h.
Light temperature	5000 K
CRI	CRI > 80

DRIVER CHARACTERISTICS

driver	On÷Off
Power factor	> 0,95
Operating temperature	-30°C ÷ 45°C

LIGHTING DETAILS

emission	Downlight
optic	60°
UGR	< 22

PHOTOMETRIC

