

Shop

INC1347DA - 3x 15 W / 4000 K / CRI >90

DESCRIPTION

The Shop series consisting of a range of gimble projectors specifically designed for shop lighting and mounted on metallic modular plates. The plates, squared or rectangular, can be equipped with one, two or three projectors that can be oriented independently among them. This solution allows to group in a single light and in a single cut of the false ceiling more independent light sources saving on installation costs without renouncing the versatility of the system. The chromatic qualities of the LEDs used are CRI > 90 and SDCM < 3 and the fixing clips allow installation without tools.



Switch

DALI

PRODUCTS CHARACTERISTICS

installation type	Recessed Spotlights
material	Aluminum
Color	White
Power	3x 15 W
Lumen output - Full emission	4272 lm
Efficacy	93 lm/W
net weight	1,14 kg.

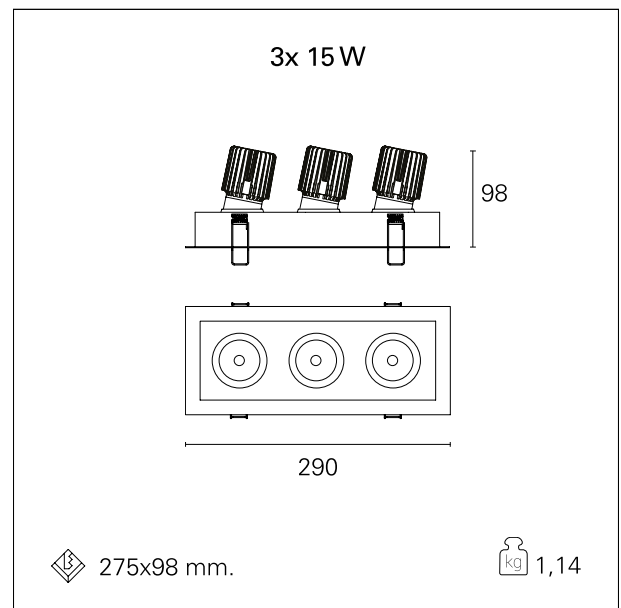

ELECTRICAL CHARACTERISTICS

feeding	220÷240 V
driver	DALI
Insulation class	Class II

MECHANICAL CHARACTERISTICS

optical compartment IP rate	IP40
recessed compartment IP rate	IP20

Shop

INC1347DA - 3x 15 W / 4000 K / CRI >90

HOLE RECESS DIMENSIONS

a x b hole recess **275 x 98 mm.**

LED SOURCE DETAILS

led source type	CoB Led
Photobiological risk	RG 1 Low risk (IEC 62471)
LED brand	Bridgelux
Service lifetime	L80 / B20 - 50.000 h.
Light temperature	4000 K
CRI	CRI >90
SDCM	< 3

DRIVER CHARACTERISTICS

driver **DALI**

LIGHTING DETAILS

emission	rotationally symmetrical
luminous effect	flood
optic	40°
Beam angle - direct	40°

PHOTOMETRIC

