

### Shop

**INC1345DA** - 15 W / 4000 K / CRI >90

#### DESCRIPTION

The Shop series consisting of a range of gimble projectors specifically designed for shop lighting and mounted on metallic modular plates. The plates, squared or rectangular, can be equipped with one, two or three projectors that can be oriented independently among them. This solution allows to group in a single light and in a single cut of the false ceiling more independent light sources saving on installation costs without renouncing the versatility of the system. The chromatic qualities of the LEDs used are CRI > 90 and SDCM < 3 and the fixing clips allow installation without tools.



Switch

**DALI**

#### PRODUCTS CHARACTERISTICS

installation type	<b>Recessed Spotlights</b>
material	<b>Aluminum</b>
Color	<b>White</b>
Power	<b>15 W</b>
Lumen output - Full emission	<b>1490 lm</b>
Efficacy	<b>93 lm/W</b>
net weight	<b>0,41 kg.</b>

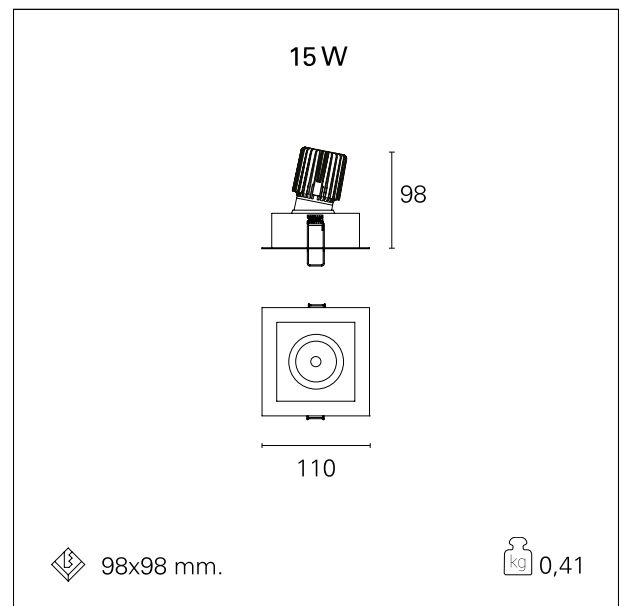

#### ELECTRICAL CHARACTERISTICS

feeding	<b>220÷240 V</b>
driver	<b>DALI</b>
Insulation class	<b>Class II</b>

#### MECHANICAL CHARACTERISTICS

optical compartment IP rate	<b>IP40</b>
recessed compartment IP rate	<b>IP20</b>

### Shop

**INC1345DA** - 15 W / 4000 K / CRI >90

### HOLE RECESS DIMENSIONS

a x b hole recess **98 x 98 mm.**

### LED SOURCE DETAILS

led source type	<b>CoB Led</b>
Photobiological risk	<b>RG 1 Low risk ( IEC 62471 )</b>
LED brand	<b>Bridgelux</b>
Service lifetime	<b>L80 / B20 - 50.000 h.</b>
Light temperature	<b>4000 K</b>
CRI	<b>CRI &gt;90</b>
SDCM	<b>&lt; 3</b>

### DRIVER CHARACTERISTICS

driver **DALI**

### LIGHTING DETAILS

emission	<b>rotationally symmetrical</b>
luminous effect	<b>flood</b>
optic	<b>40°</b>
Beam angle - direct	<b>40°</b>

### PHOTOMETRIC

