

Led Panel Smart

INC1231CA - 60 x 60 cm. - 50 W - 3000 K / 3000 K / CRI > 80

DESCRIPTION

The Led Panel Smart line is offered in a wide range of versions, in terms of output, colour temperatures and power supplies. All versions are characterized by enhanced luminous emission control to ensure maximum visual comfort, with a UGR value < 19 and the complete absence of flicker.

Switch

Casambi

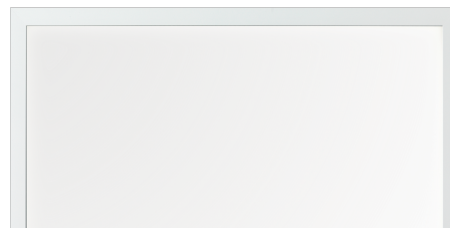

PRODUCTS CHARACTERISTICS

installation type	Light Panels
material	Extruded aluminum
Color	White
Power	50 W
Lumen output - Full emission	4700 lm
Efficacy	94 lm/W
Dimensions	60 x 60 cm.
net weight	2,7 kg.

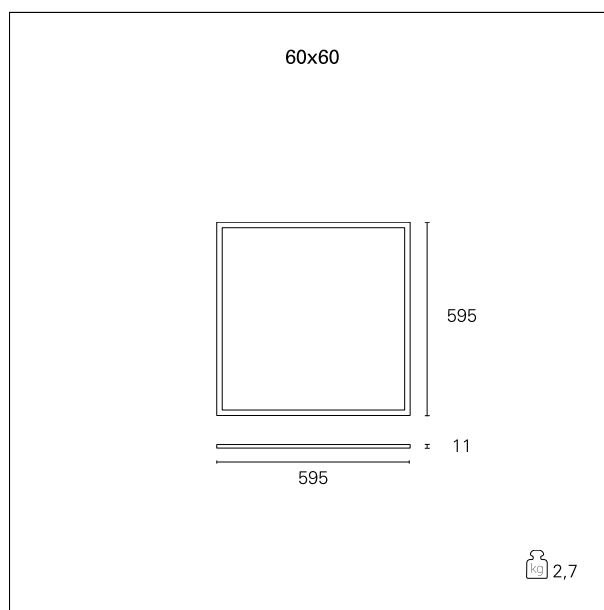

ELECTRICAL CHARACTERISTICS

feeding	220÷240 V
driver	Casambi
Insulation class	Class II

MECHANICAL CHARACTERISTICS

product IP rate	IP40
IK	IK03

Led Panel Smart

INC1231CA - 60 x 60 cm. - 50 W - 3000 K / 3000 K / CRI > 80

LED SOURCE DETAILS

led source type	SMD Led
Photobiological risk	RG 0 Exempt (IEC 62471)
Service lifetime	L80 / B20 - 50.000 h.
Light temperature	3000 K
CRI	CRI > 80

DRIVER CHARACTERISTICS

driver	Casambi
--------	----------------

LIGHTING DETAILS

Beam angle - direct	120°
UGR	≤ 19

PHOTOMETRIC

