

### Penny

GRF1011DM - ø 60 cm. - 60 W - 3900 lm / 3000 K / CRI > 80

#### DESCRIPTION

Penny is made of matt white painted aluminium and is characterized by its large PMMA lower screen which lights up perfectly evenly; Penny is suspended by means of four PVC-coated steel cables adjustable in height by means of four "grip locks" mounted on the canopy. By using Penny, soft and diffused downward light effects are obtained with emissions beyond 12000 lumens in the larger diameter version; Penny is therefore particularly suitable for illuminating large rooms with uniform light, perfectly distributed and without harsh shadows. Equipped with high efficiency SMD LED sources, Penny is complete with drivers integrated in the body of the fixture and is available with On/Off control or dimmable multifunction 1...10 V, Push, DALI. Penny is available in different sizes and powers and is combined with the corresponding versions for ceiling mounting. Available in dimmable "wireless signal" Bluetooth versions for Pan Digital or Casambi mesh network.

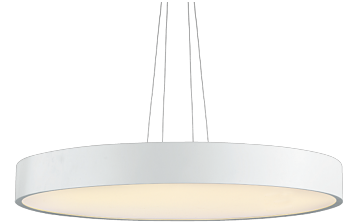

Switch 1...10 / Push / DALI

#### PRODUCTS CHARACTERISTICS

installation type	<b>High Bays</b>
material	<b>Aluminum</b>
Finish	<b>Painted</b>
Color	<b>White</b>
Power	<b>60 W</b>
Lumen output - Full emission	<b>3900 lm</b>
Diameter	<b>ø 60 cm.</b>
net weight	<b>3,8 kg.</b>

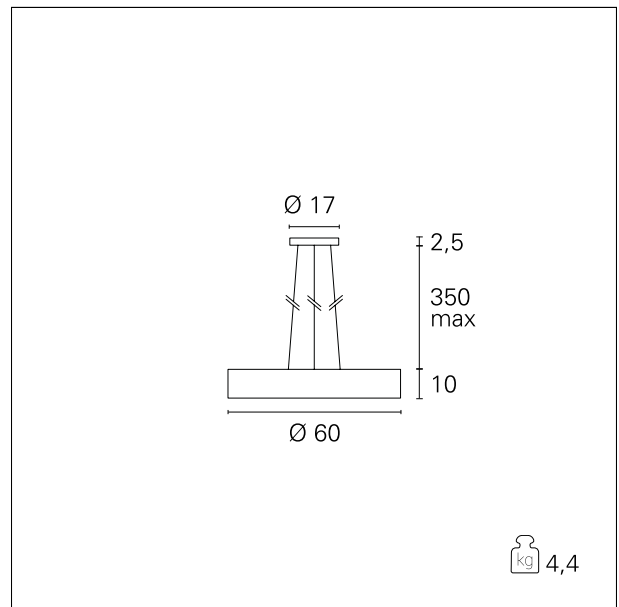

#### ELECTRICAL CHARACTERISTICS

feeding	<b>220÷240 V</b>
driver	<b>1...10 / Push / DALI</b>
Insulation class	<b>Class I</b>

## Penny

GRF10111DM - ø 60 cm. - 60 W - 3900 lm / 3000 K / CRI > 80

### MECHANICAL CHARACTERISTICS

product IP rate **IP20**

### LED SOURCE DETAILS

led source type **SMD Led**  
 Light temperature **3000 K**  
 CRI **CRI > 80**

### DRIVER CHARACTERISTICS

driver **1...10 / Push / DALI**

### LIGHTING DETAILS

emission **Downlight**  
 optic **110°**

### PHOTOMETRIC

