

Penny

GRF10111CA - ø 60 cm. - 60 W - 3900 lm / 3000 K / CRI > 80

DESCRIPTION

Penny is made of matt white painted aluminium and is characterized by its large PMMA lower screen which lights up perfectly evenly; Penny is suspended by means of four PVC-coated steel cables adjustable in height by means of four "grip locks" mounted on the canopy. By using Penny, soft and diffused downward light effects are obtained with emissions beyond 12000 lumens in the larger diameter version; Penny is therefore particularly suitable for illuminating large rooms with uniform light, perfectly distributed and without harsh shadows. Equipped with high efficiency SMD LED sources, Penny is complete with drivers integrated in the body of the fixture and is available with On/Off control or dimmable multifunction 1...10 V, Push, DALI. Penny is available in different sizes and powers and is combined with the corresponding versions for ceiling mounting. Available in dimmable "wireless signal" Bluetooth versions for Pan Digital or Casambi mesh network.

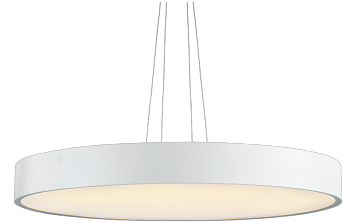

Switch

Casambi

PRODUCTS CHARACTERISTICS

installation type
material
Finish
Color
Power
Lumen output - Full emission
Diameter
net weight

High Bays
Aluminum
Painted
White
60 W
3900 lm
ø 60 cm.
3,8 kg.

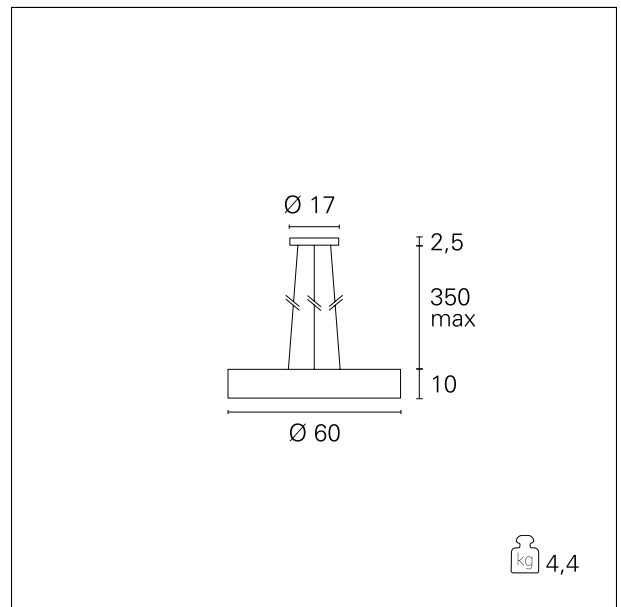

ELECTRICAL CHARACTERISTICS

feeding
driver
Insulation class

220÷240 V
Casambi
Class I

Penny

GRF10111CA - \varnothing 60 cm. - 60 W - 3900 lm / 3000 K / CRI > 80

MECHANICAL CHARACTERISTICS

product IP rate **IP20**

LED SOURCE DETAILS

led source type **SMD Led**
 Light temperature **3000 K**
 CRI **CRI > 80**

DRIVER CHARACTERISTICS

driver **Casambi**

LIGHTING DETAILS

emission **Downlight**
 optic **110°**

PHOTOMETRIC

