

Bike

GRF09211 - ø 80 cm. - 80 W - 4800 lm / 3000 K / CRI > 80

DESCRIPTION

Bike is made of matt white painted aluminium and is complete with lower PMMA screen; the pendant version is installed by means of three steel cables covered with transparent sheath and adjustable in height thanks to the three "grip locks" positioned on the body of the appliance. Bike allows you to create soft and diffused down light effects and is particularly suitable for general lighting of medium or large indoor ambients. The high efficiency SMD LED source is powered by the driver integrated in the fixture which can be On/Off or dimmable multifunction 1... 10V, Push, DALI controlled. Bike is available in different sizes and powers and can be combined with the corresponding versions for ceiling mounting. Available in dimmable "wireless signal" Bluetooth versions for Pan Digital or Casambi mesh network.

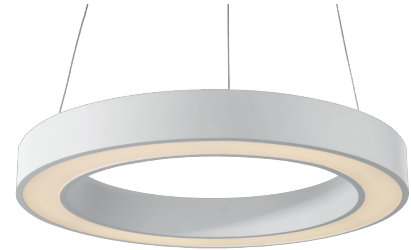

Switch **On÷Off**

PRODUCTS CHARACTERISTICS

installation type	High Bays
material	Aluminum
Finish	Painted
Color	White
Power	80 W
Lumen output - Full emission	4800 lm
Diameter	ø 80 cm.
net weight	6,4 kg.

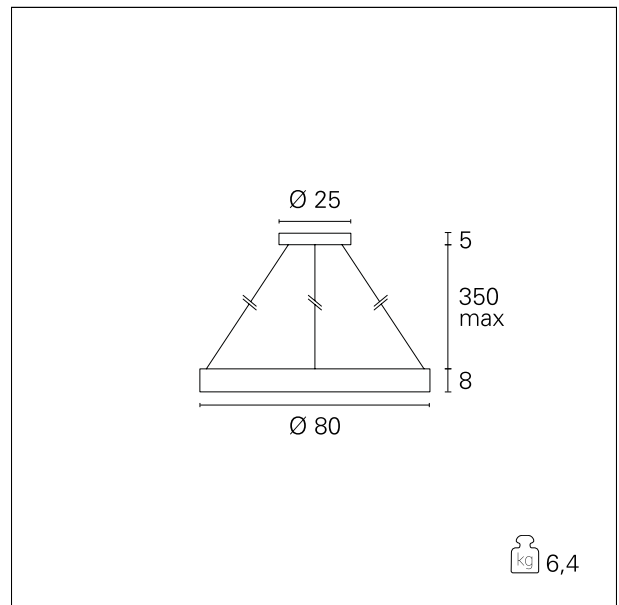

ELECTRICAL CHARACTERISTICS

feeding	220÷240 V
driver	On÷Off
Insulation class	Class I

MECHANICAL CHARACTERISTICS

Bike

GRF09211 - ø 80 cm. - 80 W - 4800 lm / 3000 K / CRI > 80

product IP rate **IP20**

LED SOURCE DETAILS

led source type **SMD Led**
 Light temperature **3000 K**
 CRI **CRI > 80**

DRIVER CHARACTERISTICS

driver **On+Off**

LIGHTING DETAILS

emission **Downlight**
 optic **100°**

PHOTOMETRIC

