

Bike

GRF09111DM - ø 50 cm. - 38 W - 2280 lm / 3000 K / CRI > 80

DESCRIPTION

Bike is made of matt white painted aluminium and is complete with lower PMMA screen; the pendant version is installed by means of three steel cables covered with transparent sheath and adjustable in height thanks to the three "grip locks" positioned on the body of the appliance. Bike allows you to create soft and diffused down light effects and is particularly suitable for general lighting of medium or large indoor ambients. The high efficiency SMD LED source is powered by the driver integrated in the fixture which can be On/Off or dimmable multifunction 1... 10V, Push, DALI controlled. Bike is available in different sizes and powers and can be combined with the corresponding versions for ceiling mounting. Available in dimmable "wireless signal" Bluetooth versions for Pan Digital or Casambi mesh network.

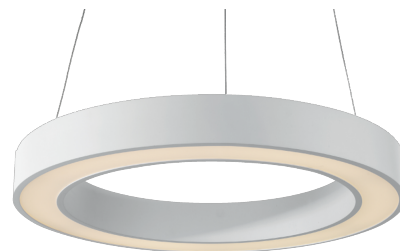

Switch 1...10 / Push / DALI

PRODUCTS CHARACTERISTICS

| | |
|------------------------------|------------------|
| installation type | High Bays |
| material | Aluminum |
| Finish | Painted |
| Color | White |
| Power | 38 W |
| Lumen output - Full emission | 2280 lm |
| Diameter | ø 50 cm. |
| net weight | 3,5 kg. |

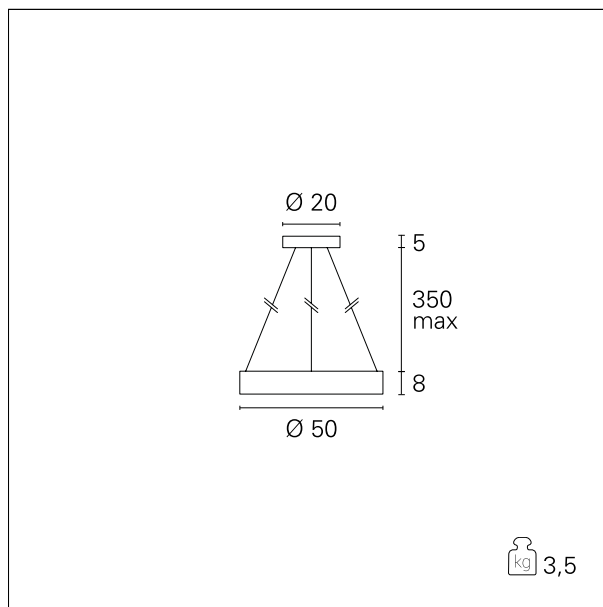

ELECTRICAL CHARACTERISTICS

| | |
|------------------|-----------------------------|
| feeding | 220÷240 V |
| driver | 1...10 / Push / DALI |
| Insulation class | Class I |

MECHANICAL CHARACTERISTICS

Bike

GRF09111DM - ø 50 cm. - 38 W - 2280 lm / 3000 K / CRI > 80

product IP rate **IP20**

LED SOURCE DETAILS

led source type **SMD Led**
 Light temperature **3000 K**
 CRI **CRI > 80**

DRIVER CHARACTERISTICS

driver **1...10 / Push / DALI**

LIGHTING DETAILS

emission **Downlight**
 optic **100°**

PHOTOMETRIC

