

### Corona

GRF07311CA - ø 81 cm. - 80 W - 4800 lm / 3000 K / CRI > 80

#### DESCRIPTION

Corona is made of matt white painted aluminium and is equipped with a diffusing screen in PMMA for soft and diffused light effects. The curvature of the aluminium body perfectly matches the curvature of the internal PMMA screen and creates a unique shape with a soft and contemporary design. Corona is installed in suspension by means of three steel cables covered with transparent sheath and adjustable in height thanks to the three "grip locks" positioned on the body of the appliance. The high efficiency SMD LED source is powered by the driver integrated in the fixture and can be On/Off or dimmable multifunction with 1... 10V, Push, DALI control. Corona is available in different sizes and powers and is combined with versions for ceiling installation. Available in dimmable "wireless signal" Bluetooth versions for Pan Digital or Casambi mesh network.



Switch

Casambi

#### PRODUCTS CHARACTERISTICS

installation type  
material  
Finish  
Color  
Power  
Lumen output - Full emission  
Diameter  
net weight

**High Bays**  
**Aluminum**  
**Painted**  
**White**  
**80 W**  
**4800 lm**  
**ø 81 cm.**  
**4,7 kg.**

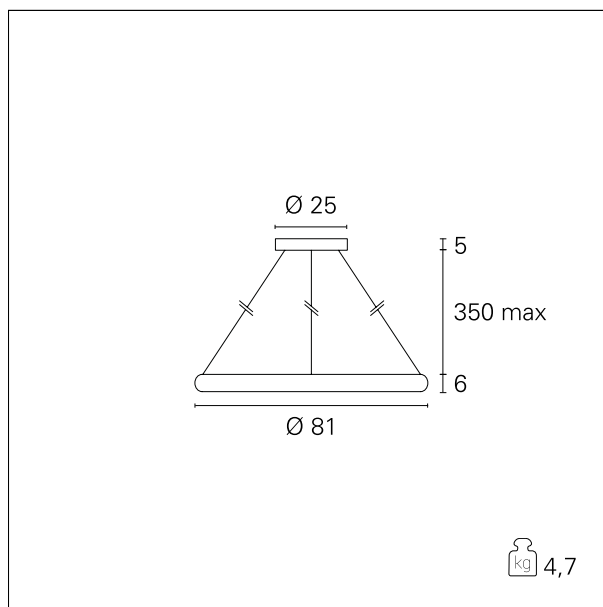

#### ELECTRICAL CHARACTERISTICS

feeding  
driver  
Insulation class

**220÷240 V**  
**Casambi**  
**Class I**

## Corona

**GRF07311CA** -  $\varnothing$  81 cm. - 80 W - 4800 lm / 3000 K / CRI > 80

### MECHANICAL CHARACTERISTICS

product IP rate **IP20**

### LED SOURCE DETAILS

led source type **SMD Led**  
 Light temperature **3000 K**  
 CRI **CRI > 80**

### DRIVER CHARACTERISTICS

driver **Casambi**

### LIGHTING DETAILS

emission **Downlight**  
 optic **160°**

### PHOTOMETRIC

