

### Egon

**GLT14310DA** - Rounded - 29 W - 2650 lumen / 3000 K / CRI >80

#### DESCRIPTION

Equipped with first brand SMD LEDs and with a diffusing screen, Egon recessed are the ideal solution for obtaining soft and diffused light effects. Thanks to a complete range and IP54 protection degree, Egon recessed luminaires are suitable for general lighting of all types of environments. The series of rings for the retrofit makes them particularly suitable for the replacement of traditional downlights with compact fluorescent lamps. 3 years warranty; lifetime L80-B20 / 50.000 h.



Switch

**DALI**

#### PRODUCTS CHARACTERISTICS

installation type	<b>Recessed Spotlights</b>
material	<b>Aluminum</b>
Color	<b>White</b>
Power	<b>29 W</b>
Lumen output - Full emission	<b>2619 lm</b>
Efficacy	<b>90 lm/W</b>
Diameter	<b>Ø 230 mm.</b>
net weight	<b>1,25 kg.</b>

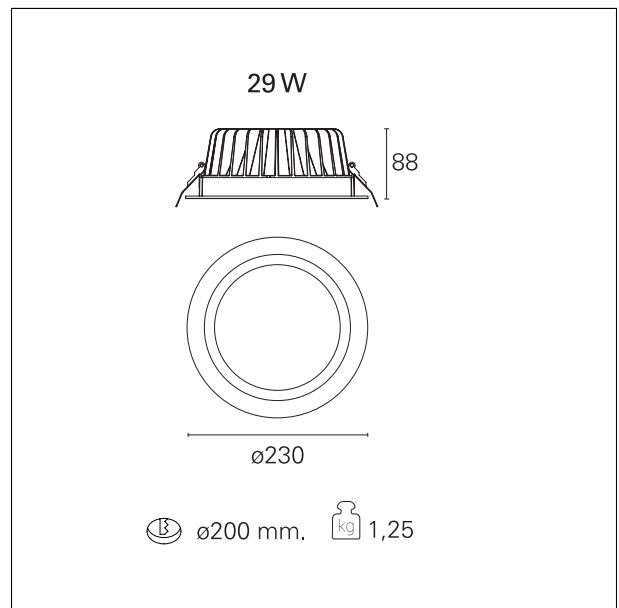

#### ELECTRICAL CHARACTERISTICS

feeding	<b>220÷240 V</b>
driver	<b>DALI</b>
Insulation class	<b>Class II</b>

#### MECHANICAL CHARACTERISTICS

optical compartment IP rate	<b>IP54</b>
recessed compartment IP rate	<b>IP20</b>

### Egon

**GLT14310DA** - Rounded - 29 W - 2650 lumen / 3000 K / CRI >80

#### HOLE RECESS DIMENSIONS

hole recess diameter **ø 200 mm.**

#### LED SOURCE DETAILS

led source type	<b>LED SMD</b>
Photobiological risk	<b>RG 1 Low risk ( IEC 62471 )</b>
LED current	<b>700 mA</b>
LED voltage	<b>40 V</b>
Service lifetime	<b>L80 / B20 - 50.000 h.</b>
Light temperature	<b>3000 K</b>
CRI	<b>CRI &gt;80</b>
SDCM	<b>&lt; 3</b>

#### DRIVER CHARACTERISTICS

driver	<b>DALI</b>
Power factor	<b>&gt; 0,9</b>
Operating temperature	<b>-20°C ÷ 45°C</b>

#### LIGHTING DETAILS

emission	<b>rotationally symmetrical</b>
luminous effect	<b>wide</b>
optic	<b>90°</b>
Beam angle - direct	<b>90°</b>
UGR	<b>&lt; 22</b>

#### PHOTOMETRIC

### Egon

GLT14310DA - Rounded - 29 W - 2650 lumen / 3000 K / CRI >80

