

Egon

GLT14210PD - Rounded - 23 W - 2200 lumen / 3000 K / CRI >80

DESCRIPTION

Equipped with first brand SMD LEDs and with a diffusing screen, Egon recessed are the ideal solution for obtaining soft and diffused light effects. Thanks to a complete range and IP54 protection degree, Egon recessed luminaires are suitable for general lighting of all types of environments. The series of rings for the retrofit makes them particularly suitable for the replacement of traditional downlights with compact fluorescent lamps. 3 years warranty; lifetime L80-B20 / 50.000 h.



Switch

Pan Digital

PRODUCTS CHARACTERISTICS

installation type	Recessed Spotlights
material	Aluminum
Color	White
Power	23 W
Lumen output - Full emission	2170 lm
Efficacy	94 lm/W
Diameter	Ø 193 mm.
net weight	0,90 kg.

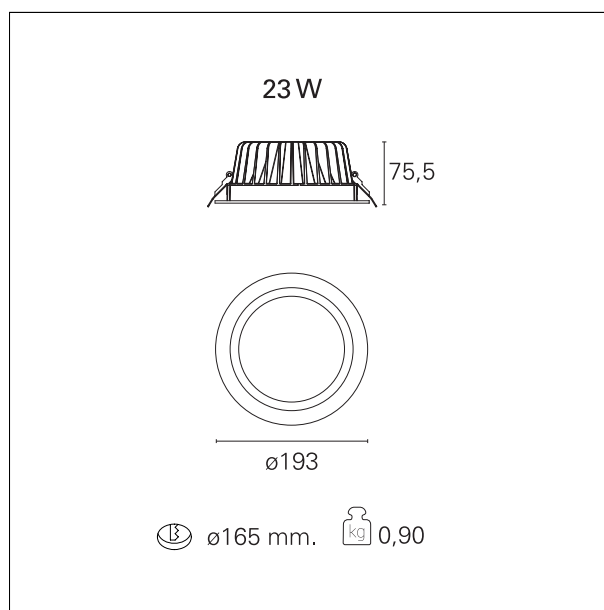

ELECTRICAL CHARACTERISTICS

feeding	220÷240 V
driver	Pan Digital
Insulation class	Class II

MECHANICAL CHARACTERISTICS

optical compartment IP rate	IP54
recessed compartment IP rate	IP20

Egon

GLT14210PD - Rounded - 23 W - 2200 lumen / 3000 K / CRI >80

HOLE RECESS DIMENSIONS

hole recess diameter **ø 165 mm.**

LED SOURCE DETAILS

led source type	LED SMD
Photobiological risk	RG 0 Exempt (IEC 62471)
LED current	350 mA
LED voltage	60 V
Service lifetime	L80 / B20 - 50.000 h.
Light temperature	3000 K
CRI	CRI >80
SDCM	< 3

DRIVER CHARACTERISTICS

driver	Pan Digital
Power factor	> 0,9
Operating temperature	-20°C ÷ 45°C

LIGHTING DETAILS

emission	rotationally symmetrical
luminous effect	wide
optic	90°
Beam angle - direct	90°
UGR	< 22

PHOTOMETRIC

Egon

GLT14210PD - Rounded - 23 W - 2200 lumen / 3000 K / CRI >80

