

### Egon

**GLT14120** - Rounded - 15 W - 1400 lumen / 4000 K / CRI >80

#### DESCRIPTION

Equipped with first brand SMD LEDs and with a diffusing screen, Egon recessed are the ideal solution for obtaining soft and diffused light effects. Thanks to a complete range and IP54 protection degree, Egon recessed luminaires are suitable for general lighting of all types of environments. The series of rings for the retrofit makes them particularly suitable for the replacement of traditional downlights with compact fluorescent lamps. 3 years warranty; lifetime L80-B20 / 50.000 h.



Switch

On+Off

#### PRODUCTS CHARACTERISTICS

installation type	<b>Recessed Spotlights</b>
material	<b>Aluminum</b>
Color	<b>White</b>
Power	<b>15 W</b>
Lumen output - Full emission	<b>1410 lm</b>
Efficacy	<b>94 lm/W</b>
Diameter	<b>Ø 162 mm.</b>
net weight	<b>0,65 kg.</b>

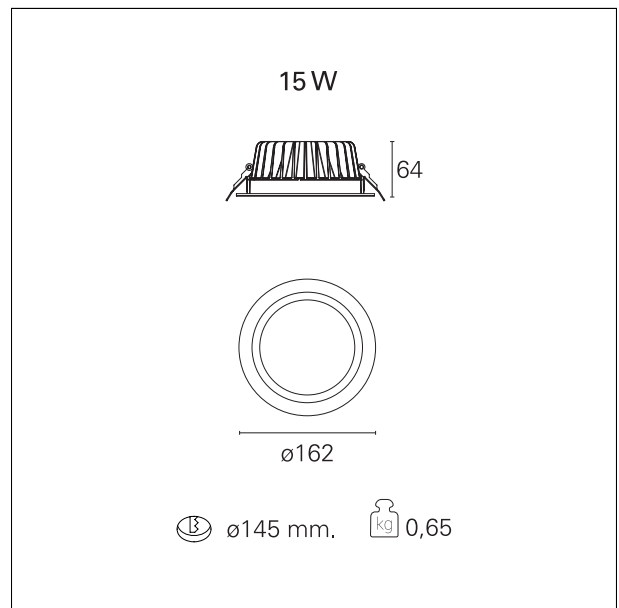

#### ELECTRICAL CHARACTERISTICS

feeding	<b>220÷240 V</b>
driver	<b>On+Off</b>
Insulation class	<b>Class II</b>

#### MECHANICAL CHARACTERISTICS

optical compartment IP rate	<b>IP54</b>
recessed compartment IP rate	<b>IP20</b>

### Egon

**GLT14120** - Rounded - 15 W - 1400 lumen / 4000 K / CRI >80

#### HOLE RECESS DIMENSIONS

hole recess diameter **ø 145 mm.**

#### LED SOURCE DETAILS

led source type	<b>LED SMD</b>
Photobiological risk	<b>RG 0 Exempt ( IEC 62471 )</b>
LED current	<b>350 mA</b>
LED voltage	<b>40 V</b>
Service lifetime	<b>L80 / B20 - 50.000 h.</b>
Light temperature	<b>4000 K</b>
CRI	<b>CRI &gt;80</b>
SDCM	<b>&lt; 3</b>

#### DRIVER CHARACTERISTICS

driver	<b>On÷Off</b>
Power factor	<b>&gt; 0,9</b>
Operating temperature	<b>-20°C ÷ 45°C</b>

#### LIGHTING DETAILS

emission	<b>rotationally symmetrical</b>
luminous effect	<b>wide</b>
optic	<b>90°</b>
Beam angle - direct	<b>90°</b>
UGR	<b>&lt; 22</b>

#### PHOTOMETRIC

### Egon

GLT14120 - Rounded - 15 W - 1400 lumen / 4000 K / CRI >80

