

Egon

GLT14110CA - Rounded - 15 W - 1400 lumen / 3000 K / CRI >80

DESCRIPTION

Equipped with first brand SMD LEDs and with a diffusing screen, Egon recessed are the ideal solution for obtaining soft and diffused light effects. Thanks to a complete range and IP54 protection degree, Egon recessed luminaires are suitable for general lighting of all types of environments. The series of rings for the retrofit makes them particularly suitable for the replacement of traditional downlights with compact fluorescent lamps. 3 years warranty; lifetime L80-B20 / 50.000 h.



Switch

Casambi

PRODUCTS CHARACTERISTICS

installation type	Recessed Spotlights
material	Aluminum
Color	White
Power	15 W
Lumen output - Full emission	1349 lm
Efficacy	90 lm/W
Diameter	Ø 162 mm.
net weight	0,65 kg.

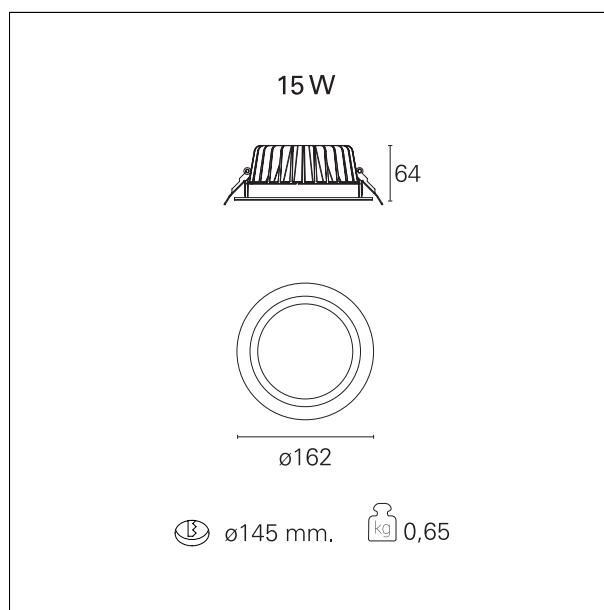

ELECTRICAL CHARACTERISTICS

feeding	220÷240 V
driver	Casambi
Insulation class	Class II

MECHANICAL CHARACTERISTICS

optical compartment IP rate	IP54
recessed compartment IP rate	IP20

Egon

GLT14110CA - Rounded - 15 W - 1400 lumen / 3000 K / CRI >80

HOLE RECESS DIMENSIONS

hole recess diameter **ø 145 mm.**

LED SOURCE DETAILS

led source type	LED SMD
Photobiological risk	RG 0 Exempt (IEC 62471)
LED current	350 mA
LED voltage	40 V
Service lifetime	L80 / B20 - 50.000 h.
Light temperature	3000 K
CRI	CRI >80
SDCM	< 3

DRIVER CHARACTERISTICS

driver	Casambi
Power factor	> 0,9
Operating temperature	-20°C ÷ 45°C

LIGHTING DETAILS

emission	rotationally symmetrical
luminous effect	wide
optic	90°
Beam angle - direct	90°
UGR	< 22

PHOTOMETRIC

Egon

GLT14110CA - Rounded - 15 W - 1400 lumen / 3000 K / CRI >80

