

Miniled

EST58105 - 1 W - Rounded / 3000 K / CRI >80

DESCRIPTION

Miniled is a floor and wall recessed product 1W/ 350 mA; IP67 rating. Aluminium body with front ring in AISI 316 steel, round or square (also available in matt white). Transparent protection glass. 3 optics available. Equipped with PBT housing. Driver not included.



PRODUCTS CHARACTERISTICS

installation type	Small Ingrounds
material	Aluminum / AISI 304 stainless steel
Color	Steel
Power	1 W
Lumen output - Full emission	110 lm
Efficacy	110 lm/W
Diameter	Ø 27 mm.
net weight	0,06 kg.

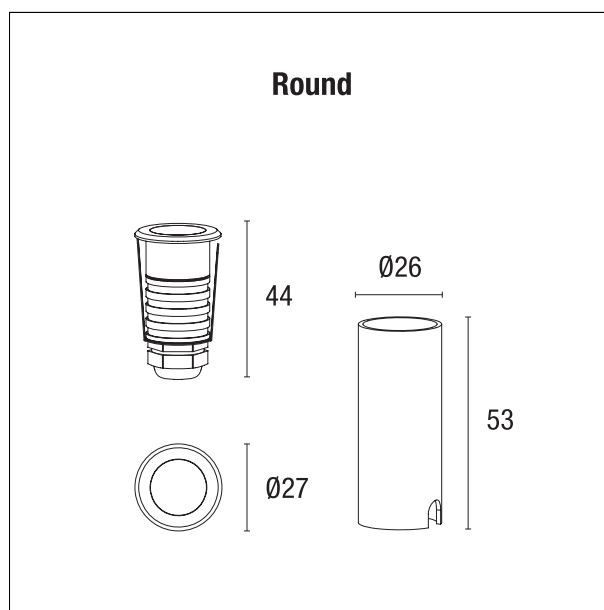

ELECTRICAL CHARACTERISTICS

feeding	350 mA CC
Insulation class	Class III

MECHANICAL CHARACTERISTICS

product IP rate	IP67
-----------------	-------------

Miniled

EST58105 - 1 W - Rounded / 3000 K / CRI >80

HOLE RECESS DIMENSIONS

hole recess diameter **ø 23 mm.**

LED SOURCE DETAILS

led source type	Power Led
LED current	350 mA
Light temperature	3000 K
CRI	CRI >80

LIGHTING DETAILS

emission	Direct
luminous effect	Projected
optic	30°

PHOTOMETRIC

