

Bart CoB

EST54211 - 18 W / 3000 K / CRI >80

DESCRIPTION

Recessed fixtures are primary elements in contemporary lighting design choices for creating highlights and dramatic lighting effects. In this product line, you'll find our best-selling items in the outdoor recessed program. The selection covers various light outputs, dimensions, LED types, optics, and adjustability. The fixture consists of a die-cast aluminum structure in which drivers, optics, and LED components are housed. Great care is taken in selecting the quality of die-casting, painting, and additional components. All models have a ring made of stainless steel AISI 316L, which, combined with specifically designed gaskets, provides the necessary sealing guarantees for every installation. Our offering is structured into two sections: CoB and Power LED.

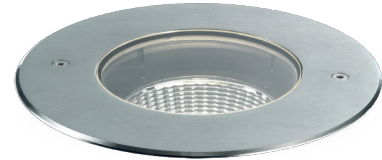

PRODUCTS CHARACTERISTICS

installation type	Small Ingrounds
material	AISI 316L stainless steel
Color	Steel
Power	18 W
Lumen output - Full emission	1530 lm
Efficacy	102 lm/W
net weight	2,8 kg.

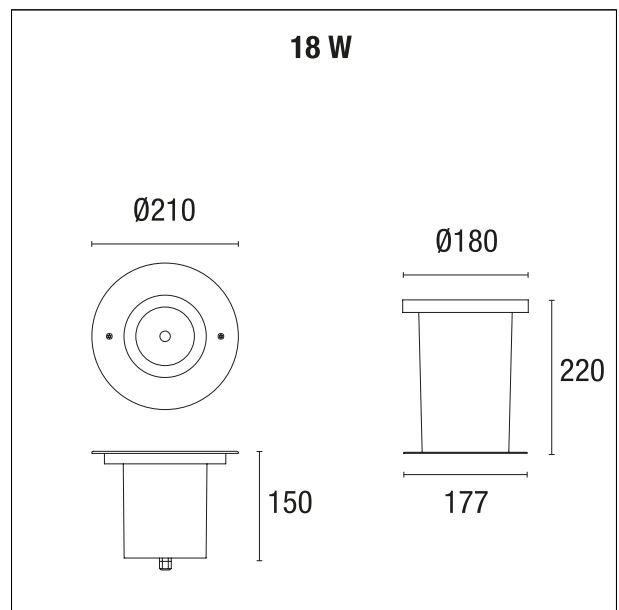

ELECTRICAL CHARACTERISTICS

feeding	220÷240 V
driver	On÷Off
Insulation class	Class I

MECHANICAL CHARACTERISTICS

product IP rate	IP67
IK	IK10

Bart CoB

EST54211 - 18 W / 3000 K / CRI >80

LED SOURCE DETAILS

led source type	CoB Led
Service lifetime	L80 / B20 - 50.000 h.
Light temperature	3000 K
CRI	CRI >80

LIGHTING DETAILS

emission	Indirect
optic	38°

PHOTOMETRIC

