

LIGHTING_ EVOLUTION

IN DOOR

Alter Alyson Asia & Asia Mini Backlit Backlit UGR Bahia Beam Berlin
Bike_Ceiling Bike_Pendants Bobby Boreale Bow Cama CoB Evo_Striped CoB
Line_Striped Color Quality_Striped Controllers and Drivers Corona_Ceiling
Corona_Pendants Cross Dama Day Dippy Eclis Egon Eli Elle Emergency
Kit Extreme_Ceiling/Wall Extreme_Track Extreme_ Recessed Fast Focus
Glove Grace GU10_ Recessed High Efficiency_Striped Hoop_Ceiling Hoop_
Pendants Idra Infinity Jango Jazz Joy Karma_Ceiling Karma_Pendant Karma_
Recessed Karma_Wall Kart_Ceiling Kart_Pendants Led Panel Accessories Led
Panel High Protection IP65 Led Panel Microprismatic Led Panel Smart Led
Panel Tunable Light Line Waterproof_Striped Light Line_Striped London
Lunar_Pendants Lunar_Floor Lupin_Wall Lupin_Pendants Maiko Match Maya
Mini Ambient_Floor Maya Mini_Ceiling Maya Mini Office_Floor Maya
Mini_Pendant Maya_Ceiling Maya_Pendant Maya_Recessed Maya_Track
Maya_Wall Maya_Wall/Pendant Microled Mida Milla Mini_Striped Miniled
Moby Nemo Neon Flex_Striped Oberon Onda Pako Panel Box Paris Penny_
Ceiling Penny_ Pendants Pill Plaster_Recessed Plasterboard_Recessed Profiles
Play Pod Polka Puck Extra Quik Recessed Profiles Rex RGB+3000K_Striped
Indoor RGB+3000K_Striped Outdoor Saturno Seal Shade Show IP65
Sinergy_Track Sinergy_Recessed Ska_Ceiling/Wall Ska_Track Slim_Ceiling/
Wall Slim Classic_Track Slim Evo_Track Slim GU10_Track Slim GU10_Ceiling/
Wall Slim_Recessed Slim_Track Smart Soft_Table Soft_Wall Soft_Floor Sol
Stek_Pendants Summer Sunny Surface Mounted Profiles Track 4 Track 6 Tube
Tunable_Striped Urano_Ceiling Urano_Pendant Yab Young Zaira

PAN



OVERVIEW

004 Pan
Light evolution

018 Collections

048 Product index

054 Recessed

164 Light Panels

184 Track

218 Ceiling

266 Pendants

316

Wall

372

Table lamps

400

Floor lamps

422

Industrial

430

Profiles

468

Stripled

498

Controllers
and Drivers

525

Info

PAN_ LIGHTING EVOLUTION



FOR MORE THAN
WE HAVE BEEN
FIXTURES AND
FOR PROFESSIONALS



Da sempre focalizzata nel settore dell'illuminazione, PAN nasce nel 1987 e negli anni si fa conoscere ed apprezzare come player qualificato sui mercati nazionali ed internazionali. Un gruppo di lavoro appassionato e sensibile ha saputo valorizzare le esperienze del passato aggiornandone i contenuti tecnici ed estetici. I contenuti dei cataloghi, indoor ed outdoor, coprono le primarie necessità del settore lighting. Una proposta attenta al contemporaneo, spesso capace di anticipare le necessità di progettisti, architetti e specialisti del settore. Ricerca, innovazione, qualità, sistemi produttivi all'avanguardia, sostenibilità, ricorso a partnership qualificate, sono i cardini primari su cui poggiano le scelte aziendali.

PAN, which has always been focused on the lighting sector, was founded in 1987 and over the years has made itself known and appreciated as a qualified player on national and international markets. A passionate and sensitive work group has been able to enhance past experiences while updating their technical and aesthetic contents. The contents of the catalogues, indoor and outdoor, meet the primary needs of the lighting sector. A trendy product range which is often capable to anticipate the needs of designers, architects and specialists of the sector.

La sua struttura, attenta alla valorizzazione delle competenze, consente all'azienda di gestire e sfruttare al meglio le opportunità e le tecnologie in continua evoluzione. PAN è in grado di soddisfare buona parte della domanda in ambiente contract, residenziale ed impieghi squisitamente professionali. I criteri estetici contemporanei sono alla base delle attività e tendono a valorizzare studi formali e progettuali. L'azienda riconosce il settore lighting come elemento primario nella progettazione dell'ambiente, capace di incidere e qualificare la vita quotidiana.

Research, innovation, quality, advanced production systems, sustainability, use of qualified partnerships, are the primary cornerstones on which the company's choices are based. With the development of skills as one of the main objects, PAN succeeds in managing and profiting from the opportunities and technologies that are constantly evolving. The company is able to satisfy the most needs of contracts, residential and exquisitely professional applications. Contemporary aesthetic criteria are at the basis of the activities giving formal and design studies much importance. PAN considers the lighting sector as a primary element in the design of the environment, capable of influencing and qualifying our daily life.

PAN 30 YEARS IN PRODUCING LIGHTING AND SOLUTIONS FOR PROFESSIONAL LIGHTING.



Costantemente alla ricerca di soluzioni hi-tech PAN ha sviluppato sistemi di lavoro eccellenti che modificano i classici rapporti cliente - fornitore. Il cliente e le sue esigenze sono il punto centrale su cui l'azienda focalizza il suo lavoro, il progetto e la costruzione del prodotto. L'azienda lavora costantemente al fianco di tecnici e progettisti offrendo il suo know-how certo di poter offrire un valore aggiunto nel settore di competenza.

Constantly looking for hi-tech solutions, PAN has developed excellent working systems modifying the classic customer - supplier relationship. The customer and his needs are the central point on which the company focuses its work, the project and the construction of the product. PAN constantly works alongside technicians and designers, offering its know-how in the belief of granting added value in its field.

Visione_ La luce accompagna la vita di tutti noi e sempre più ne determina qualità e livello di benessere. Coerentemente con questa visione, Pan realizza apparecchi e soluzioni illuminotecniche in linea con le necessità della clientela.

Vision_ The light accompanies the life of all of us and increasingly determines the quality and level of well-being. Consistently with this vision, Pan realizes lighting equipment and professional lighting solutions with the aim of making possible the lighting ideas of its customers.

Valori_ Il cliente e l'utilizzatore finale sono il focus delle attività aziendali. Il nostro ufficio tecnico è il partner di riferimento per progettisti, professionisti del settore. Il nostro staff fornisce il supporto necessario, consigliando i prodotti più adatti al soddisfacimento delle vostre richieste.

Values_ Customer and end user are the focus in all our activities. Our technical department is the reference partner for the lighting sector for designers, technicians and professionals. Our staff will be able to provide the necessary support for the development of lighting projects for interiors and exteriors, recommending the most suitable international and Made in Italy product, offering everything you need to satisfy your requests.

Missione_ Con passione e determinazione ci proponiamo quale partner ideale per lo sviluppo e la realizzazione dei vostri progetti nel settore. Da sempre dedichiamo importanti risorse nella R&S e progettiamo e finalizziamo tutti i prodotti all'interno dell'azienda in stretta collaborazione con designer e professionisti.

Mission_ Our mission is to be a reliable Italian partner for the development and implementation of your lighting projects. PAN dedicates important research and development resources, designing all its products within the company and in close collaboration with designers and professionals.



VISION_
VALUES_
MISSION

PROMO BOX, CONFIGURATORS, RESERVED AREA



Le attività a supporto dell'area commerciale sono in costante e continua evoluzione. Il marketing dei prodotti è supportato da cataloghi e demo box per i modelli più rappresentativi. Le attività su web hanno avuto un grande sviluppo e rappresentano oggi il principale collegamento con la clientela. Configuratori grafici evoluti uniti a software dedicati ci consentono di gestire milioni di codifiche nella massima semplicità operativa.

The activities supporting the commercial area are constantly evolving. Product marketing is supported by catalogs and demo boxes for the most representative models. On Line activities have had a great development and represent today the main connection with our customers. Advanced graphic configurators combined with dedicated software allow us to manage millions of encodings in maximum operational simplicity.

L'area riservata cliente permette la verifica della disponibilità prodotto, l'invio dell'ordine e la tracciatura della spedizione.

The customer reserved area allows product availability checking, the sending of the order and the tracking of the shipment.

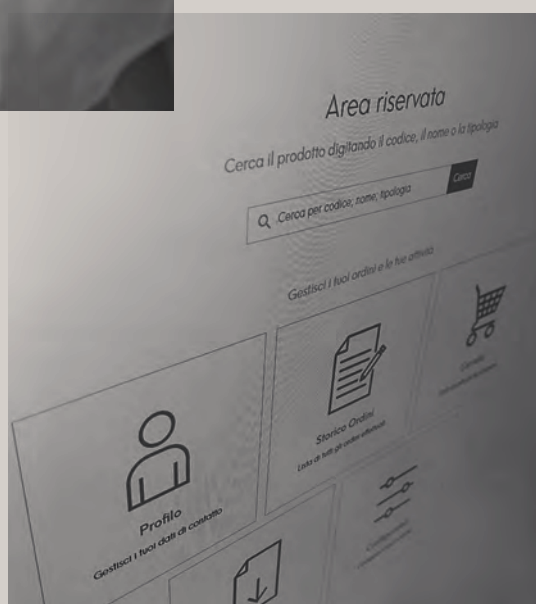

PAN_FACTORY

Riconosciamo il settore lighting come elemento primario nella progettazione dell'ambiente, capace di incidere e qualificare la nostra vita quotidiana. Costantemente alla ricerca di soluzioni hi-tech abbiamo sviluppato sistemi di lavoro eccellenti che modificano i classici rapporti cliente – fornitore. Il cliente e le sue esigenze sono il punto centrale su cui focalizziamo il nostro lavoro, il progetto e la costruzione del prodotto. Lavoriamo costantemente al fianco di tecnici e designers, certi di poter offrire un valore aggiunto nel settore di competenza.

We consider the lighting sector as a primary element in the design of the environment, capable of influencing and qualifying our daily life. Constantly looking for hi-tech solutions, we have developed excellent working systems modifying the classic customer – supplier relationship. The customer and his needs are the central point on which we focus our work, the project and the construction of the product. We constantly work alongside technicians and designers, offering our know-how in the belief of granting added value in our field.

1000_CUSTO
12500_ITEMS
54_COUNTRI
10000_MQ H

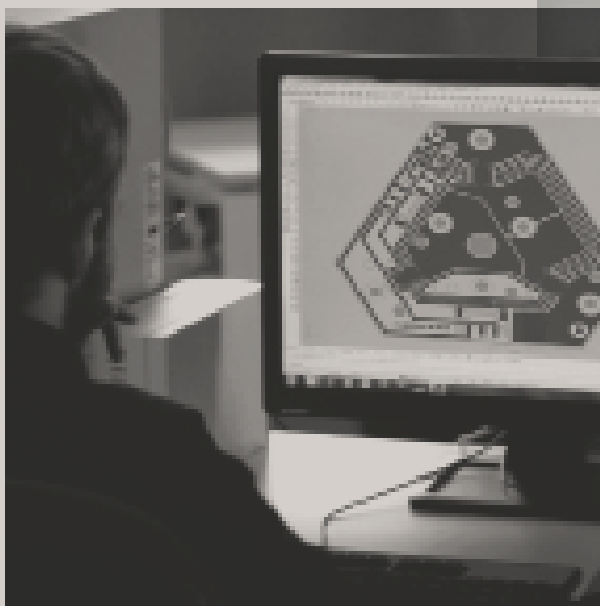

Ricerca, innovazione, qualità, sistemi produttivi all'avanguardia, sostenibilità, ricorso a partnership qualificate, sono i cardini su cui poggiano le scelte aziendali. La nostra struttura, attenta alla valorizzazione delle competenze, ci consente di gestire e sfruttare al meglio le opportunità e le tecnologie in continua evoluzione. Siamo in grado di soddisfare buona parte della domanda in ambiente contract, residenziale ed impieghi squisitamente professionali.

Research, innovation, quality, advanced production systems, sustainability, use of qualified partnerships, are the primary cornerstones on which our company choices are based. With the development of skills as one of our main objects, we succeed in managing and profiting from the opportunities and technologies that are constantly evolving. We are able to satisfy the most needs of contracts, residential and exquisitely professional applications.

CLIENTS, PRODUCTS IN THE CATALOG, MARKETS IN THE WORLD, HEADQUARTER AND WAREHOUSE

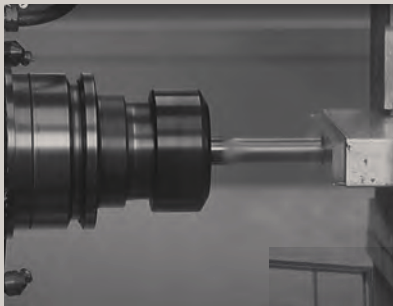

Lo sviluppo aziendale ha sempre tenuto in grande evidenza la crescita tecnologica. I reparti produttivi, di finitura e montaggio in cui sviluppiamo i nostri prodotti sono garanzia della perfetta funzionalità dei nostri apparecchi. Negli ultimi anni l'attenzione verso la meccanizzazione e la robotica ha avuto un ulteriore impulso e spinge l'azienda verso la crescita qualitativa ed il miglioramento dei processi produttivi.

The company's development has always highlighted technological growth. The production, finishing and assembly departments in which we develop our products guarantee the perfect functionality of our appliances. In recent years the focus on mechanization and robotics has had a further impulse and pushes the company towards qualitative growth and improvement of production processes.



**“SODDISFARE
I BISOGNI DELLA
GENERAZIONE PRESENTE
SENZA COMPROMETTERE
QUELLI DELLA
GENERAZIONE FUTURA”**

**"MEETING NEEDS OF PRESENT
GENERATION WITHOUT
COMPROMISING THOSE
OF THE FUTURE"**

corporate project

2021/
2025

Questa è la sintesi dei modelli che identificano lo sviluppo sostenibile. Il progetto aziendale 2021/2025 mette la sostenibilità tra i target primari da perseguire. Efficienza, tecnologia, digitalizzazione, integrazione e valorizzazione dei rapporti interpersonali sono gli elementi fondanti della nostra mission. Un quadro d'insieme che mira all'eccellenza nelle valutazioni legate al rispetto ambientale.

This is the synthesis of the models of sustainable development. The 2021/2025 corporate project puts sustainability among the primary targets to be pursued. Efficiency, technology, digitalization, integration and enhancement of interpersonal relationships are the founding elements of our mission. An overview that aims for excellence in environmental assessments.



Materials, Packaging, Photovoltaic

Selezione dei materiali e degli imballaggi, fonti energetiche rinnovabili, progettualità mirata al contenimento dei consumi rimangono centrali nelle scelte aziendali. L'ultimo investimento garantirà l'indipendenza energetica aziendale a partire dal settembre 2023. Un parco fotovoltaico da 200Kw è in realizzazione nei tetti del nostro stabilimento.

Selection of materials and packaging, renewable energy sources, reduction and containing of consumption remain central to the company's choices. The latest investment will guarantee corporate energy independence from September 2023. A 200kw photovoltaic park is being built on the roofs of our factory.



MAX COLOUR RENDERING

_Info_p.538

La classificazione CRI (dizione anglosassone Color Rendering Index) rappresenta un indice variabile su una scala 0 - 100 e sottintende la capacità di fedele restituzione del colore sull'oggetto illuminato. Fa riferimento ad una scala colore che prevede il campionamento di 8 colori Ra(8) cui sono stati aggiunti 6 toni Ra(14). Questa sintesi presenta limitazioni evidenti se utilizzato con le moderne sorgenti Led. Affinchè si apprezzino maggiormente le qualità cromatiche dell'illuminazione le metriche di misurazione tendono a cambiare ed evolversi. La codifica TM_30-15 utilizza un campionamento di 99 colori, derivati da elementi presenti in natura, ma soprattutto include valori legati all'analisi della saturazione sulla scena rappresentata. Si cerca di comporre un quadro quanto più fedele possibile nella restituzione dei colori percepiti. Un nuovo valido approccio utile alla sintesi progettuale che qualifica una sorgente luminosa e la rende più consona all'utilizzo preposto.

The Color Rendering Index (CRI) measures the ability of a light source to reproduce the colors of the object it illuminates. The CRI classification represents a variable index on a 0-100 scale. It refers to a color scale that provides the sampling of 8 Ra colors (8) to which were added an additional 6 tones (14). This approach has considerable limitations when used with modern Led technology. Several interpretations followed up to TM_30-15 sampling 99 colors. It derives from natural elements and includes analysis of saturation on the represented scene. The new standard tries to compose a picture as faithfully as possible in returning the perceived colors. A new valid approach useful to qualify a light source and makes it closer to the intended use.

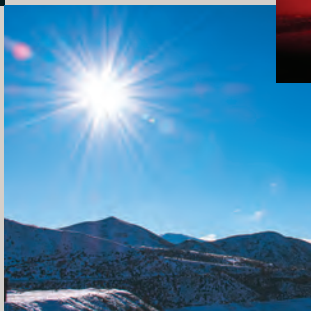
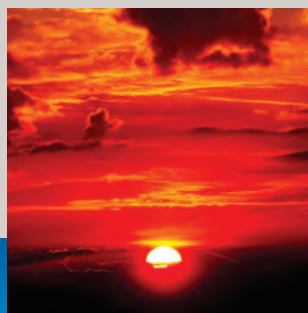

HUMAN CENTRIC LIGHTING

La luce accompagna la vita di tutti noi e ne determina la qualità ed il livello di benessere. La crescita tecnologica ha reso possibile la realizzazione di apparecchi di illuminazione adattabili alle diverse necessità. Elettronica e domotica permettono di gestire in modo semplice intensità, qualità e colore della luce emessa. L'utilizzo di software specifici consente quindi di riproporre l'illuminazione tipica dei ritmi naturali legati al benessere quotidiano e stagionale. Le soluzioni ed i sistemi di gestione che ottimizzano questi aspetti prendono il nome di Human Centric Lighting (HCL).

Light is our life and determines quality and level of well-being. Modern lighting devices can be adapted to different needs. Domotics and electronics make easy tuning and balancing of lighting systems. By changing the quality and color of the light, adapting the artificial lighting to the seasons and the time of the day, it is possible to reproduce the natural rhythms. The set of lighting solutions and systems are called Human Centric Lighting (HCL).

_Info_p.498



OPTICALS

_Info_p.526

La crescita tecnologica dell'ultimo decennio ha rivoluzionato il mondo dell'illuminazione. Elettronica e digitalizzazione hanno contribuito alla nascita di nuovi sistemi affidabili e prestazionali. Ricerca e sviluppo consentono di sfruttare al meglio queste risorse ed allargano l'offerta in ogni specifico settore. La nostra azienda, da sempre attenta all'innovazione, offre oggi un pacchetto di soluzioni vasto ed adattabile alle diverse tipologie applicative. Ottiche e riflettori dedicati giocano un ruolo di primo piano nelle scelte progettuali e nella corretta gestione dei flussi luminosi. Il catalogo 2023 sintetizza le nostre idee offrendo al mercato una gamma molto vasta di prodotti capaci di soddisfare il professionista e la committenza più esigente. I nostri apparecchi utilizzano ottiche di massima precisione, che garantiscono affidabilità ed alte prestazioni. La perfetta sincronia tra emitter ed ottica consente di sfruttare al meglio i potenziali di efficienza e qualità della luce. Le ottiche impiegate sui nostri apparecchi rispondono alle normative UNI EN 12464-1 per ambienti di lavoro nel rispetto dell'indice di abbagliamento richiesto. Un buon comfort visivo è elemento di primaria importanza nella progettazione illuminotecnica.

The technological growth of the last decade has changed the world of lighting. Electronics and digitalisation have contributed to new reliable systems with high performance. Research and development allow our customer to make the most of these resources and expand the offer in every sector. Our company, always careful to innovation, offers today a large and adaptable package of solutions to the different application types. Dedicated optics and reflectors play a leading role in the design choices and in the correct management of light flows. The 2023 catalogue summarizes our ideas offering to the market a wide range of products to satisfy the high standards of professionals and clients. Our devices use high precision optics, which guarantee reliability and high performance. The perfect synchrony between emitter and optics allows our customer to get the best potential in efficiency and quality of light. The optics used on our devices comply with UNI EN 12464-1 regulations for working environments in compliance with the required glare index. Good visual comfort is a key element in lighting design.

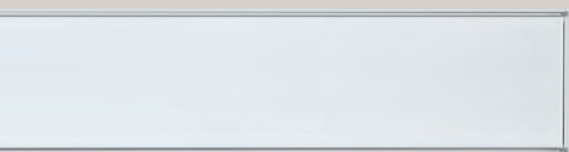

HOME SMART LIGHTING

_Info_p.504

TUYA supporta una vasta gamma di prodotti LED: RGB, RGB White, Tunable white o Monocromatico. La connessione Wi-Fi consente di gestire i dispositivi tramite l'app Tuya: accensione, spegnimento e regolazione dei punti luce. Si impostano scenari, programmi e scelta colore. È possibile creare automazioni, come accendere le luci al tramonto o creare un "dinner time" che regoli le luci a un'atmosfera più calda e soffusa. Inoltre, grazie all'integrazione con assistenti virtuali come Alexa e Google Assistant, è possibile controllare le luci Tuya tramite comandi vocali. L'interoperabilità consente di integrare le luci Tuya con altri dispositivi e creare una "Smart Home" personalizzata.

TUYA supports a wide range of LED products: RGB, RGB White, Tunable white or Monochrome. The Wi-Fi connection allows to manage devices via Tuya app: switch on - off, dimming. It's possible to set scenarios, programs and color choice. You can create automations and custom scenarios, such as turning on the lights at sunset or create a "dinner time" that regulates the lights to a warmer and suffused atmosphere. In addition, thanks to integration with virtual assistants such as Alexa and Google Assistant, you can control Tuya lights via voice commands. Interoperability allows you to integrate Tuya lights with other devices and create your "Smart Home".

Powered by



L'applicazione Tuya può essere utilizzata su smartphone o tablet e permette la gestione dei dispositivi "SMART" ovunque sia disponibile una connessione Internet. Con questa tecnologia si semplifica il controllo dei dispositivi d'illuminazione ad essa collegati. Il collegamento alla rete WI-FI consente accensioni, spegnimento, regolazioni sia nei locali dove si trovano gli apparecchi, sia da zone distanti.

Tuya application can be used on smartphones or tablets and allows the management of "SMART" devices wherever an Internet connection is available. This technology simplifies the control of connected lighting devices. WI-FI network allows ON-OFF switch, dimming and colour control in the rooms where the devices are located and from distant areas.



C O L O U R S

**BE DIFFERENT!
BE COOL!**



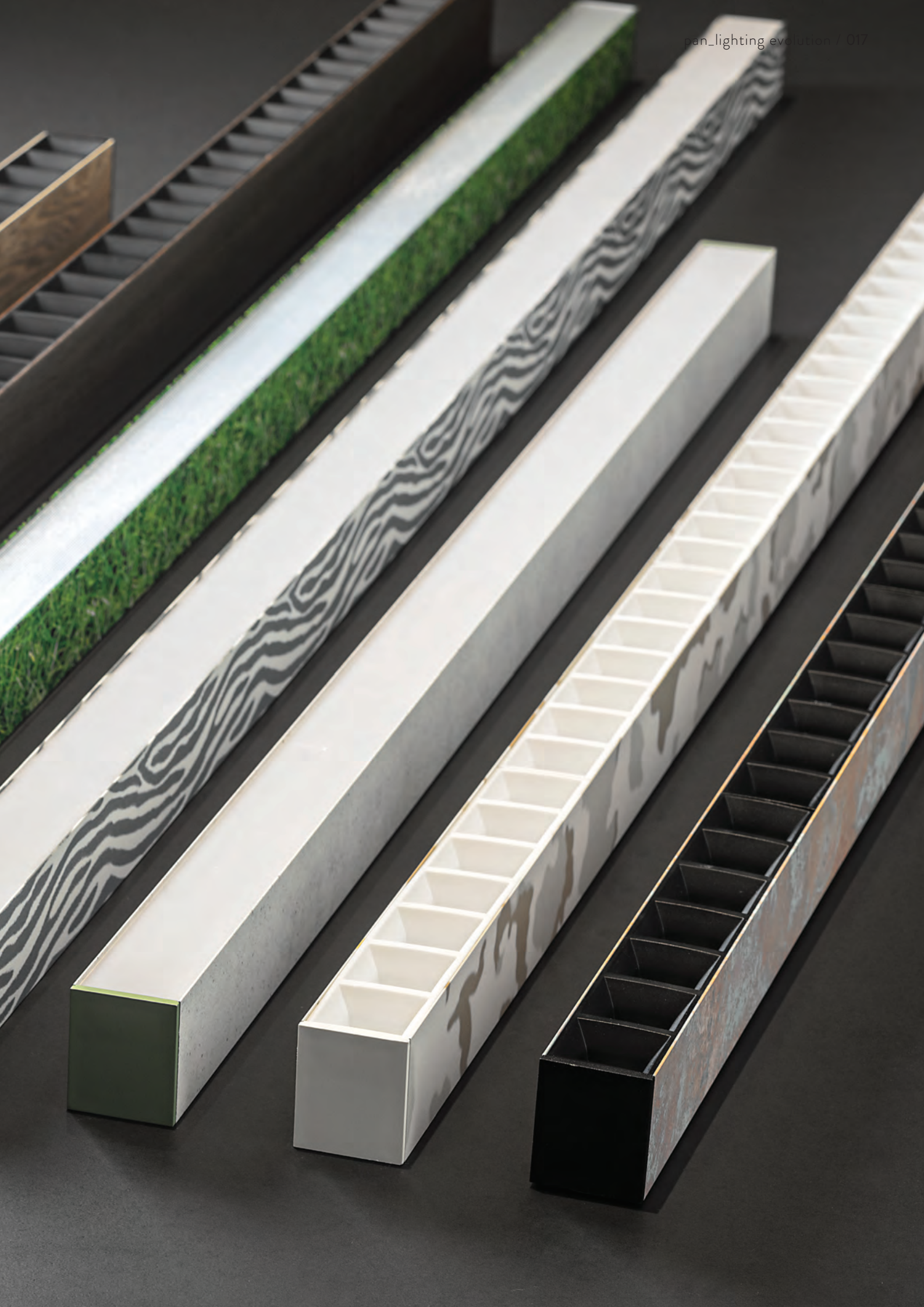

C O L L E C T I O N S

SLIM

SLIM si pone come modello centrale nella sezione proiettori. Sull'onda del successo commerciale raccolto presentiamo diversi aggiornamenti che rendono SLIM ancora più efficiente e versatile. Nel rispetto degli affermati equilibri estetici e tecnologici si rendono disponibili ulteriori applicazioni con il rilascio di SLIM EVO: driver separati e prestazionali per la gamma track, installazioni da soffitto, parete e semincasso; possibilità d'impiego di sorgenti GU10, nuovi colori aggiuntivi ai classici bianco e nero. SLIM, forte di componenti elettronici di primissimo piano, si conferma scelta vincente in tutte le installazioni professionali ove si richiede affidabilità, prestazioni ed efficienza.

SLIM is the central model in the headlamp section. In the wake of the commercial success we present several updates that make SLIM even more efficient and versatile. In accordance with the established aesthetic and technological balances, further applications are available with the release of SLIM EVO: separate drivers and performance for the track range, ceiling-wall installations, semi-recessed and possibility of use of GU10 sources, new colors additional to the classic black and white. SLIM, strong of electronic components of the highest level, confirms itself as a winning choice in all professional installations where reliability, performance and efficiency are required





C O L L E C T I O N S

Powers 12W, 20W, 33W**Colours White, Black, Silver, Sand, Tobacco****SLIM EVO_Dali_p.196**

Tre le potenze disponibili nella sezione SLIM EVO DALI: 12W, 20W, 33W. Un range di emissioni duttile e completo si associa alle diverse ottiche che rendono SLIM la soluzione ideale per impieghi retail, show room, museale. Una serie di driver affidabili e di riconosciuta semplicità d'installazione garantisce prestazioni di massimo livello.

Three powers available in the SLIM EVO DALI section: 12W, 20W, 33W. A ductile and complete emission range is combined with the different optics that make SLIM the ideal solution for retail, show room and museum applications. A series of reliable drivers with recognized easy of installation ensures maximum performance.

**SLIM_Gu10_p.198**

Il proiettore SLIM si adatta anche ad impieghi semplificati e "ready to use" con adattatore binario o versioni da parete - soffitto. A disposizione della clientela l'estetica SLIM con portalampade GU10 che permette la massima flessibilità d'uso con l'impiego delle diverse sorgenti luminose presenti sul mercato.

The SLIM projector is also suitable for simplified and "ready to use" applications: rail adapter or wall - ceiling versions. Available the SLIM aesthetic with GU10 lamp holder that allows maximum flexibility of use with different light sources on the market.

SLIM EVO_DALI_“Ghost”_p.197

La costante crescita tecnologica nella sezione alimentatori si utilizza per esaltare la pulizia formale del proiettore SLIM. Il driver DALI, di ridottissime dimensioni, scompare all'interno del binario non appena l'adattatore è fissato. Il componente elettronico che garantisce l'alimentazione diventa invisibile e permette di apprezzare la qualità estetica dell'apparecchio.

The technological growth in the power supply section is used to enhance the formal cleanliness of the SLIM projector. The very small DALI driver disappears into the rail as soon as the adapter is fixed. The electronic component that ensures the power supply becomes invisible and allows to appreciate the aesthetic quality of the device.



SLIM_Ceiling/Wall_p.248

Slim in versione parete – soffitto completa l'offerta e permette diversi utilizzi in associazione con la versione track e semi-incasso. Il driver è posizionato all'interno dell'apparecchio così da privilegiare forme contenute nel dimensionamento della base.

Slim wall - ceiling version completes our offer and allows different uses in association with the track and semi-recessed version. The driver is positioned inside the device in order to favor shapes contained in the sizing of the base.

COLLECTIONS

NEMO

Un programma completo ideale supporto per ogni necessità illuminotecnica. Retail, Show room, Residential, Hospitality, Office, General lighting: le nostre soluzioni risolvono brillantemente ogni impiego garantendo alti standard qualitativi. Efficienze elevate con emissioni da 500 a 3500 lm. Installazioni fisse, orientabili, con basso indice UGR, trimless, IP 54; ampio range di temperature di colore: 2700K - 3000K - 4000K, tunable white. Piani ottici differenziati secondo specifici utilizzi, scelte estetiche variabili per colori e modelli. Le principali gestioni elettroniche completano la proposta.

A full range of products ideal for every lighting need. Retail, Show room, Residential, Hospitality, Office, General lighting: Nemo range can offer high colour quality (CRI>92) and Prime brand LED. Emissions from 500 to 3500 lm. Fixed installations, adjustable, low UGR index, trimless, IP54. Wide range of colour temperatures: 2700K - 3000K - 4000K and tunable white. Different Optical planes according to specific uses, variable aesthetic choices thanks to a wide range of colors and models. The main electronic managements complete our proposal.



CONFIGURATOR





C O L L E C T I O N S

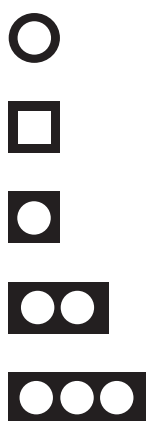

**UNA GAMMA COMPLETA,
TECNOLOGICAMENTE AVANZATA,
ADATTA AD OGNI NECESSITÀ
ILLUMINOTECNICA.**

**A COMPLETE TECHNOLOGICALLY
ADVANCED RANGE, SUITABLE FOR
ALL LIGHTING NEEDS**



Powers 6W, 10W,
15W, 24W, 33W, 42W
85.000 Codes

Ampia la gamma per aspetto estetico o tecnico. La sezione "RING" ha bordo a vista. "SIMPLE" ha un bordo rastremato e permette installazioni semplificate, quasi invisibili su cartongesso. L'effetto finale è molto simile alle soluzioni trimless. La serie "EYE" offre un elevato comfort visivo. Diverse le configurazioni per lampada GU10. Non mancano versioni con grado di protezione IP54.

Our Nemo offer has been extended and provide a complete lighting solution for designers and lighting specialist. "RING" range present the visible edge, "SIMPLE" have a simplified edge almost invisible on plasterboard installation. The final effect is very close to trimless solutions. The "EYE" offer high visual comfort. Also available GU10 models as well as IP54 versions.

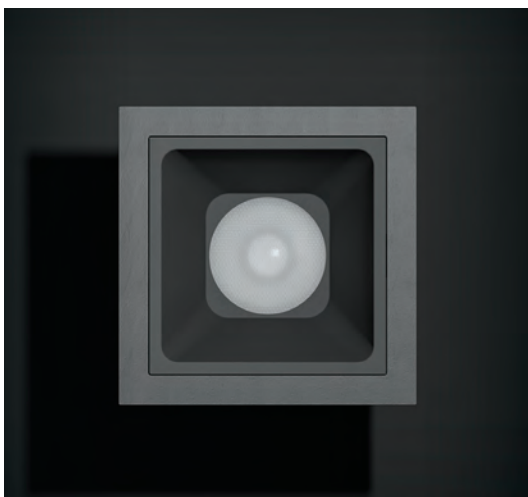

Il modello più apprezzato nella nostra gamma si fa preferire per la pulizia formale e per l'assoluta eleganza delle linee nette e definite. Si utilizza con riflettore COMFORT; è disponibile in tutte le potenze ed è impiegato nelle installazioni più qualificate.

The most popular model in our range is preferred for the absolute elegance and defined lines. The construction require COMFORT reflector and it is used in the most qualified installations.

C O L L E C T I O N S

KARMA

Karma è un sistema d'illuminazione che si pone ai vertici della categoria per qualità, efficienza ed estetica. La validità dei contenuti permette il passaggio dalla forma lineare alle composizioni, coniugando la tecnologia più avanzata ad un quadro stilistico contemporaneo e di facile interpretazione. Diverse le tipologie d'installazione: soffitto, parete, incasso trimless e sospensione. Karma è disponibile in diverse misure, con flussi emessi adattabili alle specifiche necessità applicative.

Karma is a top category lighting system which stands out for its quality, efficiency and aesthetics. The validity of the contents allows the passage from the linear form to compositions, combining the most advanced technology with a contemporary and easy to interpret stylistic framework. Different types of installation available: ceiling, wall, trimless downlight and suspension. Karma is available in different sizes with emitted flows which can meet any specific installation need.

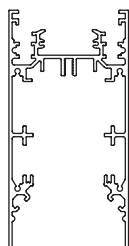

55x110mm





CONFIGURATOR



C O L L E C T I O N S

4 mountings / 3 emissions /
5 opticals / 4 powers / 5 controls /
4 colour temperatures /
5 structure colours

KARMA
Pendant_p.268



KARMA
Ceiling_p.220

Il sistema Karma offre caratteristiche e funzionalità che lo rendono unico nel suo genere. Ogni installazione (sospensione, parete, soffitto, incasso trimless) si può configurare come elemento singolo oppure come sistema. La trave centrale ospita il passaggio della linea elettrica primaria e le sezioni di alimentazione dei singoli moduli. Il vano ottico, in cui sono montate le schede e le ottiche secondarie, è separato dal profilo principale. Questa scelta progettuale garantisce qualità costruttiva ed il rispetto degli alti contenuti tecnici del sistema. Il progetto ha tenuto in grande considerazione la rapidità d'installazione e la funzionalità dell'accoppiamento tra i diversi elementi. L'installazione dei moduli in linea continua si realizza grazie ai particolari giunti meccanici "Junction Driven" che assicurano una miglior precisione nell'allineamento delle barre ed un cablaggio elettrico semplificato. Karma è disponibile in diverse misure, colori e gestioni elettroniche che prevedono ON-OFF, DALI, Push, Casambi, emergenza. Le numerose ottiche a disposizione sul sistema confermano la validità del progetto che mantiene inalterato il suo valore nel tempo.



KARMA
Wall_p.326

The Karma system offers features and functionalities that make it unique in its kind. Each installation (suspension, wall, ceiling, recessed) can be configured as a single element or as a system. The central beam accommodates the passage of the main power line and the power supply sections of the individual modules. The optical compartment, where the boards and secondary optics are mounted, is separated from the main profile. This design choice ensures construction quality and compliance with the system's high technical standards. The project has greatly considered the speed of installation and the functionality of the coupling between the different elements. The mechanical-electrical "fast junction" connection used in the system configuration guarantees the perfect alignment of the bars as well as the electrical continuity of the entire system. Karma is available in different sizes, colors and electronic management that include ON-OFF, DALI, Push, Casambi, emergency. The numerous optics available on the system confirm the validity of the project that keeps its value unchanged over time.



KARMA
Recessed_p.056

C O L L E C T I O N S

MAYA

Il modello Maya aggiorna e sintetizza, con dimensioni ridotte, le esperienze produttive maturate negli ultimi anni. Maya esprime design curato, efficienza tecnologica ed estetica. Il prodotto è realizzato con estruso in alluminio verniciato con polveri epossidiche. La gestione elettronica è affidata a componenti di primissimo livello in grado di garantire le migliori prestazioni per efficienza e stabilità nel tempo. Maya è disponibile in diverse applicazioni: sospensione, parete, soffitto, incassato. È coperta l'intera gamma di alimentazione: On/Off, Dali, Push, Casambi. Maya impiega schede Led ad alta efficienza nelle varianti 2700K, 3000K e 4000K nonché una versione tunable white.

The new Maya design summarizes the new productive experiences acquired in the last years. Small-sized it conveys optimal design, tech efficiency and esthetic appeal. The product is realized with aluminum extrusion painted in epoxy powder. The electronic unit is managed by first-tier component to guarantee the highest performance, efficiency and durability. Maya is available in several applications: pendant, wall, ceiling and recessed. Top level in electronic controls: On/Off, Dali, Push, Casambi. Maya has high efficiency LED circuit boards in 2700K, 3000K, 4000K and tunable white version.

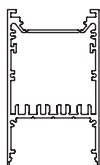

42x72mm

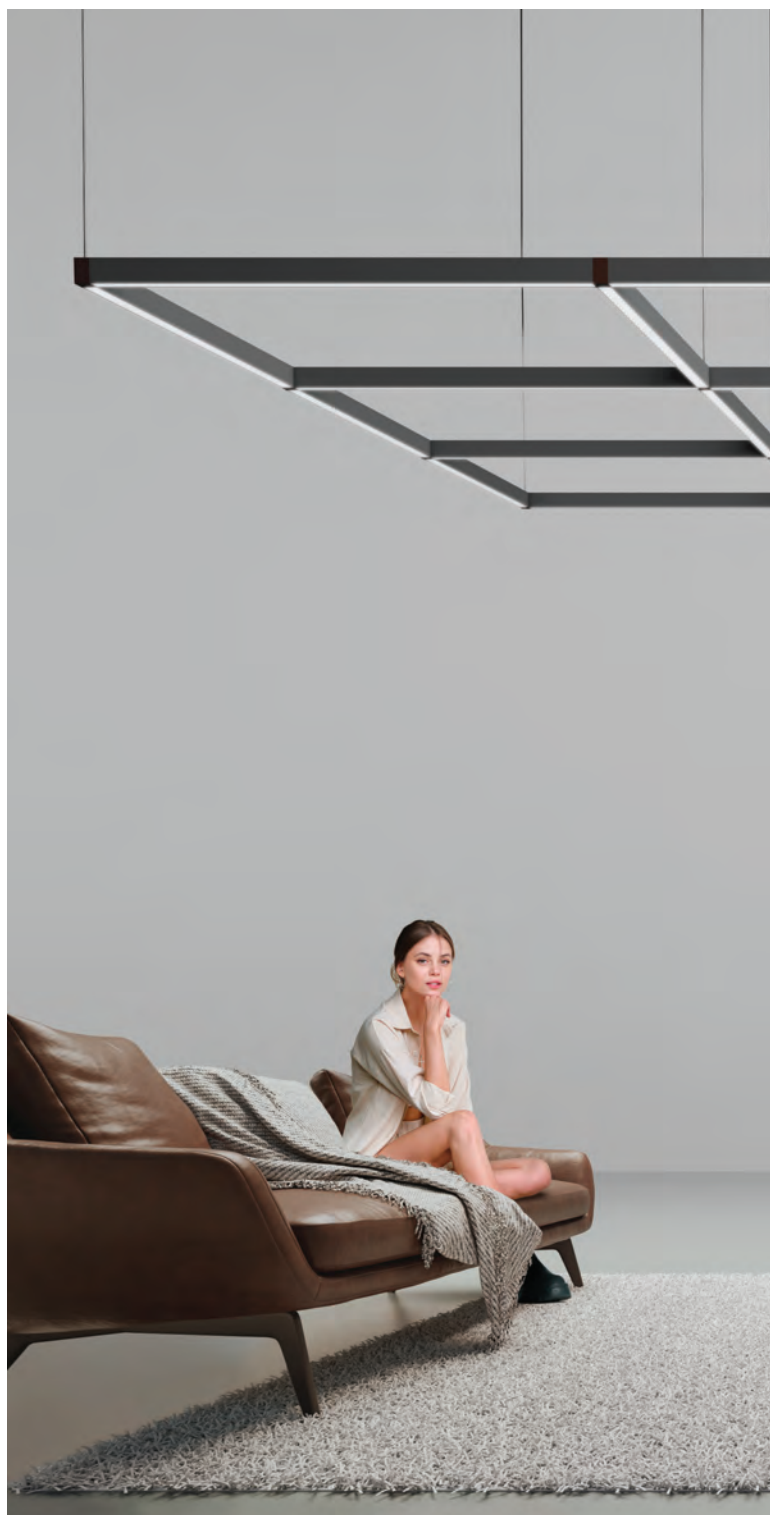



CONFIGURATOR



C O L L E C T I O N S

Non solo "stand alone": Maya amplia il suo campo d'impiego. Con l'utilizzo di pochi, semplici accessori, si ottengono infinite possibilità costruttive. Ogni configurazione si realizza facilmente: forme, misure e sequenze creano sistemi dall'elevato contenuto tecnico ed estetico. Il progetto Maya, conferma la sua valenza e si pone quale riferimento di eccellenza nei diversi campi applicativi.

Not only "Stand alone": Maya widens its range of use. By using a few, simple accessories, infinite constructive possibilities are created. Every configuration is easily achievable: shapes, sizes and sequences create high technical and esthetic systems. The Maya project proofs his worth and poses itself as excellence reference in various fields of application.

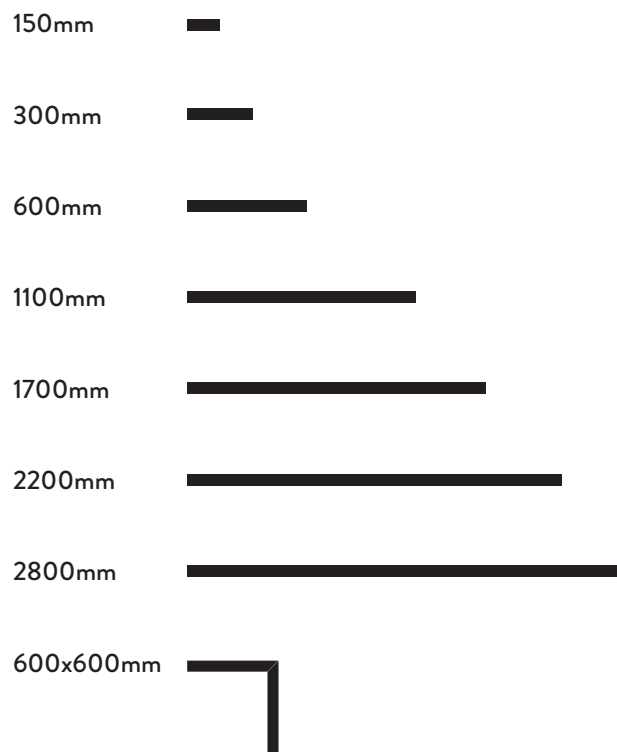

2 models / 8 dimensions /
6 configurations / 5 mountings /
4 emissions / 5 opticals / 6 powers /
5 controls / 4 colour temperatures



C O L L E C T I O N S

p.276

Pendant_
ADJ

Il modello Maya_Adj rappresenta un ulteriore elemento di qualità progettuale del sistema. Questo componente, solitamente combinato con ottiche e riflettori, permette l'orientamento del flusso luminoso (120°). L'impiego di Maya_Adj in combinazione con lo sviluppo lineare del sistema lascia inalterata l'estetica minimale dell'intero impianto. La bancata ottica è disponibile nelle misure 300, 600 e 900mm.

Maya_Adj represents an additional element of design quality of our system. This specific component, usually combined with optics and reflectors, provides the adjustable luminous flux (120°). Maya_Adj combine with the linear development of the system lets unaffected the minimal esthetic of the entire facility. This model is available in 300, 600 and 900 mm lenght.

p.338

Wall_
Pendant

Nuove soluzioni integrano ed ampliano il Sistema Maya. Oltre alla tradizionale applicazione parete, con staffe, è disponibile la versione Wall_Pendant. Ideale per illuminazione di spazi in aderenza con la parete, si configura in tutte le dimensioni, colori e possibilità offerte dal mondo Maya.

New solutions integrate and extend the Maya System. Besides the traditional wall application, with wall bracket, we present the new model WALL_PENDANT is. Ideal for illuminating spaces in adherence with the wall, can be configured in all dimensions, colors and possibilities offered by the Maya world.



p.062

Recessed

Maya Incasso, completa le potenzialità del sistema. Si configura come stand alone oppure come sistema. È disponibile con installazione trimless e con cornice a vista. La gamma si divide in due modelli principali: con piano ottico a filo (Maya Filo) e con piano ottico arretrato (Maya Dark). Maya Incasso, mantiene le stesse caratteristiche di Maya per misure, gestioni elettroniche, ottiche e continuità con i diversi elementi. Garantisce efficienze luminose al vertice di categoria ed impiega elementi elettronici di ultima generazione. La scelta del modello è estremamente semplice con l'utilizzo del configuratore Maya.

Maya recessed completes the universality of the complete system. It can be configured either system or "stand alone". It's available with trimless installation and frame at sight. The range can be divided in two major models: with wire optical plane (Maya Filo) and landed optical plane (Maya Dark). Maya recessed maintains the original Maya characteristics for measurements, electronic features, optics and continuity with different elements. It guarantees luminous efficiency on top category and highest Standard on electronic components. The choice of the model is really simple through the use of the Maya configurator.



p.226

Ceiling

p.212

Track

La serie MAYA è disponibile anche per installazioni su binario. Quattro modelli standard: 600, 1100, 1700 e 2200. Aumenta la flessibilità del sistema che permette l'impiego anche in installazioni complesse. La nostra proposta prevede modelli ON-OFF e DALI, molteplici colori della scocca, a scelta emissioni diffuse (120° - microprismatico) oppure spot (50° - 80°).

MAYA range now available for track installations. Four standard models: 600, 1100, 1700 and 2200. Our offer increases the flexibility of the system that allows its use even in complex installations. Our proposal includes models ON-OFF and DALI, multiple colors of the body, a choice of diffuse emissions (120° - microprismatic) or spot (50° - 80°).



C O L L E C T I O N S

MAYA
mini

Con Maya_Mini si riducono le dimensioni del profilo per aumentarne attrattiva e funzionalità. Nuove idee con modelli esclusivi e finiture innovative. Diverse le versioni: sospensione, parete, soffitto con flusso luminoso orientabile oppure fisso. Due le versioni di Lampade da terra: "Office", per impieghi professionali ed "Ambient", una lampada per uso domestico disponibile anche con l'innovativa tecnologia voice control. Le finiture del prodotto diventano caratteristica primaria ed aprono a combinazioni accattivanti facilmente selezionabili con il configuratore dedicato. Viene meno il rigore tecnico con cui si è soliti trattare l'apparecchio d'illuminazione e si creano nuovi standard nel mondo lighting.

Maya_Mini Project reduce the profile dimensions to increase attractiveness and functionality. We present new ideas with exclusive models and innovative finishes: suspension, wall, ceiling with adjustable or fixed luminous flux. Two versions of floor lamps: "Office", for professional use and "Ambient", for domestic use also available with the innovative voice control technology. The finishes of the product become the primary feature and open up to captivating combinations that can be easily selected with the dedicated configurator. The technical details with which it is customary to treat the luminaire change! New standards and new approach to created a better feeling.

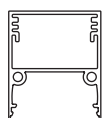

42x50mm





CONFIGURATOR



C O L L E C T I O N S

4 mountings / 4 emissions /
5 opticals / 6 powers / 7 controls /
5 colour temperatures /
13 structure colours

MAYA_mini
Pendant_p.284



MAYA_mini
Ceiling_p.234

Colours

White, Black, Tobacco, Lunar Grey, Antique Marble, Concrete, Old Zebra*, Oman Red*, Desert Camouflage*, Green Grass*, Beech Wood, Oak Wood, Walnut Wood



MAYA_mini
Adj_p.342

L'allargamento della gamma Maya_Mini propone soluzioni all'avanguardia nella tecnologia e nell'estetica. Maya_Mini_Adj si candida ad occupare un posto di rilievo nella sezione della luce proiettata. Le ottiche in uso sul sistema vengono proposte con schede Led di diversa dimensione: 300/600/900 mm. Flussi luminosi importanti, con ottiche a scelta tra 50° ed 80°, possono essere installate a soffitto, a parete, a terra. Orientabilità del flusso luminoso di 120° a destra e sinistra sull'asse.

The expansion of Maya_Mini range offers cutting-edge solutions in aesthetics and technology. Maya_Mini_Adj is a candidate for a prominent place in our projected light section. The optics used on the system are offered with Led boards of different sizes: 300/600/900 mm. Important luminous fluxes, with optics between 50° and 80°, can be installed on the ceiling, wall, ground. Lumen flux can be adjusted 120° on right and left of central axis.

Le lampade da terra occupano uno spazio centrale nel progetto Maya_Mini. Due i modelli concepiti per impieghi differenti: "Ambient" per utilizzo domestico e finalità prettamente decorative. Disponibile in configurazione monocromatica On/Off. La versione domotica permette la gestione Monocromatica, RGBW e Tunable White. La versione "Office" nasce invece per impieghi specifici e professionali. Si rivolge all'utenza più esigente e qualificata per illuminare e valorizzare desk, piani lavoro ed ambienti operativi in genere. Ogni apparecchio mantiene gli alti standard qualitativi e tecnici già evidenti nella linea Maya.

The floor lamps have a special attention on Maya_Mini project. Two models designed for different uses: "Ambient" for domestic use and decorative purposes. Available in monochromatic On/Off configuration or home automation version Monochromatic, RGBW and Tunable White. The "Office" version, is indicated for specific and professional uses. It is aimed at the most demanding level and qualified users to enhance desks, worktops and operating environments in general. Each product keeps the high quality and technical standards as evident in the Maya line.

MAYA_mini
Floor_p.402



C O L L E C T I O N S

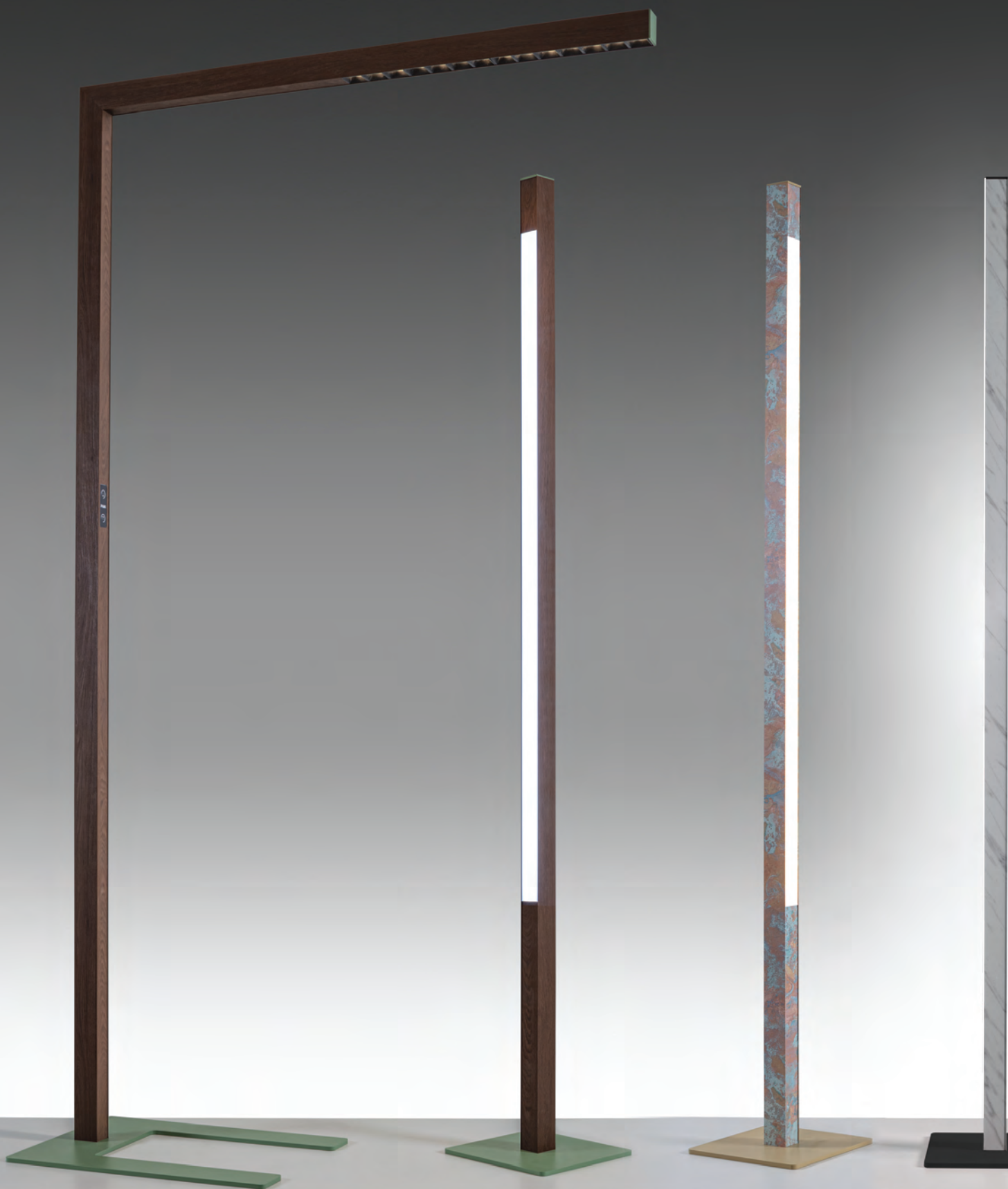

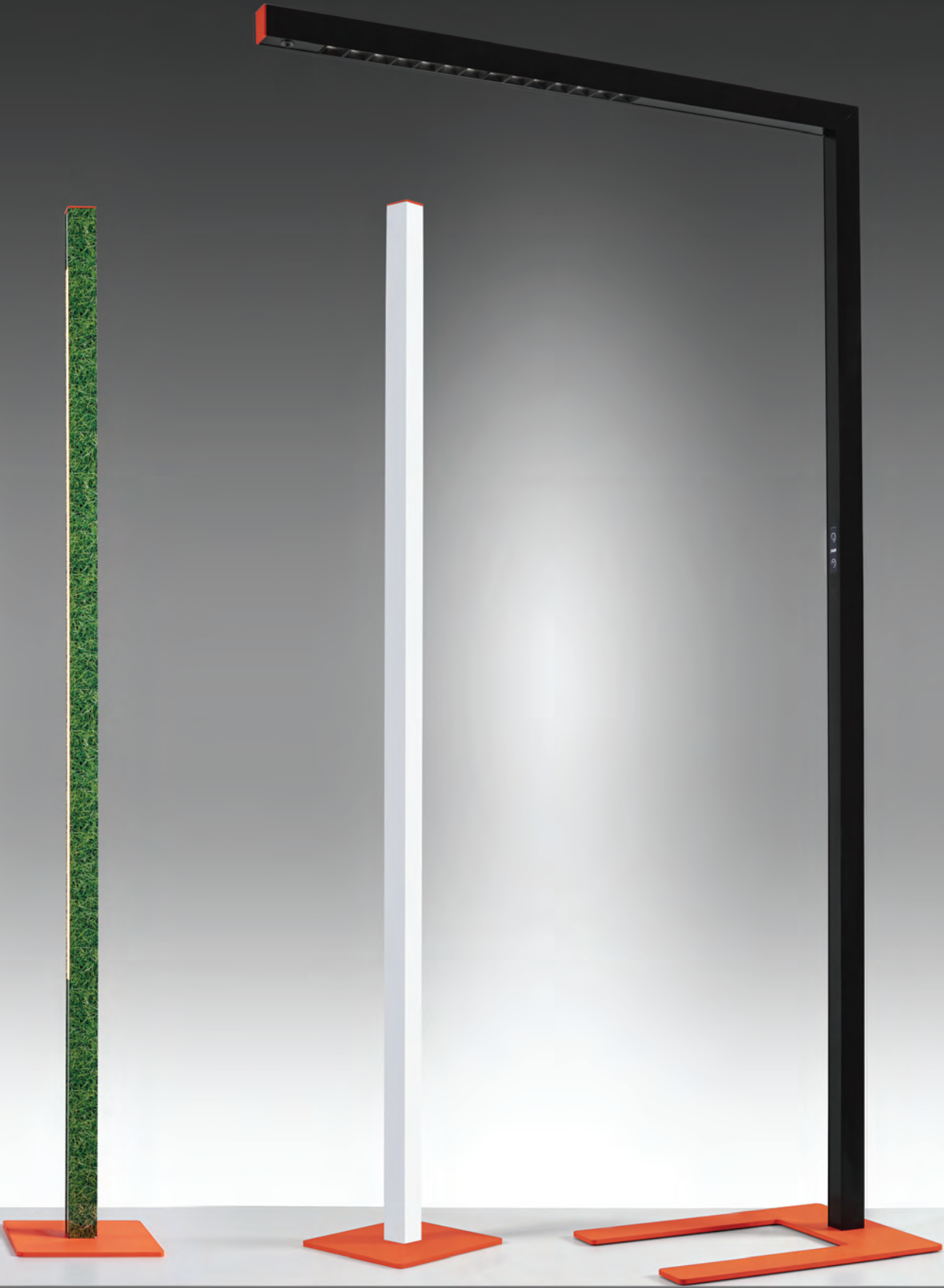

COLLECTIONS

EXTREME COLLECTIONS

Estetica contemporanea e funzionalità avanzate sono i caratteri principali della collezione Extreme. Diverse le tipologie d'installazione: track, parete-soffitto, incasso e semi-incasso. Una gamma di prodotti che garantisce installazioni dal marcato carattere ed alto standard tecnologico. La generatrice formale, apparentemente semplice e dalle ridotte dimensioni, diventa il fulcro su cui installare tecnologie e colori che definiscono una proposta di alto contenuto.

Contemporary aesthetics and advanced functionality are the main characters of the Extreme collection. Different types of installation: track, wall-ceiling, recessed and semi-recessed. A range of products that guarantees installations with a marked character and high technological standard. The formal generator, seemingly simple and small in size, becomes the fulcrum on which install technologies and colors that define a proposal of high content.

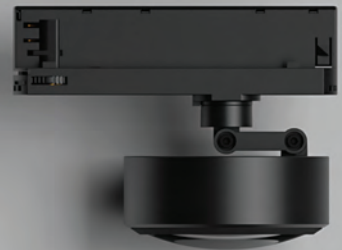
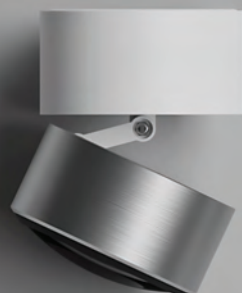

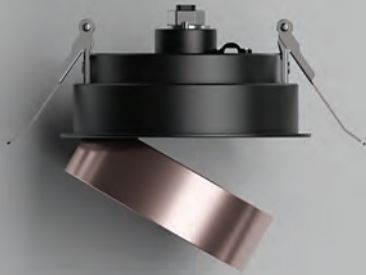

C O L L E C T I O N S

4 mountings / 5 opticals /
2 powers / 4 controls /
3 colour temperatures /
6 ring colours



Track_
p.208



Ceiling/Wall_
p.240



Semirecessed_
p.078



Recessed
p.080



Extreme è una collezione trasversale ed integrata. Molteplici idee per un comune utilizzo. Alimentazioni On/Off e DALI su binario ed incasso. Versioni parete e soffitto completano l'offerta. I colori, ottenuti con trattamento speciale dell'anello in alluminio qualificano marcatamente gli ambienti in cui vengono installati.

Extreme is a transversal and integrated collection. Multiple ideas for common use. On/Off and DALI power supplies on track and recessed. Wall and ceiling versions complete the offer. The colors, obtained with special treatment of the aluminum ring, strongly qualify the environments in which they are installed. An online configurator helps and simplifies the choices and the selection of products.

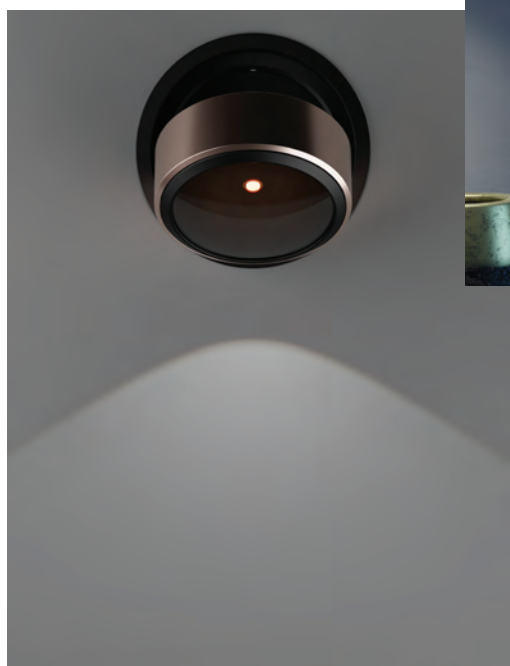

N E W S

SEAL



Extended family_p.374



PRODUCT INDEX

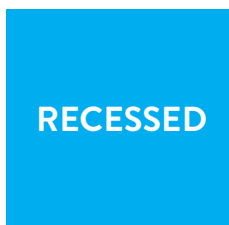

Karma_p.056

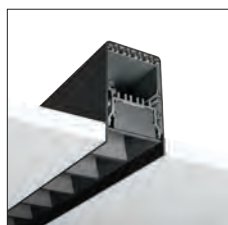

Maya_p.062



Slim_p.072



Extreme_p.076



Sinergy_p.082



Nemo_p.086



Egon_p.118



Moby_p.120



Bobby_p.124



Jango_p.126



Show IP65_p.128



Focus_p.130



Pill_p.138



Microled_p.140



Miniled_p.142



Plaster_p.144



GU10_p.158

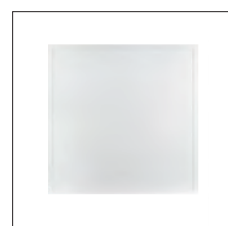
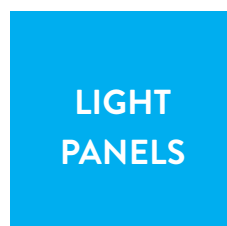

Backlit_p.166



Backlit UGR_p.168



Led Panel Smart_p.170

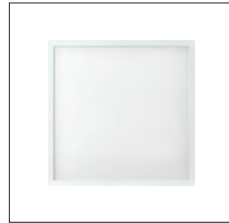

Led Panel Microprismatic_p.172

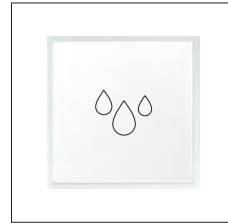

Led Panel IP65_p.174



Led Panel Tunable_p.176



Panel Box_p.180

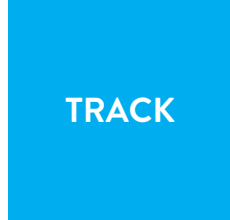

Slim_p.192



Ska_p.200



Sinergy_p.204



Extreme_p.208



Maya_p.212

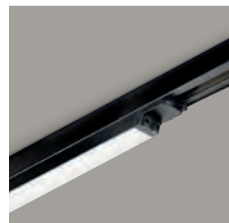

Day_p.216



Karma_p.220

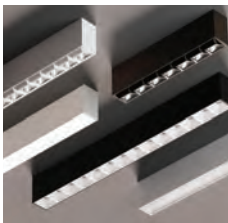

Maya_p.226

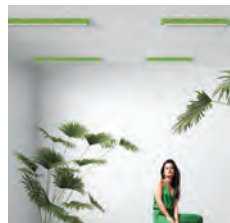

Maya Mini_p.234



Extreme_p.240



Ska_p.244



Slim_p.248



Hoop_p.252



Corona_p.253



Penny_p.254



Kart_p.256



Bike_p.257



Young_p.258



Play_p.260



Dama_p.262

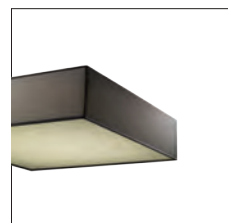

Urano_p.264

PENDANTS

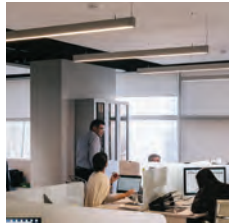

Karma_p.268



Maya_p.276

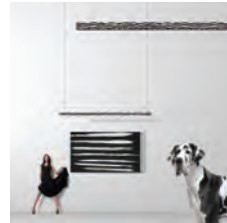

Maya Mini_p.284



Bahia_p.288



Hoop_p.290



Corona_p.292



Bike_p.294



Penny_p.296



Kart_p.298



Infinity_p.300



Lunar_p.302



Cross_p.304

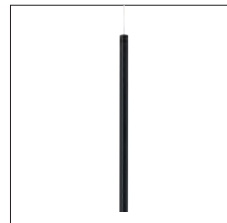

Stek_p.306



Lupin_p.308



Giove_p.310



Saturno_p.312

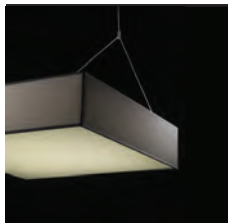

Urano_p.314

WALL

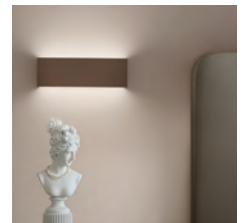

Quik_p.318

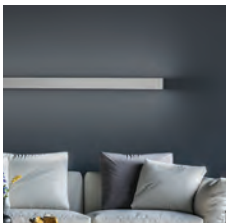

Karma_p.326



Maya_p.332



Maya Mini_p.340

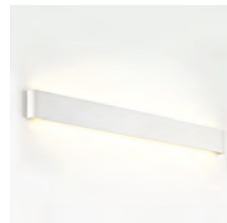

Match_p.344

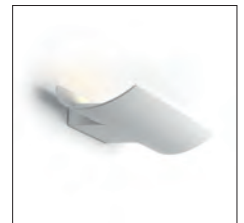

Onda_p.345



Elle_p.346

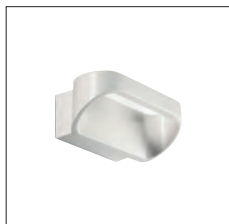

Grace_p.347

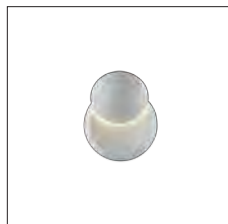

Eclis_p.348

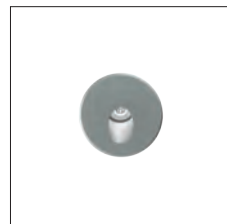

Polka_p.350



Fast_p.352



Alyson_p.356

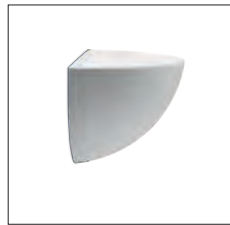

Pod_p.358



Boreale_p.359



Idra_p.360



Tube_p.361



Oberon_p.362



Ely_p.363

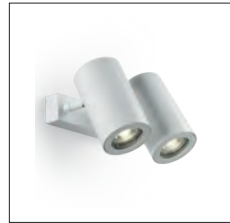

Lupin_p.364



Dippy_p.366



Pako_p.367



Berlin_p.368



London_p.369



Paris_p.370



Cama_p.371



Soft_p.370



Jazz_p.371

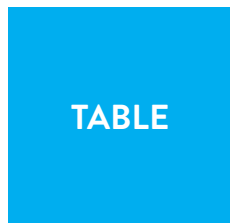

TABLE

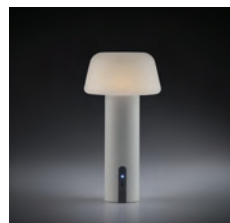

Seal_p.374



Sunny_p.376



Smart_p.380



Asia / Asia Mini_p.382



Rex_p.384



Joy_p.386



Sol_p.388



Yab_p.392



Summer_p.394



Mida_p.395



Alter_p.396



Milla_p.398



Soft_p.399

FLOOR



Maya Mini_p.402



Lunar_p.410



Soft_p.412



Bow_p.414



Shade_p.416



Maiko_p.418



Zaria_p.420

INDUSTRIALS



Puck Extra_p.424



Beam_p.426

PROFILI

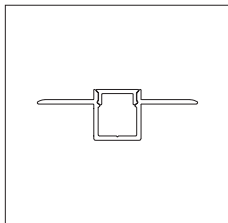

Plasterboard Recessed_p.436

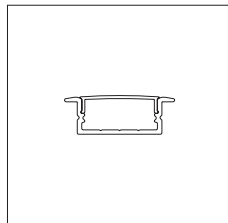

Recessed_p.452

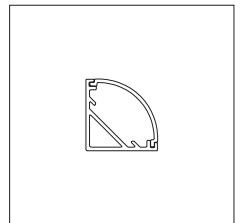

Surface mounted_p.458

STRIPLED INDOOR



CoB Line_p.474



CoB Evo_p.476



Mini_p.478



Light Line_p.480



High efficiency_p.482



Colour quality_p.484



Tunable_p.486



RGB+3000K_p.487

STRIPLED OUTDOOR



Neon Flex 2.0_p.490

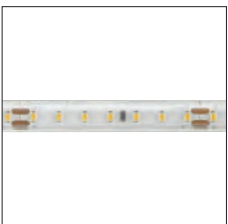

Light line Waterproof_p.494

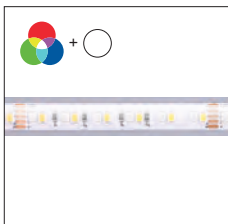

RGB+3000K_p.496

**CONTROLLED
E DRIVERS**

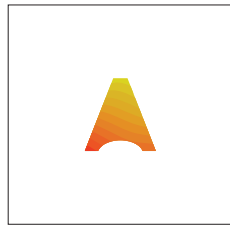

Casambi_p.502

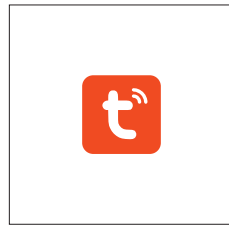

Tuya_p.504

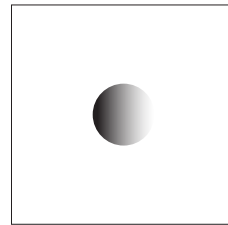

Monochrome
control system_p.508

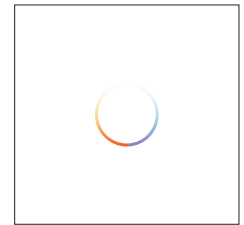

Tunable
control system_p.511

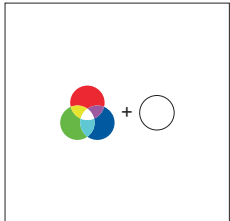

RGB+W
Control system_p.518

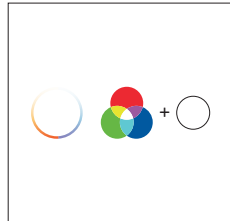

Control system_p.518

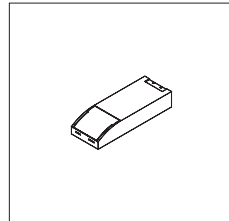

Drivers_p.519

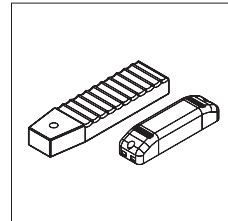

Emergency Kit_p.522

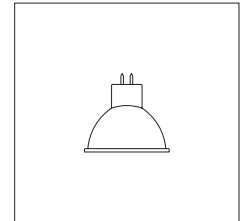

Light Sources_p.524

INFO

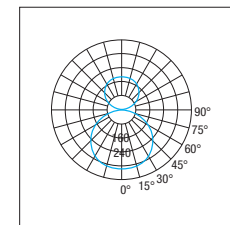

Optical systems_p.526

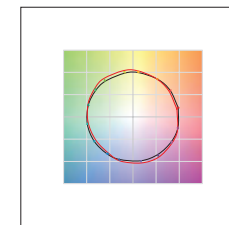

Colour rendering_p.538

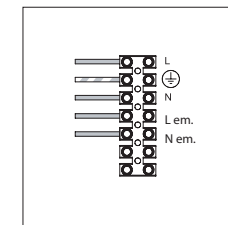

Wiring diagrams_p.542



RECESSED

01

I N D E X



Karma_p.056



Maya_p.062



Slim_p.072



Extreme_p.076



Sinergy_p.082



Nemo_p.086



Egon_p.118



Moby_p.120



Bobby_p.124



Jango_p.126



Show IP65_p.128



Focus_p.130



Pill_p.138



Microled_p.140



Miniled_p.142



Plaster_p.144



GU10_p.158

KARMA_Recessed



Karma Trimless è un sistema per l'illuminazione lineare da incasso, installabile a filo del controsoffitto in modo semplice e rapido e mantenendo totalmente nascosto il bordo di battuta. Le operazioni di rasatura del soffitto si completano totalmente prima dell'installazione elettrica, che può quindi essere svolta in totale pulizia e in assenza di polvere. Le versioni ad incasso trimless sono costituite da moduli strutturali che si montano su appositi telai da controsoffitto grazie ad un sistema di molle a scatto rapido "Click&Lock". Karma trimless è disponibile come elemento singolo oppure a sistema e permette il montaggio su linee continue.

Karma Trimless is a system for linear recessed lighting, which can be simply and fastly installed trimless. The ceiling finishing operations are completed before the electrical installation, which can be carried out in total cleanliness and without powder. The trimless recessed versions are made from structural modules that are installed on false ceiling frames thanks to the "Click & Lock" snap spring system. Karma trimless is available as a single or system element and allows mounting on continuous lines.



+ KARMA Pendant pag 268

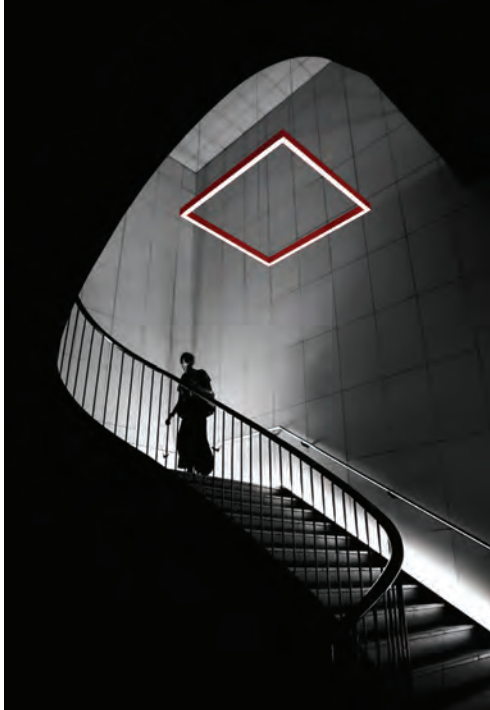

+ KARMA Ceiling pag 220



EXTENDED
COLLECTION

+ KARMA Wall pag 326

Karma_Recessed

Installation

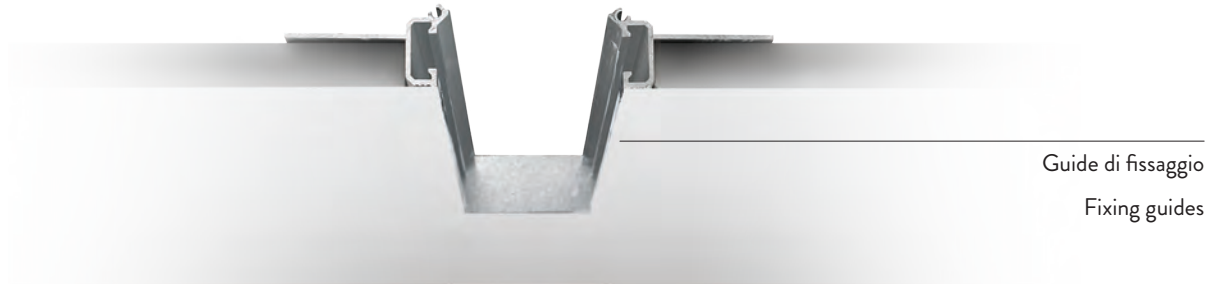

Click & Lock

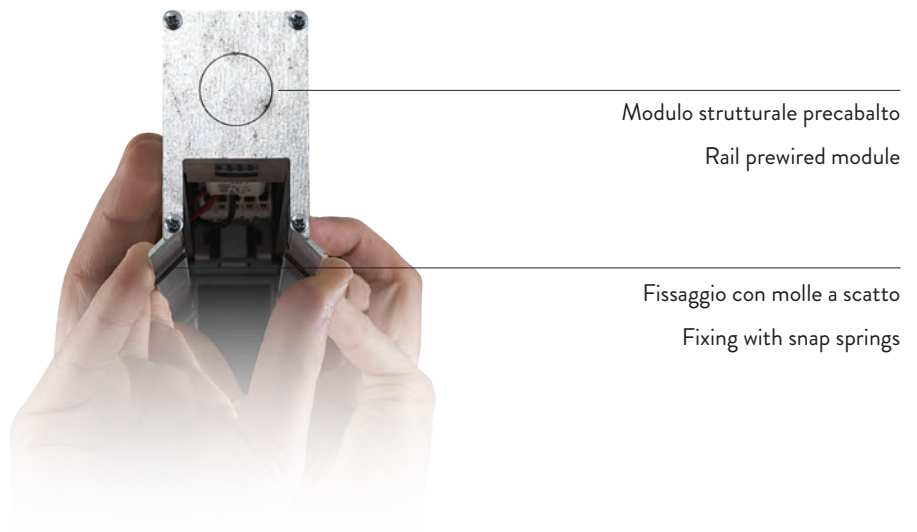

Click & Light

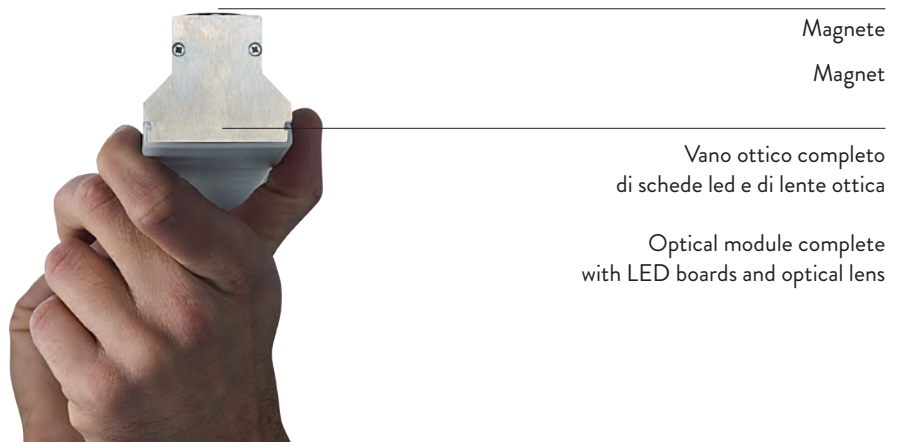

Installazione delle guide di fissaggio - Fixing guides installation

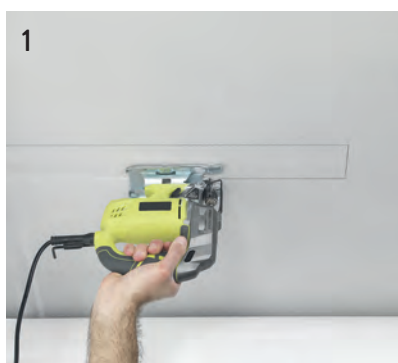

1 - Taglio del cartongesso.
Plasterboard cutting.

2 - Inserimento delle guide di fissaggio
(telaio preassemblato).
Inserting of fixing rails (pre-assembled frame).

3 - Fissaggio delle guide al cartongesso.
Fixing of the rails to the plasterboard.

4 - Stuccatura a filo e tinteggiatura finale.
Trimless grouting and final painting.



Installazione dei moduli ottici - Optical modules installation



5 - Inserimento del modulo strutturale a scatto e collegamento alla rete.
Insertion of the snap-in rail module and connection to the mains.

6 - Fissaggio cavo di sicurezza con sistema "grip-lock" e cablaggio fast-plug del modulo ottico.
Safety cable fixing with grip-lock system and optical module fast-plug wiring.

7 - Inserimento del vano ottico a fissaggio magnetico senza utensili.
Insertion of the optical compartment with magnetic no tools fixing.

8 - Accensione finale.
Turn it on.



KARMA_Recessed

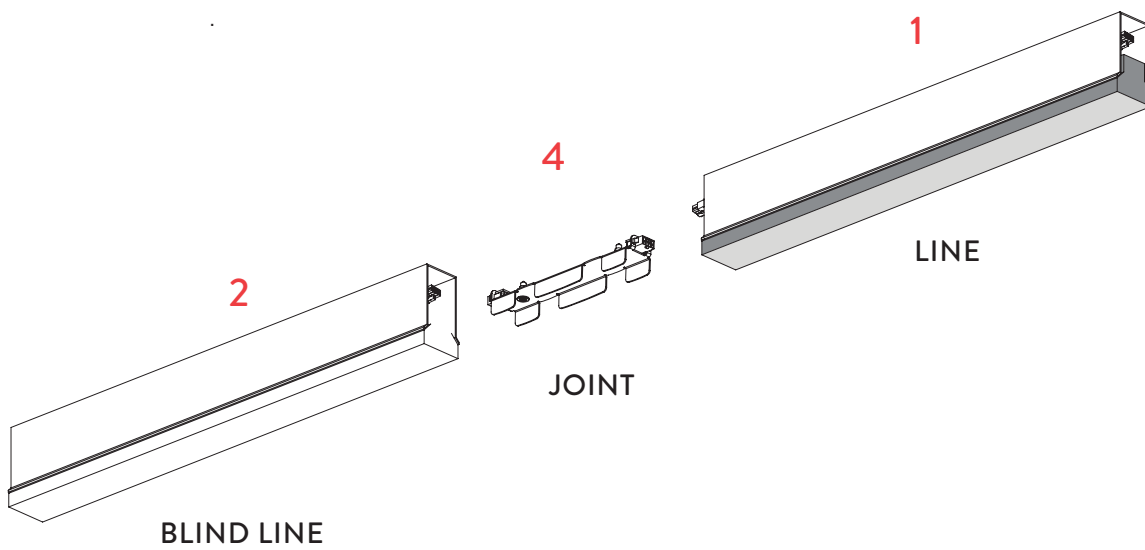
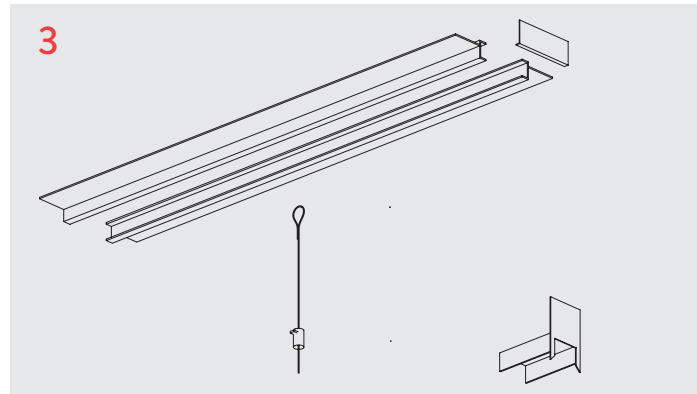
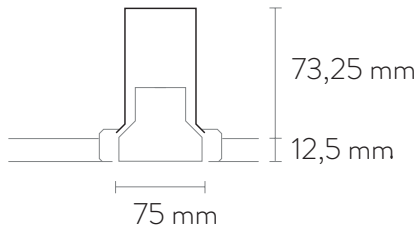

1 Line Downlight

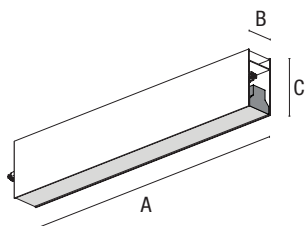

Model	Power	Lumen output	Product dimension			* code to complete
			A	B	C	
600	12 W	1518 lm	573 mm	55 mm	86 mm	SE-TAAAA ■ ▲ □
1100	24 W	3036 lm	1131 mm	55 mm	86 mm	SE-TAABC ■ ▲ □
1700	36 W	4554 lm	1691 mm	55 mm	86 mm	SE-TAACD ■ ▲ □
2200	48 W	6072 lm	2250 mm	55 mm	86 mm	SE-TAADE ■ ▲ □

⊕ 220÷240Vac | IP20 UP to 127 lm/W | UP to UGR≥16 | L80/B20 80.000 h. | CRI>90 | UP to RG0 | SDCM<3
Lumen output values: luminaire luminous flux at 4000 K - optics 50°

2 Blind Line

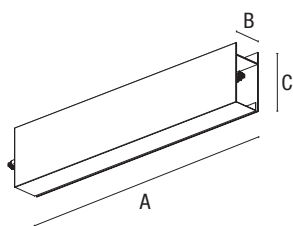

Model	Power	Lumen output	Product dimension			* code to complete
			A	B	C	
600	/	/	573 mm	55 mm	110 mm	SE-TAEA ●
1100	/	/	1131 mm	55 mm	110 mm	SE-TAEB ●
1700	/	/	1691 mm	55 mm	110 mm	SE-TAEC ●

3 Accessories Recessed

Description	* code to complete
Safety Cable (2x line 300, 600, 1100 - 3x line 1700, 2200)	ATS05300
End Cap (2x)	ATS07202
Mounting kit for profiles 573mm	ATS07205
Mounting kit for profiles 1131mm	ATS07206
Mounting kit for profiles 1691 mm	ATS07207
Mounting kit for profiles 2250mm	ATS07208

4 Joint

Description	code
Metal connection	ATS07304

Optical Info p. 528

* Select your option

CCT	Optic	Colour	Control	#
2700 K 1	60° B	White W	On/Off NF	Only: 120° - DALI(DT8), Casambi
3000 K 2	90° C	Black B	DALI DA	** Only: 1700 - 2200
4000 K 3	120° E	Corten C	Em. 1h ** H1	*** Configurations up to max 2800 mm length
Tunable # % 4	Asy F	Lunar Grey G	Casambi **** CA	% Only: 1100 - 1700 - 2200
	Sym G	Tobacco O	Push *** PU	

Finishes

White Black Corten Lunar Grey Tobacco



MAYA_Recessed



Maya Recessed estende il campo di applicazione Maya alle installazioni incassate. Il prodotto è disponibile in versione stand alone e sistema. Due le tipologie principali: incasso con bordo e trimless. Ampia la scelta legata alle innumerevoli varianti per misure, gestioni, ottiche e colori. Un configuratore avanzato, presente sul nostro website, semplifica le scelte. Maya incasso esprime design curato, efficienza tecnologica ed estetica. Il prodotto è realizzato con estruso in alluminio verniciato con polveri epossidiche. La gestione elettronica è affidata a componenti di primissimo livello in grado di garantire le migliori prestazioni per efficienza e stabilità nel tempo. È coperta l'intera gamma di alimentazione: On/Off, Dali, Push, Casambi. Maya impiega schede Led ad alta efficienza nelle varianti 2700K, 3000K e 4000K nonché una versione tunable white.

Maya Recessed expands the Maya range to recessed installations. The product is available in both stand-alone and system versions. There are two main types: with a visible edge and trimless. There is a wide selection available, with countless variations in sizes, control options, optics, and colors. An advanced configurator, available on our website, simplifies the choices. Maya Recessed embodies well-designed aesthetics, technological efficiency, and aesthetics. The product is made with extruded aluminum painted with epoxy powders. The electronic management relies on top-quality components capable of guaranteeing the best performance in terms of efficiency and long-term stability. The entire range of power supply options is covered: On/Off, Dali, Push, Casambi. Maya utilizes high-efficiency LED boards in 2700K, 3000K, and 4000K variants, as well as a tunable white version.



EXTENDED COLLECTION

+ MAYA Wall pag 332



+ MAYA Pendant pag 276



+ MAYA Track pag 212

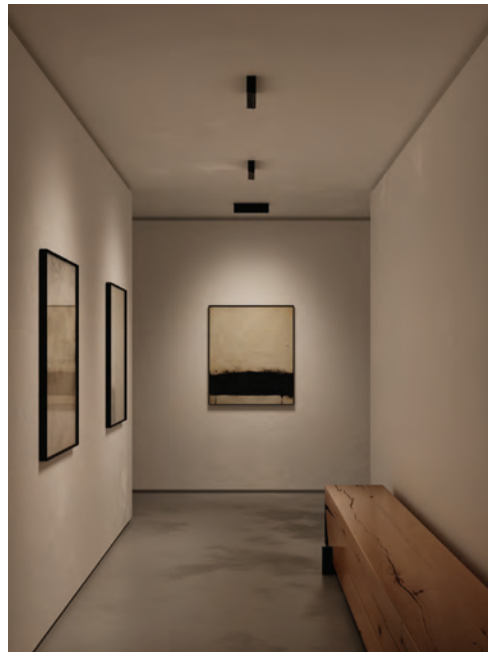

+ MAYA Ceiling pag 226

MAYA_Recessed

MODEL

150

300

600

1100

1700

2200

2800

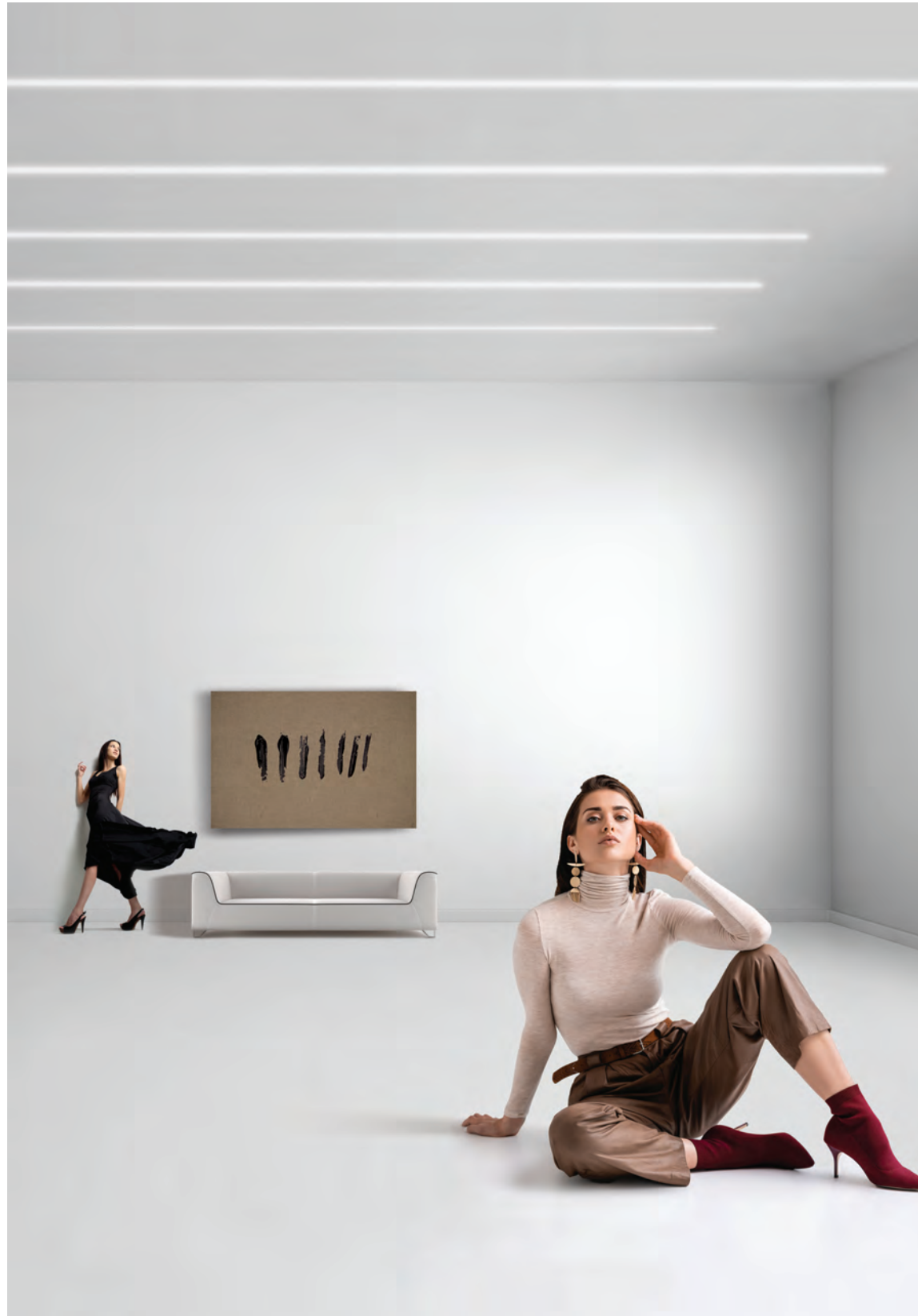

Trimmed_Filo

Questo modello, adatto ad installazioni su soffitti in cartongesso, legno e metallo, si caratterizza per il bordo a vista. Due i colori disponibili: bianco e nero. Questa costruzione prevede l'allineamento del diffusore o delle ottiche con il filo del soffitto in cui viene installato.

This model, used for installation on plasterboard ceilings, wood and metal, has its particularity on the visible frame. Two available colors: black and white. This construction includes the alignment between optical with the wire of the ceiling it's supposed to be installed.

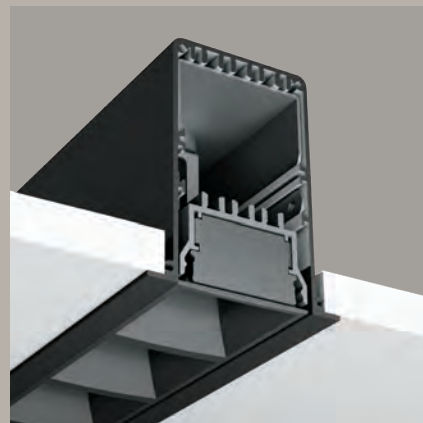

Trimmed_Dark

La versione "Dark" mantiene tutte le caratteristiche del modello e differisce per la posizione del piano ottico. In questa configurazione la linea led viene arretrata nel profilo e garantisce un maggior comfort visivo. L'effetto DARK viene massimizzato in associazione alle ottiche disponibili con riflettori bianchi o neri.

The "Dark" version maintains all the characteristic of the original model and differs for the position of the optical level. LED line is set back in the profile and guarantees the best UGR control. The dark effect is maximized in association with optic available with white or black reflectors.

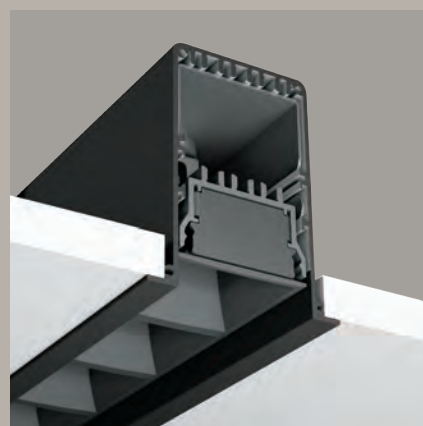

Trimless_Filo

Questo modello è specifico per installazioni su soffitti in cartongesso. Ha in dotazione una staffa che garantisce il fissaggio del profilo e scompare alla vista lasciando visibilità al solo elemento luminoso. La versione "Trimless filo" prevede l'allineamento del diffusore o delle ottiche con il filo del soffitto in cui viene installato.

This model is the specific one for plasterboard ceilings. A bracket unit guarantees the fixing of the profile and disappears from sight leaving visibility at the only lighting element. The "Trimless filo" version has the alignment of the diffuser and optics with the wire of the ceiling it has been installed.

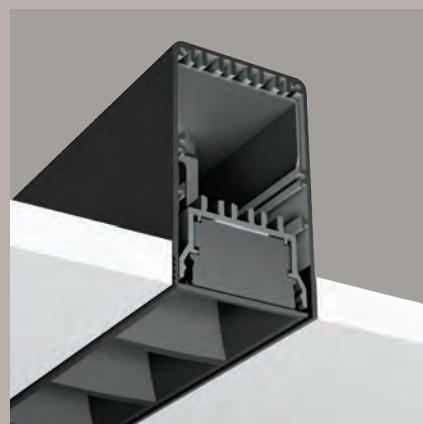

Trimless_Dark

La versione Dark mantiene tutte le caratteristiche del modello "filo" e differisce per la posizione del piano ottico. In questa configurazione la linea led viene arretrata nel profilo e garantisce un maggior comfort visivo. L'effetto Dark viene massimizzato in associazione alle ottiche disponibili con riflettori bianchi o neri. Il profilo nella versione Dark viene proposto in associazione al colore delle ottiche (bianco o nero).

the Dark version has all the characteristics of the wire model and defers for the positing of the optical plane. In this configuration the LED line is set back in the profile and guarantees the best UGR control. The Dark profile version is proposed in color association of optics (white/black).

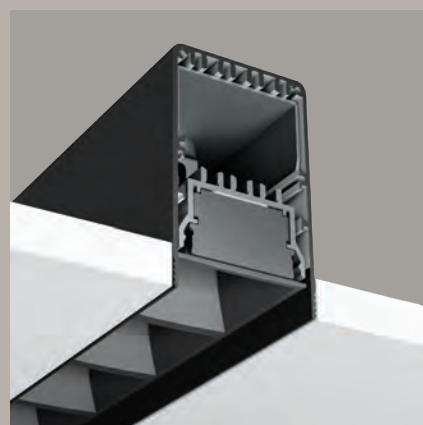

MAYA_Recessed

OVERVIEW

Trimless

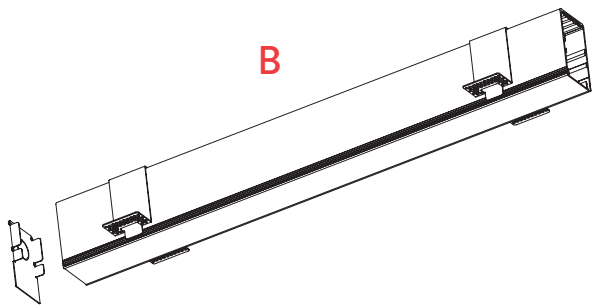

Trimmed

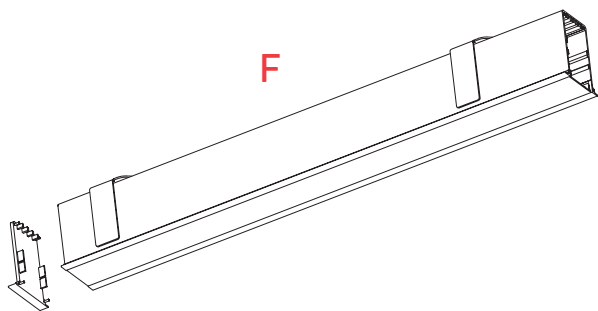

C
JOINT

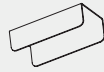

Metal connection

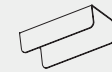
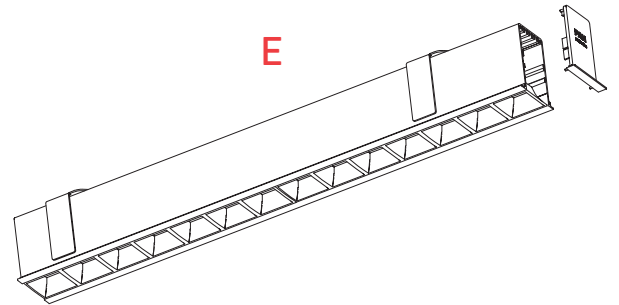
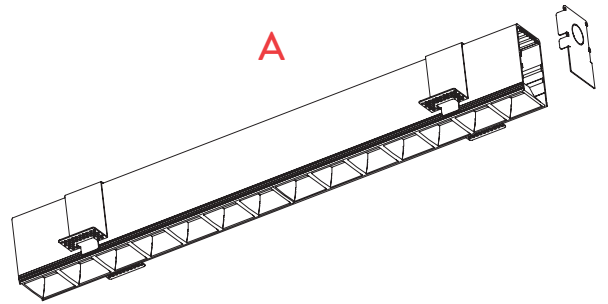

Metal connection

ACCESSORIES

D



Safety cable

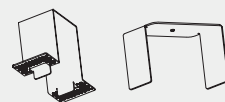

Fixing Clip

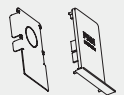

End Cap

Trimmed

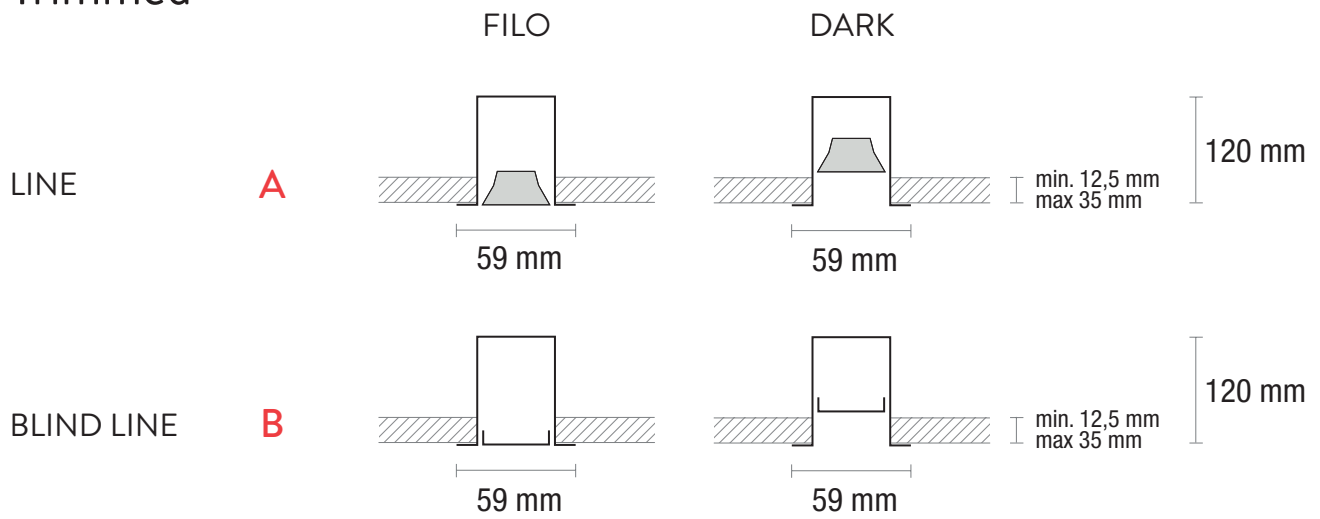

Trimless

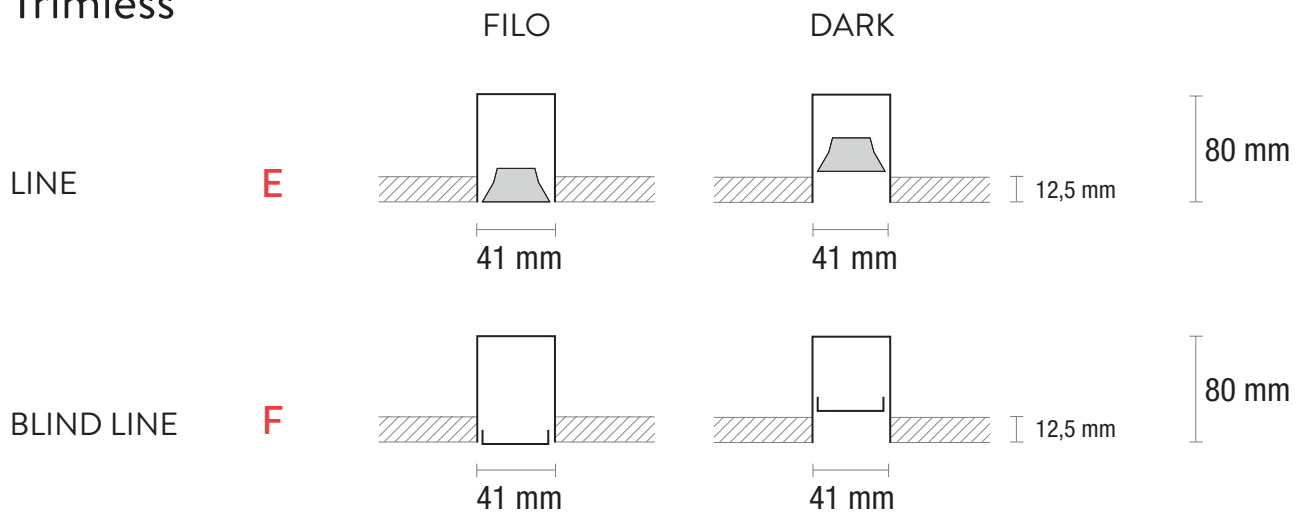

SYSTEM COMPOSITION

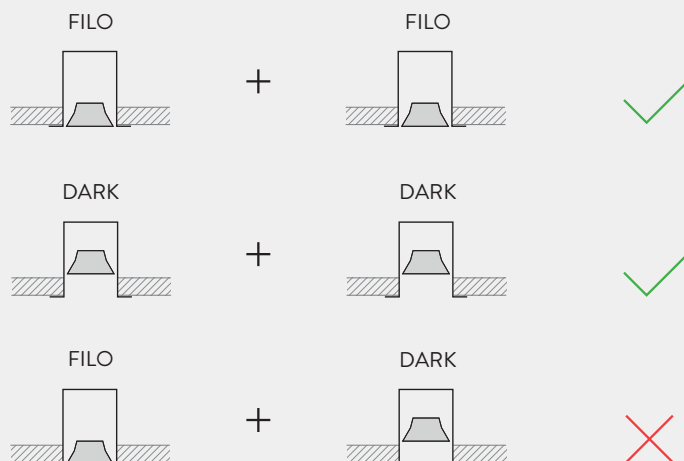

MAYA_Recessed Trimmed

Line - Filo

A

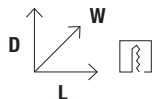
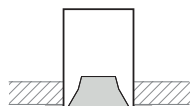

Model	Power	Hole size (mm)			Lumen output	*code to complete
		Width	Length	Depth		
150 ∞	6 W	50	167	120	790 lm	SM-AAAYQ ■ △ ● □
300 ◇	6 W	50	287	120	760 lm	SM-AAAVQ ■ △ ● □
600	12 W	50	567	120	1518 lm	SM-AAAAA ■ △ ● □
1100	24 W	50	1127	120	3036 lm	SM-AAABC ■ △ ● □
1700	36 W	50	1687	120	4554 lm	SM-AAACD ■ △ ● □
2200	48 W	50	2247	120	6072 lm	SM-AAADE ■ △ ● □
2800	60 W	50	2807	120	7590 lm	SM-AAAWF ■ △ ● □

⊕ 220÷240Vac | IP20

UP to 127 lm/W | UP to UGR≥16 | L80/B20 80.000 h. | CRI>90 | UP to RG0 | SDCM<3
Lumen output values: luminaire luminous flux at 4000 K - optics 50°

Line - Dark

A

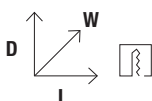
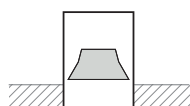

Model	Power	Hole size (mm)			Lumen output	*code to complete
		Width	Length	Depth		
150 ∞	6 W	50	167	120	790 lm	SM-CAAYQ ■ △ ● □
300 ◇	6 W	50	287	120	760 lm	SM-CAAVQ ■ △ ● □
600	12 W	50	567	120	1518 lm	SM-CAAAA ■ △ ● □
1100	24 W	50	1127	120	3036 lm	SM-CAABC ■ △ ● □
1700	36 W	50	1687	120	4554 lm	SM-CAACD ■ △ ● □
2200	48 W	50	2247	120	6072 lm	SM-CAADE ■ △ ● □
2800	60 W	50	2807	120	7590 lm	SM-CAAWF ■ △ ● □

⊕ 220÷240Vac | IP20

UP to 127 lm/W | UP to UGR≥16 | L80/B20 80.000 h. | CRI>90 | UP to RG0 | SDCM<3
Lumen output values: luminaire luminous flux at 4000 K - optics 50°

Optical Info p. 528

*** Select your option**

CCT	Optic	Colour	Control	#
2700 K 1	120° E	White W	On/Off NF	Only: 120° - DALI(DT8), Casambi
3000 K 2	Micro M	Black B	DALI DA	** Only: 1700 - 2200 - 2800
4000 K 3	50° White N		Em. 1h ** H1	*** Configurations up to max 2800 mm length
Tunable # 4	50° Black O		Casambi CA	
	80° White P		Push *** PU	
	80° Black Q			∞ Only: Stand Alone / no Asy Optic
	Asy White R			
	Asy Black S			◇ Stand Alone only

Blind Line - Filo

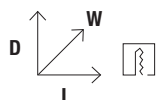
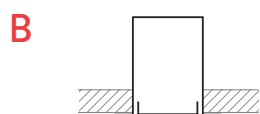

Model	Hole size (mm)			* code to complete
	Width	Length	Depth	
600	50	567	120	SM-AAEA ●
1100	50	1127	120	SM-AAEB ●
1700	50	1687	120	SM-AAEC ●
2200	50	2247	120	SM-AAED ●

Blind Line - Dark

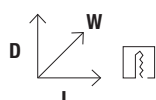
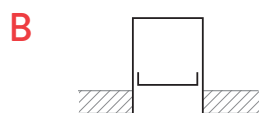

Model	Hole size (mm)			* code to complete
	Width	Length	Depth	
600	50	567	120	SM-CAEA ●
1100	50	1127	120	SM-CAEB ●
1700	50	1687	120	SM-CAEC ●
2200	50	2247	120	SM-CAED ●

Accessories

D

Description	* code to complete
Safety cable (2x)	CSS05300
Fixing Clip (2x 300, 600, 1100 - 3x 1700, 2200, 2800)	CSS07206
End Cap (2x)	CS ▼ 07203

Joint

C

Metal connection	CSS07304
------------------	-----------------

* Select your option

Colour	End Cap Colour
White W ●	White W ▼
Black B	Black B

MAYA_Recessed Trimless

Line - Filo

E

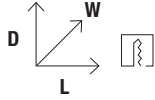
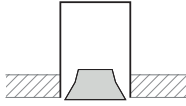

Model	Power	Hole size (mm)			Lumen output	*code to complete			
		Width	Length	Depth					
150 ∞	6 W	46	159	80	790 lm	SM-BAAYQ	■	△	□
300 ◇	6 W	46	279	80	760 lm	SM-BAAVQ	■	△	□
600	12 W	46	559	80	1518 lm	SM-BAAAA	■	△	□
1100	24 W	46	1119	80	3036 lm	SM-BAABC	■	△	□
1700	36 W	46	1679	80	4554 lm	SM-BAACD	■	△	□
2200	48 W	46	2239	80	6072 lm	SM-BAADE	■	△	□
2800	60 W	46	2799	80	7590 lm	SM-BAAWF	■	△	□

⊕ 220÷240Vac | IP40

UP to 127 lm/W | UP to UGR≥16 | L80/B20 80.000 h. | CRI>90 | UP to RG0 | SDCM<3
Lumen output values: luminaire luminous flux at 4000 K - optics 50°

Line - Dark

E

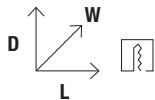
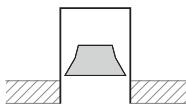

Model	Power	Hole size (mm)			Lumen output	*code to complete				
		Width	Length	Depth						
150 ∞	6 W	46	159	80	790 lm	SM-DAAYQ	■	△	●	□
300 ◇	6 W	46	279	80	760 lm	SM-DAAVQ	■	△	●	□
600	12 W	46	559	80	1518 lm	SM-DAAAA	■	△	●	□
1100	24 W	46	1119	80	3036 lm	SM-DAABC	■	△	●	□
1700	36 W	46	1679	80	4554 lm	SM-DAACD	■	△	●	□
2200	48 W	46	2239	80	6072 lm	SM-DAADE	■	△	●	□
2800	60 W	46	2799	80	7590 lm	SM-DAAWF	■	△	●	□

⊕ 220÷240Vac | IP40

UP to 127 lm/W | UP to UGR≥16 | L80/B20 80.000 h. | CRI>90 | UP to RG0 | SDCM<3
Lumen output values: luminaire luminous flux at 4000 K - optics 50°

Optical Info p. 528

* Select your option

CCT	Optic	Colour	Control	#
2700 K	120°	White	On/Off	Only: 120° - DALI(DT8), Casambi
3000 K	Micro	Black	DALI	** Only: 1700 - 2200 - 2800
4000 K	50° White		Em. 1h **	*** Configurations up to max 2mt. length
Tunable #	50° Black		Casambi	∞ Only: Stand Alone / no Asy Optic
	80° White		Push ***	◇ Stand Alone only
	80° Black			
	Asy White			
	Asy Black			

Blind Line - Filo

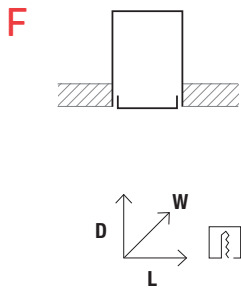

Model	Hole size (mm)			*code to complete
	Width	Length	Depth	
600	46	559	80	SM-BAEA ●
1100	46	1119	80	SM-BAEB ●
1700	46	1679	80	SM-BAEC ●
2200	46	2239	80	SM-BAED ●

Blind Line - Dark

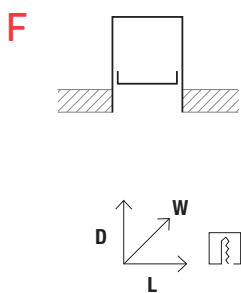

Model	Hole size (mm)			*code to complete
	Width	Length	Depth	
600	46	559	80	SM-DAEA ●
1100	46	1119	80	SM-DAEB ●
1700	46	1679	80	SM-DAEC ●
2200	46	2239	80	SM-DAED ●

Accessories

	Description	code to complete
D	Safety cable (2x)	CSS05300
	Fixing Clip (2x 300, 600, 1100 - 3x 1700, 2200, 2800)	CSS07206
	End Cap (2x)	CS ▼ 07203

Joint

C	Metal connection	CSS07304
----------	------------------	-----------------

* Select your option

Colour	End Cap Colour
White W ●	White W ▼
Black B	Black B

SLIM_Semirecessed



Slim semi_incasso è parte integrante della collezione assieme alla versione track e parete. Diverse le scelte possibili all'interno della gamma: potenze di 12W, 20W, 33W; schede led con tono colore 2700, 3000 e 4000K; ottiche con diverse angolazioni unitamente ad una paletta colori allargata ampliano i valori della proposta e le possibilità d'installazione. La luce emessa si distingue per l'ottima diffusione del fascio e per l'elevata qualità cromatica (CRI > 90 / MacAdam < 3). Queste caratteristiche li rendono particolarmente adatti all'illuminazione di negozi, delle aree espositive e di tutti quegli ambienti dove la resa del colore e la pulizia dei fasci luminosi sono di primaria importanza. Le lenti ottiche intercambiabili sono di tipo semidiffusivo e l'abbagliamento diretto è totalmente controllato grazie alla profonda schermatura con un cut-off di 36° che caratterizza il frontale. Oltre alle tradizionali versioni On/Off, Slim è disponibile anche nelle versioni con alimentazione DALI e Casambi. Il driver è separato dall'apparecchio e viene inserito nel controsoffitto attraverso il foro di fissaggio.

Slim semi_incasso is an integral part of the collection, along with the track and wall versions. There are various choices available within the range: power options of 12W, 20W, 33W; LED boards with color temperatures of 2700K, 3000K, and 4000K; optics with different angles, along with an expanded color palette, enhance the proposal value and installation possibilities. The emitted light is distinguished by excellent beam diffusion and high color quality (CRI > 90 / MacAdam < 3). These features make them particularly suitable for lighting shops, exhibition areas, and all environments where color rendering and clean light beams are of primary importance. The interchangeable optical lenses are semi-diffusing, and direct glare is completely controlled thanks to the deep shielding with a 36° cut-off that characterizes the front. In addition to the traditional On/Off versions, Slim is also available in DALI and Casambi power supply options. The driver is separate from the fixture and is inserted into the false ceiling through the mounting hole.



+ SLIM GU10 Track pag 198



+ SLIM Track pag 192



EXTENDED
COLLECTION



+ SLIM GU10 Ceiling pag 251

+ SLIM Ceiling pag 248

SLIM_Semirecessed

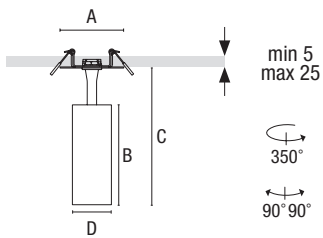

Power	Lumen output	Hole size	Product dimension				Weight	*code to complete
			A	B	C	D		
12W	1255 lm	70 mm	85 mm	134 mm	183 mm	52 mm	0,39 kg	TB-CA ⊕ ● □ :: ▼
20W	2280 lm	70 mm	85 mm	150 mm	187 mm	55 mm	0,49 kg	TB-CC ⊕ ● □ :: ▼
33W	3486 lm	70 mm	85 mm	140 mm	180 mm	72 mm	0,61 kg	TB-CE ⊕ ● □ :: ▼

□ 220÷240Vac | IP20

CRI>90 | RG1 | SDCM<3

UP to 114 lm/W | L80/B20 50.000 h.

Lumen output values: luminaire luminous flux at 4000 K - optics 38°

Optical Info p. 533

* Select your option

Colour Base	⊕	CCT	●	Optic	□	Control	::	Colour	▼
White	W	2700 K	1	15°	1	On/Off	NF	White	W
Black	B	3000 K	2	24°	2	Phase Cut **	PC	Black	B
		4000 K	3	38°	4	Push	PU	Sand	V
				55°	5	0-1/10 V	AN	Silver	G
						DALI	DA	Tobacco	O
						Casambi	CA		

** only: 12W - 20W

SLIM_GU10 Semirecessed



GU10

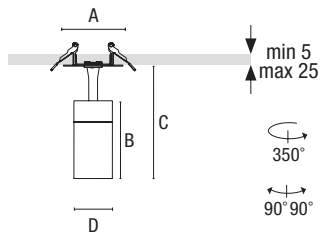

Power	Source	Hole size	Product dimension				Weight	*	code to complete
			A	B	C	D			
1x max 50W	GU10	70 mm	85 mm	110 mm	161 mm	55 mm	0,25 kg		TC-C ▼
<input type="checkbox"/> 220÷240Vac IP20									Lamp not included

* Select your option

Colour ▼

- White W
- Black B

EXTREME_Recessed

Extreme si coordina in una gamma completa che include la versione incasso insieme alle versioni binario e soffitto. Il driver viene alloggiato nel controsoffitto lasciando in vista solo il riflettore dell'apparecchio. Rimane pienamente disponibile l'orientamento sull'asse verticale ed orizzontale. Extreme semi incasso dispone di schede led con tono colore 2700K, 3000K e 4000K nonché alimentazioni On/Off e DALI. I colori dell'anello in alluminio tornito, ottenuti con trattamento speciale, qualificano gli ambienti in cui vengono installati.

Extreme is part of a complete range that includes the recessed version, along with the track and ceiling versions. The driver is housed in the false ceiling, leaving only the reflector of the fixture visible. Full orientation along the vertical and horizontal axes is maintained. Extreme semi-incasso features LED boards with color temperatures of 2700K, 3000K, and 4000K, as well as On/Off and DALI power supplies. The colors of the aluminum ring, obtained through a special treatment, distinctly enhance the environments in which they are installed.



+ EXTREME Ceiling/Wall pag 240



EXTENDED
COLLECTION



+ EXTREME Track pag 208

EXTREME_Semirecessed

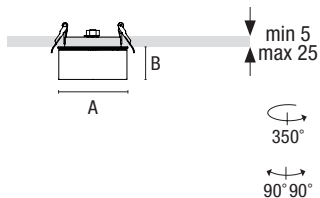

Power	Lumen output	Hole size	Product dimension		Weight	*code to complete
			A	B		
12W	1447 lm	95 mm	105 mm	47 mm	0,51 kg	TF-CA
18W	1852 lm	95 mm	105 mm	47 mm	0,51 kg	TF-CB
220÷240Vac IP20						CRI>90 RG1 SDCM<3 UP to 104 lm/W L80/B20 80.000 h. Lumen output values: luminaire luminous flux at 4000 K - optics 38°

Optical Info p. 534

*** Select your option**

Colour Base	CCT	Optic	Control	Colour Ring
White W	2700 K 1	15° 1	On/Off NF	White W
Black B	3000 K 2	24° 2	Phase Cut PC	Black B
	4000 K 3	38° 3	Push PU	Rose Gold S
		55° 4	0-1/10 V AN	Bronze Z
			DALI DA	Titanium T
			Casambi CA	Satin steel A

EXTREME_Semirecessed

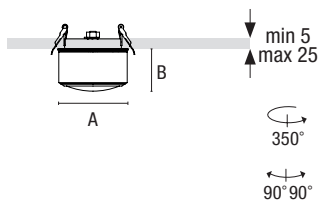

Power	Lumen output	Hole size	Product dimension		Weight	*code to complete
			A	B		
12W	1228 lm	95 mm	105 mm	60 mm	0,64 kg	TF-CA
18W	1426 lm	95 mm	105 mm	60 mm	0,64 kg	TF-CB
220÷240Vac IP20 CRI>90 RG1 SDCM<3 UP to 88 lm/W L70/B10 60.000 h. Lumen output values: luminaire luminous flux at 4000 K						

Optical Info p. 534

*** Select your option**

Colour Base	CCT	Optic	Control	Colour Ring
White W	2700 K 1	120° 5	On/Off NF	White W
Black B	3000 K 2		Phase Cut PC	Black B
	4000 K 3		Push PU	Rose Gold S
			0-1/10 V AN	Bronze Z
			DALI DA	Titanium T
			Casambi CA	Satin steel A

EXTREME_Recessed

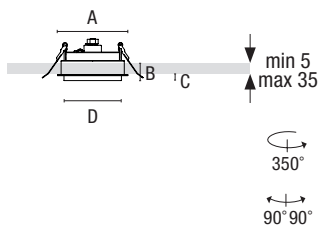

Power	Lumen output	Hole size	Product dimension				Weight	*code to complete
			A	B	C	D		
12W	1447 lm	112 mm	125 mm	32 mm	9 mm	103 mm	0,60 kg	TF-DA
18W	1852 lm	112 mm	125 mm	32 mm	9 mm	103 mm	0,60 kg	TF-DB

220÷240Vac | IP20









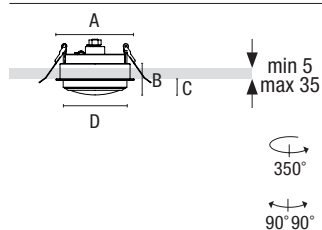

CRI>90 | RG1 | SDCM<3
UP to 104 lm/W | L80/B20 80.000 h.
Lumen output values: luminaire luminous flux at 4000 K - optics 38°

*** Select your option**

Colour Base	CCT	Optic	Control	Colour Ring
White W	2700 K 1	15° 1	On/Off NF	White W
Black B	3000 K 2	24° 2	Phase Cut PC	Black B
	4000 K 3	38° 3	Push PU	Rose Gold S
		55° 4	0-1/10 V AN	Bronze Z
			DALI DA	Titanium T
			Casambi CA	Satin steel A

EXTREME_Recessed







Power	Lumen output	Hole size	Product dimension				Weight	*code to complete
			A	B	C	D		
12W	1228 lm	112 mm	125 mm	47 mm	24 mm	103 mm	0,72 kg	TF-DA     
18W	1426 lm	112 mm	125 mm	47 mm	24 mm	103 mm	0,72 kg	TF-DB     

 220÷240Vac | IP20

CRI>90 | RG1 | SDCM<3
UP to 88 lm/W | L70/B10 60.000 h.
Lumen output values: luminaire luminous flux at 4000 K

* Select your option

Colour Base		CCT		Optic		Control		Colour Ring	
White	W	2700 K	1	120°	5	On/Off	NF	White	W
Black	B	3000 K	2			Phase Cut	PC	Black	B
		4000 K	3			Push	PU	Rose Gold	S
						0-1/10 V	AN	Bronze	Z
						DALI	DA	Titanium	T
						Casambi	CA	Satin steel	A

SINERGY_Semirecessed



Efficienza ed estetica ai massimi livelli sono i plus del proiettore SINERGY. Un design attento e minimale, in linea con le richieste del mercato, è associato a scelte tecniche di eccellenza.

L'apparecchio si pone ai vertici di categoria nel rapporto flussi luminosi e dimensioni. Perfetto controllo delle temperature, LED di eccellenza assoluta, ottiche performanti, sistemi di alimentazione e controlli evoluti, posizionano l'apparecchio nella fascia alta delle scelte progettuali. SINERGY, frutto di un concreto lavoro di ricerca e sviluppo, si candida all'impiego nelle installazioni più prestigiose attente al mix tra valore estetico ed efficientamento energetico.

Efficiency and aesthetics at the highest levels are the strengths of the SINERGY projector. A thoughtful and minimal design, in line with market demands, is combined with excellent technical choices. The device ranks at the top of its category in terms of luminous output and dimensions. Perfect temperature control, top-notch LEDs, high-performance optics, advanced power systems, and controls position the device in the high-end range of design choices. SINERGY, the result of concrete research and development, is suitable for use in the most prestigious installations that prioritize the blend of aesthetic value and energy efficiency.





EXTENDED COLLECTION



SINERGY_Semirecessed

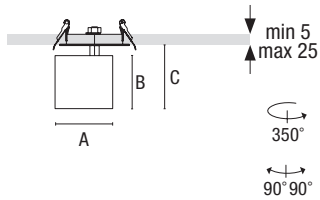

Power	Lumen output	Hole size	Product dimension			Weight	* code to complete
			A	B	C		
18W	1967 lm	95 mm	87mm	80mm	97mm	0,60 kg	TE-CB ● □ ∴ ⊕ ▼
28W	3060 lm	95 mm	87mm	80mm	97mm	0,60 kg	TE-CD ● □ ∴ ⊕ ▼

□ 220÷240Vac | IP20

CRI>90 | RG1 | SDCM<3

UP to 109 lm/W | L80/B20 80.000 h.

Lumen output values: luminaire luminous flux at 4000 K - optics 38°

Accessories

	Description	Weight	18W	28W
	Honeycomb grid	0,02 kg	RTL28016	RTL28016

Optical Info p. 534

* Select your option

CCT	●	Optic	□	Control	∴	Colour Base	⊕	Colour	▼
2700 K	1	15°	1	On/Off	NF	White	W	White	W
3000 K	2	24°	2	Phase Cut	PC	Black	B	Black	B
4000 K	3	38°	3	Push	PU				
		65°	6	0-1/10 V	AN				
				DALI	DA				
				Casambi	CA				



NEMO

Un programma completo ideale supporto per ogni necessità illuminotecnica. Retail, Show room, Residential, Hospitality, Office, General lighting: le nostre soluzioni risolvono brillantemente ogni impiego garantendo alti standard qualitativi. Efficienze elevate con emissioni da 500 a 3500 lm. Installazioni fisse, orientabili, con basso indice UGR, trimless, IP 54; ampio range di temperature di colore: 2700K - 3000K - 4000K, tunable white. Piani ottici differenziati secondo specifici utilizzi, scelte estetiche variabili per colori e modelli. Le principali gestioni elettroniche completano la proposta.

A full range of products ideal for every lighting need. Retail, Show room, Residential, Hospitality, Office, General lighting: Nemo range can offer high colour quality (CRI>92) and Prime brand LED. Emissions from 500 to 3500 lm. Fixed installations, adjustable, low UGR index, trimless, IP54. Wide range of colour temperatures: 2700K - 3000K - 4000K and tunable white. Different Optical planes according to specific uses, variable aesthetic choices thanks to a wide range of colors and models. The main electronic managements complete our proposal.



Ampia la gamma per aspetto estetico o tecnico. La sezione "RING" ha bordo a vista. "SIMPLE" ha un bordo rastremato e permette installazioni semplificate, quasi invisibili su cartongesso. L'effetto finale è molto simile alle soluzioni trimless. La serie "EYE" offre un elevato comfort visivo. Diverse le configurazioni per lampada GU10. Non mancano versioni con grado di protezione IP54.

Our Nemo offer has been extended and provide a complete lighting solution for designers and lighting specialists. "RING" range present the visible edge, "SIMPLE" have a simplified edge almost invisible on plasterboard installation. The final effect is very close to trimless solutions. The "EYE" offer high visual comfort. Also available GU10 models as well as IP54 versions.



NEMO_RING

TRIMMED



Round



Adj



Fix



Comfort



Square - Round



Adj



Fix



Comfort



Square - Square



Adj



Fix



Comfort



2 Lights



Adj



Fix



Comfort



3 Lights



Adj



Fix



Comfort



CONFIGURATOR

TRIMLESS



Round



Adj



Fix



Comfort



Square - Round



Adj



Fix



Comfort



Square - Square



Adj



Fix



Comfort



2 Lights



Adj



Fix



Comfort



3 Lights



Adj



Fix

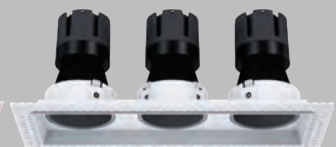

Comfort

NEMO_Ring

Trimmed_Adj-Fix

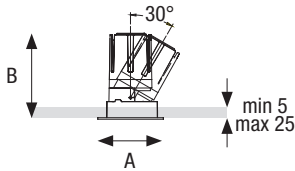
○ Round

Power	Lumen output	Hole size	Product dimension		Weight	*code to complete
			A	B		
6 W	525 lm	55 mm	62 mm	81 mm	0,14 kg	IA-ABAA ■ ▲ ● □ ▼ ⋮
10 W	1075 lm	75 mm	85 mm	89 mm	0,24 kg	IA-ABAB ■ ▲ ● □ ▼ ⋮
15 W	1510 lm	75 mm	85 mm	112 mm	0,30 kg	IA-ABBC ■ ▲ ● □ ▼ ⋮
24 W	2475 lm	100 mm	112 mm	140 mm	0,55 kg	IA-ACCD ■ ▲ ● □ ▼ ⋮
33 W	3440 lm	125 mm	140 mm	169 mm	0,95 kg	IA-ACDE ■ ▲ ● □ ▼ ⋮
42 W	4275 lm	150 mm	165 mm	184 mm	1,32 kg	IA-ADEF ■ ▲ ● □ ▼ ⋮

□ 220÷240Vac | IP40down - IP20up

UP to 100 lm/W | UP to UGR<17 | L80/B20 50.000 h. | CRI>90 | RG1 | SDCM<3
Lumen output values: luminaire luminous flux at 4000 K - optics 24°

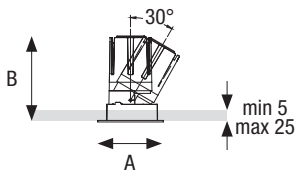
◐ Square Round

Power	Lumen output	Hole size	Product dimension		Weight	*code to complete
			A	B		
10 W	1075 lm	92 mm	102 mm	104 mm	0,29 kg	IA-BBAB ■ ▲ ● □ ▼ ⋮
15 W	1510 lm	92 mm	102 mm	127 mm	0,35 kg	IA-BBBC ■ ▲ ● □ ▼ ⋮
24 W	2475 lm	125 mm	135 mm	161 mm	0,64 kg	IA-BCCD ■ ▲ ● □ ▼ ⋮
33 W	3440 lm	155 mm	165 mm	194 mm	1,10 kg	IA-BDDE ■ ▲ ● □ ▼ ⋮

□ 220÷240Vac | IP40down - IP20up

UP to 100 lm/W | UP to UGR<17 | L80/B20 50.000 h. | CRI>90 | RG1 | SDCM<3
Lumen output values: luminaire luminous flux at 4000 K - optics 24°

Accessories

Description	Minimum Recessing hole	IP	Weight	Code					
				6W	10W	15W	24W	33W	42W
Emergency kit 1 Hour	75 mm	IP20	0,43 kg	/	DRV9092	DRV9092	DRV9092	DRV9092	DRV9092
Emergency kit 3 Hours	100 mm	IP20	0,88 kg	/	/	/	DRV9091	DRV9091	DRV9091
Honeycomb grid			0,02 kg	RTL28011	RTL28012	RTL28012	RTL28013	RTL28014	RTL28015

Optical Info p. 529

* Select your option

Version	Ring color	CCT	Optic	Reflector color	Control
Fix	White	2700 K	8°	Matt	On/Off
Adj	Black	3000 K	15°	Mirror	Phase Cut/IGBT-TRIAC
		4000 K	24°	Titanium	Push
		Tunable # ** ** *	38°	Gold	0-1/10 V
			55° **	White	DALI **
				Matt Bronze	Casambi **
				Red	
				Yellow	

** No: 6W

*** No: 42W

Only: DALI (DT8), Casambi

• only: 10W - 15W

NEMO_Ring

Trimmed_Comfort



Round

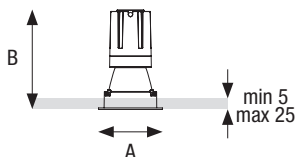

Power	Lumen output	Hole size	Product dimension		Weight	*code to complete
			A	B		
10 W	990 lm	75 mm	85 mm	107 mm	0,20 kg	IA-ABAB ■ △ ● □ ▼ ::
15 W	1390 lm	75 mm	85 mm	130 mm	0,27 kg	IA-ABBC ■ △ ● □ ▼ ::
24 W	2280 lm	100 mm	112 mm	165 mm	0,47 kg	IA-ACCD ■ △ ● □ ▼ ::
33 W	3165 lm	125 mm	140 mm	200 mm	0,83 kg	IA-ACDE ■ △ ● □ ▼ ::
42 W	3930 lm	150 mm	165 mm	229 mm	1,13 kg	IA-ADEF ■ △ ● □ ▼ ::

□ 220÷240Vac | IP40down - IP20up

UP to 100 lm/W | UP to UGR<17 | L80/B20 50.000 h. | CRI>90 | RG1 | SDCM<3
Lumen output values: luminaire luminous flux at 4000 K - optics 24°

Square Round

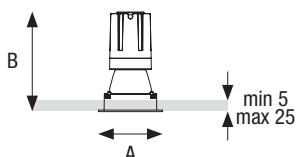

Power	Lumen output	Hole size	Product dimension		Weight	*code to complete
			A	B		
10 W	990 lm	92 mm	102 mm	120 mm	0,25 kg	IA-BBAB ■ △ ● □ ▼ ::
15 W	1390 lm	92 mm	102 mm	147 mm	0,32 kg	IA-BBBC ■ △ ● □ ▼ ::
24 W	2280 lm	125 mm	135 mm	185 mm	0,55 kg	IA-BCCD ■ △ ● □ ▼ ::
33 W	3165 lm	155 mm	165 mm	230 mm	0,98 kg	IA-BDDE ■ △ ● □ ▼ ::

□ 220÷240Vac | IP40down - IP20up

UP to 100 lm/W | UP to UGR<17 | L80/B20 50.000 h. | CRI>90 | RG1 | SDCM<3 Valori
Lumen output values: luminaire luminous flux at 4000 K - optics 24°

Accessories

Description	Minimum Recessing hole	IP	Weight	Code					
				/	10W	15W	24W	33W	42W
Emergency kit 1 Hour	75 mm	IP20	0,43 kg	/	DRV9092	DRV9092	DRV9092	DRV9092	DRV9092
Emergency kit 3 Hours	100 mm	IP20	0,88 kg	/	/	/	DRV9091	DRV9091	DRV9091
Honeycomb grid			0,02 kg	/	RTL28012	RTL28012	RTL28013	RTL28014	RTL28015

Optical Info p. 529

* Select your option

Version	Ring color	CCT	Optic	Reflector color	Control		
Comfort C	White W	2700 K	1	8°	5	White E	On/Off NF
		3000 K	2	15°	1	Matt Silver F	Phase Cut/IGBT-TRIAC • PC
	4000 K	3	24°	2	Matt Black G	Push PU	
	Black B	38°	3	Matt Bronze H	0-1/10 V AN		
		55°	4	Red I	DALI DA		
			Yellow L	Casambi CA			

*** No: 42W

Only: DALI (DT8), Casambi

• only: 10W - 15W

Trimmed_Comfort

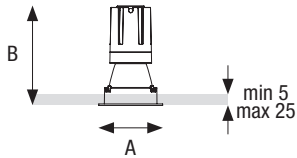
 Square Square

Power	Lumen output	Hole size	Product dimension		Weight	*code to complete
			A	B		
10 W	990 lm	75 mm	85 mm	107 mm	0,21 kg	IA-EBAB ■ △ ● □ ▼ ⋮
15 W	1390 lm	75 mm	85 mm	130 mm	0,27 kg	IA-EBBC ■ △ ● □ ▼ ⋮
24 W	2280 lm	100 mm	112 mm	165 mm	0,49 kg	IA-ECCD ■ △ ● □ ▼ ⋮
33 W	3165 lm	125 mm	140 mm	200 mm	0,87 kg	IA-ECDE ■ △ ● □ ▼ ⋮
42 W	3930 lm	150 mm	165 mm	229 mm	1,14 kg	IA-EDEF ■ △ ● □ ▼ ⋮

□ 220÷240Vac | IP40down - IP20up

UP to 100 lm/W | UP to UGR<17 | L80/B20 50.000 h. | CRI>90 | RG1 | SDCM<3
Lumen output values: luminaire luminous flux at 4000 K - optics 24°

Accessories

Description	Minimum Recessing hole	IP	Weight	Code					
				/	10W	15W	24W	33W	42W
Emergency kit 1 Hour	75 mm	IP20	0,43 kg	/	DRV9092	DRV9092	DRV9092	DRV9092	DRV9092
Emergency kit 3 Hours	100 mm	IP20	0,88 kg	/	/	/	DRV9091	DRV9091	DRV9091
Honeycomb grid				/	RTL28012	RTL28012	RTL28013	RTL28014	RTL28015

Optical Info p. 529

* Select your option

Version	Ring color	CCT	Optic	Reflector color	Control
Comfort	White Black	2700 K 3000 K 4000 K Tunable *** #	8° 15° 24° 38° 55°	White Matt Silver Matt Black Matt Bronze Red Yellow	On/Off Phase Cut/IGBT-TRIAC Push 0-1/10 V DALI Casambi
	W B	1 2 3 4	5 1 2 3 4	E F G H I L	NF PC PU AN DA CA

*** No: 42W

Only: DALI (DT8), Casambi

• only: 10W - 15W



HIGH
VISUAL
COMFORT

NEMO_Ring

Trimmed_Adj-Fix



2 Lights

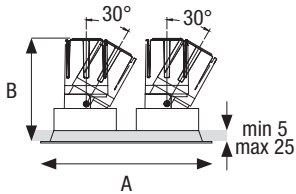

Power	Lumen output	Hole size	Product dimension		Weight	*code to complete
			A	B		
2x 10 W	2150 lm	92x180 mm	102x192 mm	104 mm	0,54 kg	IA-CDCG ■ ▲ ● □ ▼ ☺☺
2x 15 W	3020 lm	92x180 mm	102x192 mm	127 mm	0,67 kg	IA-CDDI ■ ▲ ● □ ▼ ☺☺

☐ 220÷240Vac | IP40down - IP20up UP to 100 lm/W | UP to UGR<17 | L80/B20 50.000 h. | CRI>90 | RG1 | SDCM<3
Lumen output values: luminaire luminous flux at 4000 K - optics 24°

3 Lights

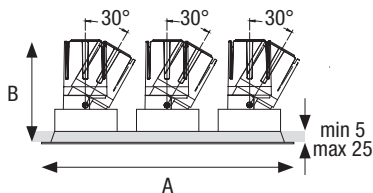

Power	Lumen output	Hole size	Product dimension		Weight	*code to complete
			A	B		
3x 10 W	3230 lm	92x270 mm	102x282 mm	104 mm	0,79 kg	IA-DEDH ■ ▲ ● □ ▼ ☺☺
3x 15 W	4525 lm	92x270 mm	102x282 mm	127 mm	0,98 kg	IA-DEEL ■ ▲ ● □ ▼ ☺☺

☐ 220÷240Vac | IP40down - IP20up UP to 100 lm/W | UP to UGR<17 | L80/B20 50.000 h. | CRI>90 | RG1 | SDCM<3
Lumen output values: luminaire luminous flux at 4000 K - optics 24°

Accessories

Description	Minimum Recessing hole	IP	Weight	Code					
				/	10W	15W	/	/	/
Emergency kit 1 Hour	75 mm	IP20	0,43 kg	/	DRV9092	DRV9092	/	/	/
Emergency kit 3 Hours	100 mm	IP20	0,88 kg	/	/	/	/	/	/
Honeycomb grid			0,02 kg	/	RTL28012	RTL28012	/	/	/

Il numero di accessori varia in base al numero di moduli luminosi.
The number of accessories to be ordered varies according to the number of light modules.

Optical Info p. 529

* Select your option

Version	■	Ring color	▲	CCT	●	Optic	□	Reflector color	▼	Control	☺☺
Fix	A	White	W	2700 K	1	8°	5	Matt	A	On/Off	NF
Adj	B	Black	B	3000 K	2	15°	1	Mirror	B	Phase Cut/IGBT-TRIAC	PC
				4000 K	3	24°	2	Titanium	C	Push	PU
				Tunable #	4	38°	3	Gold	D	0-1/10 V	AN
						55°	4	White	E	DALI	DA
								Matt Bronze	H	Casambi	CA
								Red	I		
								Yellow	L		

Only: DALI (DT8), Casambi

NEMO_Ring

Trimmed_Comfort

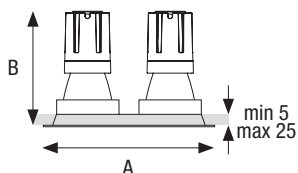
 2 Lights

Power	Lumen output	Hole size	Product dimension		Weight	* code to complete
			A	B		
2x 10 W	1980 lm	92x180 mm	102x192 mm	120 mm	0,47 kg	IA-CDCG ■ ▲ ● □ ▼ ⋮
2x 15 W	2775 lm	92x180 mm	102x192 mm	147 mm	0,60 kg	IA-CDDI ■ ▲ ● □ ▼ ⋮

☐ 220÷240Vac | IP40down - IP20up UP to 100 lm/W | UP to UGR<17 | L80/B20 50.000 h. | CRI>90 | RG1 | SDCM<3
Lumen output values: luminaire luminous flux at 4000 K - optics 24°

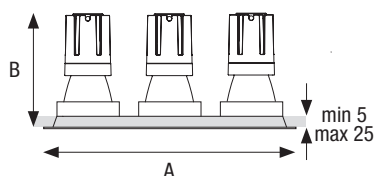
 3 Lights

Power	Lumen output	Hole size	Product dimension		Weight	* code to complete
			A	B		
3x 10 W	2970 lm	92x270 mm	102x282 mm	120 mm	0,69 kg	IA-DEDH ■ ▲ ● □ ▼ ⋮
3x 15 W	4165 lm	92x270 mm	102x282 mm	147 mm	0,88 kg	IA-DEEL ■ ▲ ● □ ▼ ⋮

☐ 220÷240Vac | IP40down - IP20up UP to 100 lm/W | UP to UGR<17 | L80/B20 50.000 h. | CRI>90 | RG1 | SDCM<3
Lumen output values: luminaire luminous flux at 4000 K - optics 24°

Accessories

Description	Minimum Recessing hole	IP	Weight	Code					
				/	10W	15W	/	/	/
Emergency kit 1 Hour	75 mm	IP20	0,43 kg	/	DRV9092	DRV9092	/	/	/
Emergency kit 3 Hours	100 mm	IP20	0,88 kg	/	/	/	/	/	/
Honeycomb grid			0,02 kg	/	RTL28012	RTL28012	/	/	/

Il numero di accessori varia in base al numero di moduli luminosi.
The number of accessories to be ordered varies according to the number of light modules.

Optical Info p. 529

* Select your option

Version	Ring color	CCT	Optic	Reflector color	Control
Comfort	White	2700 K	8°	White	On/Off
		3000 K	15°	Matt Silver	Phase Cut/IGBT-TRIAC
	4000 K	24°	Matt Black	Push	
	Tunable #	38°	Matt Bronze	0-1/10 V	
		55°	Red	DALI	
			Yellow	Casambi	

Only: DALI (DT8), Casambi

NEMO_Ring

Trimless_Adj-Fix

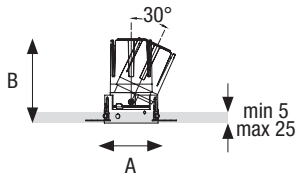
 Round

Power	Lumen output	Hole size	Product dimension		Weight	* code to complete
			A	B		
6 W	525 lm	55 mm	85 mm	81 mm	0,14 kg	IB-ABAA ■ △ ● □ ▼ ⋮
10 W	1075 lm	75 mm	110 mm	89 mm	0,24 kg	IB-ABAB ■ △ ● □ ▼ ⋮
15 W	1510 lm	75 mm	110 mm	112 mm	0,31 kg	IB-ABBC ■ △ ● □ ▼ ⋮
24 W	2475 lm	100 mm	150 mm	140 mm	0,55 kg	IB-ACCD ■ △ ● □ ▼ ⋮
33 W	3440 lm	125 mm	202 mm	169 mm	0,97 kg	IB-ACDE ■ △ ● □ ▼ ⋮
42 W	4275 lm	150 mm	232 mm	184 mm	1,32 kg	IB-ADEF ■ △ ● □ ▼ ⋮

□ 220÷240Vac | IP40down - IP20up

UP to 100 lm/W | UP to UGR<17 | L80/B20 50.000 h. | CRI>90 | RG1 | SDCM<3
Lumen output values: luminaire luminous flux at 4000 K - optics 24°

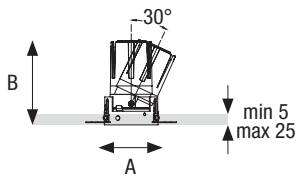
 Square

Power	Lumen output	Hole size	Product dimension		Weight	* code to complete
			A	B		
10 W	1075 lm	85 mm	120 mm	104 mm	0,28 kg	IB-BBAB ■ △ ● □ ▼ ⋮
15 W	1510 lm	85 mm	120 mm	127 mm	0,34 kg	IB-BBBC ■ △ ● □ ▼ ⋮

□ 220÷240Vac | IP40down - IP20up

UP to 100 lm/W | UP to UGR<17 | L80/B20 50.000 h. | CRI>90 | RG1 | SDCM<3
Lumen output values: luminaire luminous flux at 4000 K - optics 24°

Accessories

Description	Minimum	IP	Weight	Code						
				Recessing hole	6W	10W	15W	24W	33W	42W
Emergency kit 1 Hour	75 mm	IP20	0,43 kg	/	DRV9092	DRV9092	DRV9092	DRV9092	DRV9092	DRV9092
Emergency kit 3 Hours	100 mm	IP20	0,88 kg	/	/	/	DRV9091	DRV9091	DRV9091	DRV9091
Honeycomb grid			0,02 kg	RTL28011	RTL28012	RTL28012	RTL28013	RTL28014	RTL28015	RTL28015

Optical Info p. 529

* Select your option

Version	Ring color	CCT	Optic	Reflector color	Control
Fix	White	2700 K	8° *	Matt	On/Off
Adj		3000 K	15°	Mirror	Phase Cut/IGBT-TRIAC*
		4000 K	24°	Titanium	Push
		Tunable # ** ***	38°	Gold	0-1/10 V
			55° **	White	DALI **
				Matt Bronze	Casambi **
				Red	
				Yellow	

** No: 6W

*** No: 42W

Only: DALI (DT8), Casambi

• only: 10W - 15W

NEMO_Ring

Trimless_Comfort

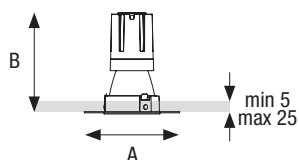
○ Round

Power	Lumen output	Hole size	Product dimension		Weight	*code to complete
			A	B		
10 W	990 lm	75 mm	110 mm	107 mm	0,21 kg	IB-ABAB ■ ▲ ● □ ▼ ❖
15 W	1390 lm	75 mm	110 mm	130 mm	0,28 kg	IB-ABBC ■ ▲ ● □ ▼ ❖
24 W	2280 lm	100 mm	150 mm	165 mm	0,47 kg	IB-ACCD ■ ▲ ● □ ▼ ❖
33 W	3165 lm	125 mm	202 mm	200 mm	0,85 kg	IB-ACDE ■ ▲ ● □ ▼ ❖
42 W	3930 lm	150 mm	232 mm	229 mm	1,14 kg	IB-ADEF ■ ▲ ● □ ▼ ❖

☑ 220÷240Vac | IP40down - IP20up

UP to 100 lm/W | UP to UGR<17 | L80/B20 50.000 h. | CRI>90 | RG1 | SDCM<3
Lumen output values: luminaire luminous flux at 4000 K - optics 24°

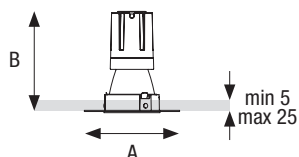
◼ Square

Power	Lumen output	Hole size	Product dimension		Weight	*code to complete
			A	B		
10 W	990 lm	85 mm	120 mm	128 mm	0,24 kg	IB-BBAB ■ ▲ ● □ ▼ ❖
15 W	1390 lm	85 mm	120 mm	150 mm	0,31 kg	IB-BBBC ■ ▲ ● □ ▼ ❖

☑ 220÷240Vac | IP40down - IP20up

UP to 100 lm/W | UP to UGR<17 | L80/B20 50.000 h. | CRI>90 | RG1 | SDCM<3
Lumen output values: luminaire luminous flux at 4000 K - optics 24°

Accessories

Description	Minimum Recessing hole	IP	Weight	Code					
				/	10W	15W	24W	33W	42W
Emergency kit 1 Hour	75 mm	IP20	0,43 kg	/	DRV9092	DRV9092	DRV9092	DRV9092	DRV9092
Emergency kit 3 Hours	100 mm	IP20	0,88 kg	/	/	/	DRV9091	DRV9091	DRV9091
Honeycomb grid			0,02 kg	/	RTL28012	RTL28012	RTL28013	RTL28014	RTL28015

Optical Info p. 529

* Select your option

Version	Ring color	CCT	Optic	Reflector color	Control
Comfort	White	2700 K	8°	White	On/Off
		3000 K	15°	Matt Silver	Phase Cut/IGBT-TRIAC*
		4000 K	24°	Matt Black	Push
		Tunable # ***	38°	Matt Bronze	0-1/10 V
			55°	Red	DALI
				Yellow	Casambi

*** No: 42W

Only: DALI (DT8), Casambi

*only: 10W - 15W

Trimless_Adj-Fix



●● 2 Lights

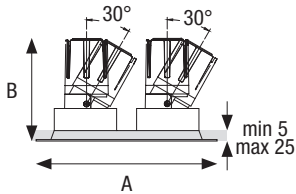

Power	Lumen output	Hole size	Product dimension		Weight	*code to complete
			A	B		
2x 10 W	2150 lm	90x180 mm	120x210 mm	104 mm	0,53 kg	IB-CDCG ■ ▲ ● □ ▼ ⚡
2x 15 W	3020 lm	90x180 mm	120x210 mm	127 mm	0,66 kg	IB-CDDI ■ ▲ ● □ ▼ ⚡

☐ 220÷240Vac | IP40down - IP20up UP to 100 lm/W | UP to UGR<17 | L80/B20 50.000 h. | CRI>90 | RG1 | SDCM<3
Lumen output values: luminaire luminous flux at 4000 K - optics 24°

●●● 3 Lights

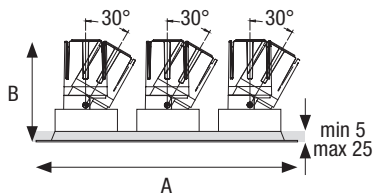

Power	Lumen output	Hole size	Product dimension		Weight	*code to complete
			A	B		
3x 10 W	3230 lm	90x270 mm	120x300 mm	104 mm	0,78 kg	IB-DEDH ■ ▲ ● □ ▼ ⚡
3x 15 W	4525 lm	90x270 mm	120x300 mm	127 mm	0,98 kg	IB-DEEL ■ ▲ ● □ ▼ ⚡

☐ 220÷240Vac | IP40down - IP20up UP to 100 lm/W | UP to UGR<17 | L80/B20 50.000 h. | CRI>90 | RG1 | SDCM<3
Lumen output values: luminaire luminous flux at 4000 K - optics 24°

Accessories

Description	Minimum Recessing hole	IP	Weight	Code				
				10W	15W	/	/	/
Emergency kit 1 Hour	75 mm	IP20	0,43 kg	DRV9092	DRV9092	/	/	/
Emergency kit 3 Hours	100 mm	IP20	0,88 kg	/	/	/	/	/
Honeycomb grid			0,02 kg	RTL28012	RTL28012	/	/	/

Il numero di accessori varia in base al numero di moduli luminosi.
The number of accessories to be ordered varies according to the number of light modules.

Optical Info p. 529

* Select your option

Version	Ring color	CCT	Optic	Reflector color	Control
Fix	White	2700 K	8°	Matt	On/Off
Adj		3000 K	15°	Mirror	Phase Cut/IGBT-TRIAC
		4000 K	24°	Titanium	Push
		Tunable #	38°	Gold	0-1/10 V
			55°	White	DALI
				Matt Bronze	Casambi
				Red	
				Yellow	

Only: DALI (DT8), Casambi

NEMO_Ring

Trimless_Comfort

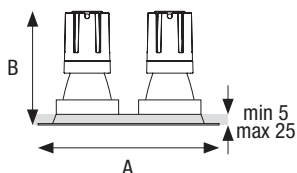
 2 Lights

Power	Lumen output	Hole size	Product dimension		Weight	*code to complete
			A	B		
2x 10 W	1980 lm	90x180 mm	120x210 mm	128 mm	0,46 kg	IB-CDCG ■ ▲ ● □ ▼ ::
3x 15 W	2775 lm	90x180 mm	120x210 mm	150 mm	0,59 kg	IB-CDDI ■ ▲ ● □ ▼ ::

□ 220÷240Vac | IP40down - IP20up UP to 100 lm/W | UP to UGR<17 | L80/B20 50.000 h. | CRI>90 | RG1 | SDCM<3
Lumen output values: luminaire luminous flux at 4000 K - optics 24°

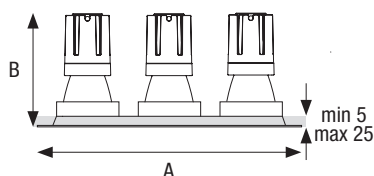
 3 Lights

Power	Lumen output	Hole size	Product dimension		Weight	*code to complete
			A	B		
3x 10 W	2970 lm	90x270 mm	120x300 mm	128 mm	0,68 kg	IB-DEDH ■ ▲ ● □ ▼ ::
3x 15 W	4165 lm	90x270 mm	120x300 mm	150 mm	0,88 kg	IB-DEEL ■ ▲ ● □ ▼ ::

□ 220÷240Vac | IP40down - IP20up UP to 100 lm/W | UP to UGR<17 | L80/B20 50.000 h. | CRI>90 | RG1 | SDCM<3
Lumen output values: luminaire luminous flux at 4000 K - optics 24°

Accessories

Description	Minimum Recessing hole	IP	Weight	Code					
				/	10W	15W	/	/	/
Emergency kit 1 Hour	75 mm	IP20	0,43 kg	/	DRV9092	DRV9092	/	/	/
Emergency kit 3 Hours	100 mm	IP20	0,88 kg	/	/	/	/	/	/
Honeycomb grid			0,02 kg	/	RTL28012	RTL28012	/	/	/

Il numero di accessori varia in base al numero di moduli luminosi.
The number of accessories to be ordered varies according to the number of light modules.

Optical Info p. 529

* Select your option

Version	Ring color	CCT	Optic	Reflector color	Control
Comfort	White	2700 K	8°	White	On/Off
		3000 K	15°	Matt Silver	Phase Cut/IGBT-TRIAC
		4000 K	24°	Matt Black	Push
		Tunable #	38°	Matt Bronze	0-1/10 V
			55°	Red	DALI
				Yellow	Casambi

Only: DALI (DT8), Casambi

NEMO

GU10



NEMO_GU10



CONFIGURATOR

TRIMMED

TRIMLESS



Round



Adj



Fix



Adj



Fix



Square - Round



Adj



Fix



Adj



Fix



2 Lights



Adj



Fix



Adj



Fix



3 Lights



Adj



Fix



Adj



Fix

NEMO_GU10

Trimmed_Adj-Fix



○ Round

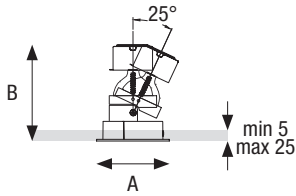

Power	Socket	Hole size	Product dimension		Weight	*code to complete
			A	B		
max 7W	GU10	75 mm	85 mm	104 mm	0,18 kg	OA-AB ■ ▲ ▼
☑ 220÷240Vac IP20						Lamp not included

◼ Square

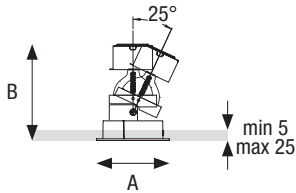

Power	Socket	Hole size	Product dimension		Weight	*code to complete
			A	B		
max 7W	GU10	92 mm	102x102 mm	118 mm	0,24 kg	OA-BB ■ ▲ ▼
☑ 220÷240Vac IP20						Lamp not included

Optical Info p. 529

* Select your option

Version	Ring color	Reflector color
Fix	White	Matt
Adj	Black	Mirror
		Titanium
		Gold
		White
		Matt Bronze
		Red
		Yellow

NEMO_GU10

Trimmed_Adj-Fix

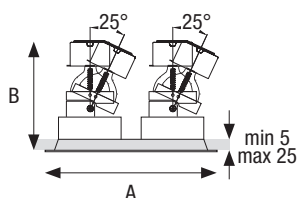
 2 Lights

Power	Socket	Hole size	Product dimension		Weight	*code to complete
			A	B		
2x max 7W	GU10	92x180 mm	102x192 mm	118 mm	0,43 kg	OA-CD ■ △ ▼
☑ 220÷240Vac IP20						Lamp not included

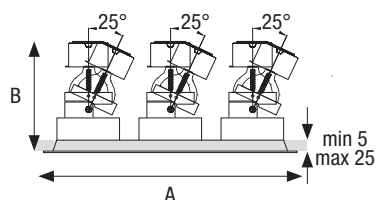
 3 Lights

Socket	Socket	Hole size	Product dimension		Weight	*code to complete
			A	B		
3x max 7W	GU10	92x270 mm	102x282 mm	118 mm	0,64 kg	OA-DE ■ △ ▼
☑ 220÷240Vac IP20						Lamp not included

Optical Info p. 529

* Select your option

Version	Ring color	Reflector color
Fix	White	Matt
Adj	Black	Mirror
		Titanium
		Gold
		White
		Matt Bronze
		Red
		Yellow

NEMO_GU10

Trimless_Adj-Fix



○ Round

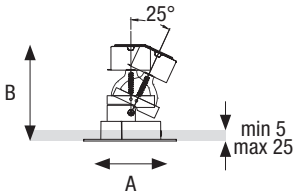

Power	Socket	Hole size	Product dimension		Weight	*code to complete
			A	B		
max 7W	GU10	75 mm	110 mm	119 mm	0,19 kg	OB-AB ■ ▲ ▼
☑ 220÷240Vac IP20						Lamp not included

◼ Square

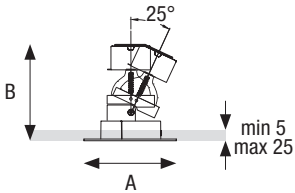

Power	Socket	Hole size	Product dimension		Weight	*code to complete
			A	B		
max 7W	GU10	85 mm	120 mm	119 mm	0,24 kg	OB-BB ■ ▲ ▼
☑ 220÷240Vac IP20						Lamp not included

Optical Info p. 529

* Select your option

Version	Ring color	Reflector color
Fix	White	Matt
Adj		Mirror
		Titanium
		Gold
		White
		Matt Bronze
		Red
		Yellow

NEMO_GU10

Trimless_Adj-Fix

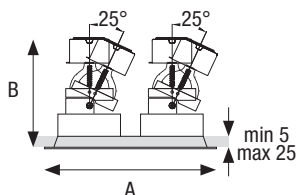
 2 Lights

Power	Socket	Hole size	Product dimension		Weight	*code to complete
			A	B		
2x max 7W	GU10	90x180 mm	120x210 mm	119 mm	0,43 kg	OB-CD ■ ▲ ▼
☐ 220÷240Vac IP20						Lamp not included

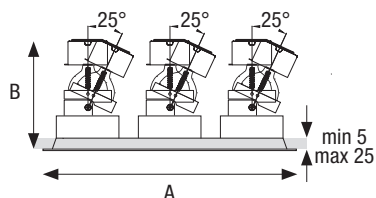
 3 Lights

Power	Socket	Hole size	Product dimension		Weight	*code to complete
			A	B		
3x max 7W	GU10	90x270 mm	120x300 mm	119 mm	0,63 kg	OB-DE ■ ▲ ▼
☐ 220÷240Vac IP20						Lamp not included

Optical Info p. 529

* Select your option

Version	■	Ring color	▲	Reflector color	▼
Fix	A	White	W	Matt	A
Adj	B			Mirror	B
				Titanium	C
				Gold	D
				White	E
				Matt Bronze	H
				Red	I
				Yellow	L

NEMO

S I M P L E



NEMO_SIMPLE



TRIMMED



Round



Asymmetric



Fix



Square - Round



Asymmetric



Fix

NEMO_Simple



Trimmed_Fix

○ Round

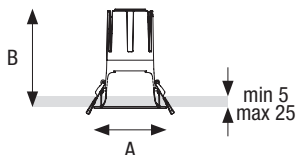

Power	Lumen output	Hole size	Product dimension		Weight	*code to complete
			A	B		
10 W	1020 lm	75 mm	84 mm	92 mm	0,21 kg	LA-ABAB ■ △ ● □ ☼
15 W	1435 lm	75 mm	84 mm	117 mm	0,28 kg	LA-ABBC ■ △ ● □ ☼
24 W	2350 lm	100 mm	110 mm	146 mm	0,49 kg	LA-ACCD ■ △ ● □ ☼
33 W	3270 lm	125 mm	138 mm	180 mm	0,87 kg	LA-ACDE ■ △ ● □ ☼
42 W	4060 lm	150 mm	164 mm	210 mm	1,23 kg	LA-ADEF ■ △ ● □ ☼

☑ 220÷240Vac | IP40down - IP20up UP to 100 lm/W | UP to UGR<17 | L80/B20 50.000 h. | CRI>90 | RG1 | SDCM<3
Lumen output values: luminaire luminous flux at 4000 K - optics 24°

◼ Square

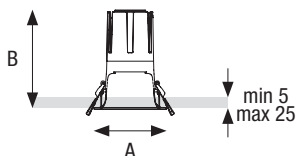

Power	Lumen output	Hole size	Product dimension		Weight	*code to complete
			A	B		
10 W	1020 lm	75 mm	88 mm	77 mm	0,23 kg	LA-BBAB ■ △ ● □ ☼
15 W	1435 lm	75 mm	88 mm	102 mm	0,30 kg	LA-BBBC ■ △ ● □ ☼

☑ 220÷240Vac | IP40down - IP20up UP to 100 lm/W | UP to UGR<17 | L80/B20 50.000 h. | CRI>90 | RG1 | SDCM<3
Lumen output values: luminaire luminous flux at 4000 K - optics 24°

Accessories

Description	Minimum Recessing hole	IP	Weight	Code					
				/	10W	15W	24W	33W	42W
Emergency kit 1 Hour	75 mm	IP20	0,43 kg	/	DRV9092	DRV9092	DRV9092	DRV9092	DRV9092
Emergency kit 3 Hours	100 mm	IP20	0,88 kg	/	/	/	DRV9091	DRV9091	DRV9091
Honeycomb grid			0,02 kg	/	RTL28012	RTL28012	RTL28013	RTL28014	RTL28015

Optical Info p. 529

* Select your option

Version	Ring color	CCT	Optic	Control
Fix	White W Black B	2700 K 1 3000 K 2 4000 K 3 Tunable # *** 4	8° • 5 15° 1 24° 2 38° 3 55° 4	On/Off NF Phase Cut/IGBT-TRIAC* PC Push PU 0-1/10 V AN DALI DA Casambi CA

*** No: 42W

Only: DALI (DT8), Casambi

• only: 10W - 15W

NEMO_Simple

Trimmed_Asymmetric



○ Round

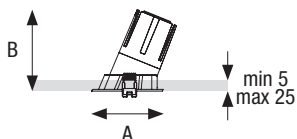

Power	Lumen output	Hole size	Product dimension		Weight	*code to complete
			A	B		
10 W	970 lm	75 mm	88 mm	92 mm	0,24 kg	LA-ABAB ■ ▲ ● □ ☼
15 W	1360 lm	75 mm	88 mm	117 mm	0,31 kg	LA-ABBC ■ ▲ ● □ ☼

☐ 220÷240Vac | IP40down - IP20up UP to 100 lm/W | UP to UGR<17 | L80/B20 50.000 h. | CRI>90 | RG1 | SDCM<3
Lumen output values: luminaire luminous flux at 4000 K - optics 24°

◻ Square

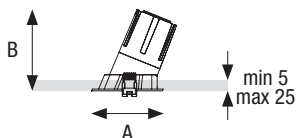

Power	Lumen output	Hole size	Product dimension		Weight	*code to complete
			A	B		
10 W	970 lm	75 mm	88 mm	80 mm	0,23 kg	LA-BBAB ■ ▲ ● □ ☼
15 W	1360 lm	75 mm	88 mm	102 mm	0,31 kg	LA-BBBC ■ ▲ ● □ ☼

☐ 220÷240Vac | IP40down - IP20up UP to 100 lm/W | UP to UGR<17 | L80/B20 50.000 h. | CRI>90 | RG1 | SDCM<3
Lumen output values: luminaire luminous flux at 4000 K - optics 24°

Accessories

Description	Minimum Recessing hole	IP	Weight	Code					
				/	10W	15W	/	/	/
Emergency kit 1 Hour	75 mm	IP20	0,43 kg	/	DRV9092	DRV9092	/	/	/
Emergency kit 3 Hours	100 mm	IP20	0,88 kg	/	/	/	/	/	/
Honeycomb grid			0,02 kg	/	RTL28012	RTL28012	/	/	/

Optical Info p. 530

* Select your option

Version	Ring color	CCT	Optic	Control
Asymmetric	White	2700 K	8°	On/Off
D	Black	3000 K	15°	Phase Cut/IGBT-TRIAC*
		4000 K	24°	Push
		Tunable #	38°	0-1/10 V
			55°	DALI
				Casambi
				NF
				PC
				PU
				AN
				DA
				CA

Only: DALI (DT8), Casambi

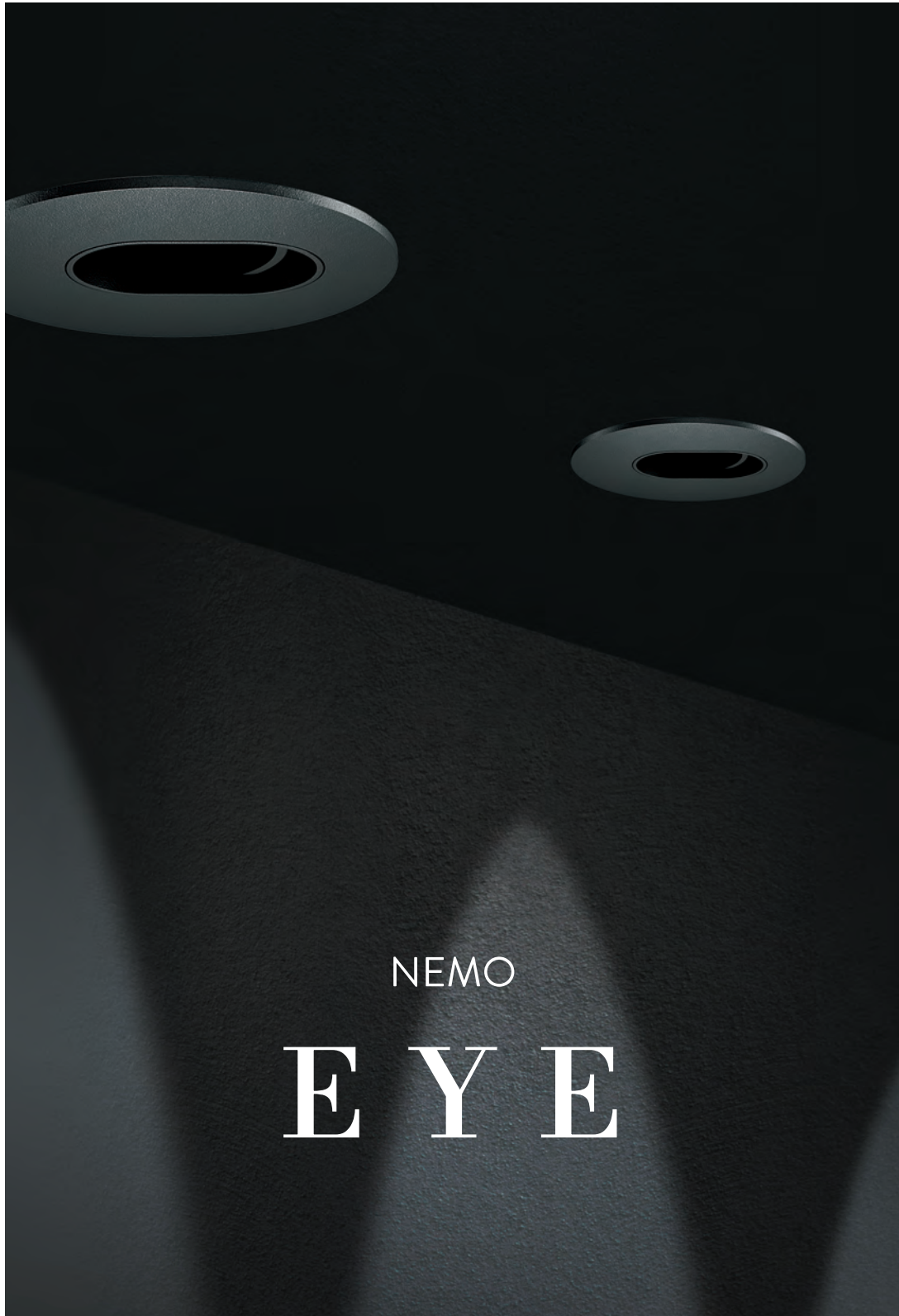

NEMO

EYE

NEMO_EYE



CONFIGURATOR

TRIMMED



Round

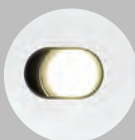

Adj



Fix



Square - Round



Adj



Fix

NEMO_Eye



Trimmed_Adj-Fix

Round

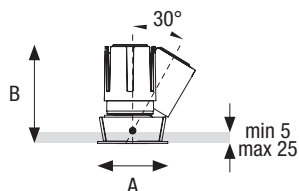

Power	Lumen output	Hole size	Product dimension		Weight	*code to complete
			A	B		
6 W	525 lm	55 mm	65 mm	80 mm	0,14 kg	MA-ABAA ■ ▲ ● □ ☼
10 W	1075 lm	65 mm	75 mm	83 mm	0,23 kg	MA-ABAB ■ ▲ ● □ ☼
15 W	1510 lm	65 mm	75 mm	106 mm	0,29 kg	MA-ABBC ■ ▲ ● □ ☼

☑ 220÷240Vac | IP40down - IP20up UP to 100 lm/W | UP to UGR<17 | L80/B20 50.000 h. | CRI>90 | RG1 | SDCM<3
Lumen output values: luminaire luminous flux at 4000 K - optics 24°

Square

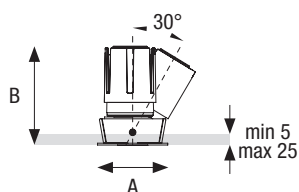

Power	Lumen output	Hole size	Product dimension		Weight	*code to complete
			A	B		
10 W	1075 lm	65 mm	75 mm	83 mm	0,23 kg	MA-BBAB ■ ▲ ● □ ☼
15 W	1510 lm	65 mm	75 mm	106 mm	0,30 kg	MA-BBBC ■ ▲ ● □ ☼

☑ 220÷240Vac | IP40down - IP20up UP to 100 lm/W | UP to UGR<17 | L80/B20 50.000 h. | CRI>90 | RG1 | SDCM<3
Lumen output values: luminaire luminous flux at 4000 K - optics 24°

Accessories

Description	Minimum Recessing hole	IP	Weight	Code			/	/	/
				6W	10W	15W			
Emergency kit 1 Hour	75 mm	IP20	0,43 kg	/	DRV9092	DRV9092	/	/	/
Emergency kit 3 Hours	100 mm	IP20	0,88 kg	/	/	/	/	/	/

Optical Info p. 530

* Select your option

Version	Ring color	CCT	Optic	Control
Fix A	White W	2700 K 1	8° 5	On/Off NF
Adj B		3000 K 2	15° 1	Phase Cut/IGBT-TRIAC* PC
		4000 K 3	24° 2	Push PU
		Tunable # ** 4	38° 3	0-1/10 V AN
			55° ** 4	DALI ** DA
				Casambi ** CA

** No: 6W

Only: DALI (DT8), Casambi

• only: 10W - 15W





NEMO_IP54



TRIMMED



Round



Fix



Square - Round



Fix

NEMO_IP54

Trimmed_Fix



○ Round

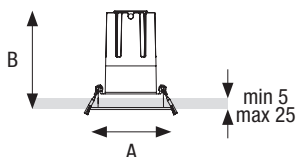

Power	Lumen output	Hole size	Product dimension		Weight	*code to complete
			A	B		
10 W	915 lm	75 mm	88 mm	85 mm	0,27 kg	NA-ABAB ■ △ ● □ ☼
15 W	1285 lm	75 mm	88 mm	108 mm	0,34 kg	NA-ABBC ■ △ ● □ ☼

☐ 220÷240Vac | IP54down - IP20up UP to 100 lm/W | UP to UGR<17 | L80/B20 50.000 h. | CRI>90 | RG1 | SDCM<3
Lumen output values: luminaire luminous flux at 4000 K - optics 24°

◻ Square

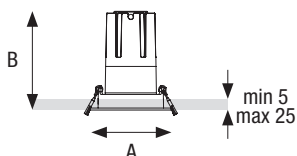

Power	Lumen output	Hole size	Product dimension		Weight	*code to complete
			A	B		
10 W	915 lm	75 mm	90 mm	70 mm	0,28 kg	NA-BBAB ■ △ ● □ ☼
15 W	1285 lm	75 mm	90 mm	95 mm	0,34 kg	NA-BBBC ■ △ ● □ ☼

☐ 220÷240Vac | IP54down - IP20up UP to 100 lm/W | UP to UGR<17 | L80/B20 50.000 h. | CRI>90 | RG1 | SDCM<3
Lumen output values: luminaire luminous flux at 4000 K - optics 24°

Accessories

Description	Minimum	IP	Weight	Code					
	Recessing hole			6W	10W	15W	/	/	/
Emergency kit 1 Hour	75 mm	IP20	0,43 kg	/	DRV9092	DRV9092	/	/	/
Emergency kit 3 Hours	100 mm	IP20	0,88 kg	/	/	/	/	/	/
Honeycomb grid			0,02 kg	/	/	/	/	/	/

Optical Info p. 529

* Select your option

Version	Ring color	CCT	Optic	Control
Fix	White	2700 K	15°	On/Off
A	W	3000 K	24°	Phase Cut/IGBT-TRIAC
		4000 K	38°	Push
		Tunable #	55°	0-1/10 V
				DALI
				Casambi

Only: DALI (DT8), Casambi



EGON



Equipaggiati con LED SMD di prima marca e con schermo diffondente, gli incassati Egon sono la soluzione ideale per ottenere effetti di luce morbida e diffusa. Grazie ad una completa gamma e al grado di protezione IP54 del vano ottico, gli incassi Egon sono ideali per l'illuminazione generale di tutti i tipi di ambiente. La serie di anelli per il retrofit li rende particolarmente indicati anche per la sostituzione dei tradizionali downlights a lampade fluorescenti compatte. Lifetime L80-B20 / 50.000 h.

Equipped with first brand SMD LEDs and with a diffusing screen, Egon recessed are the ideal solution for obtaining soft and diffused light effects. Thanks to a complete range and IP54 bottom side protection degree, Egon recessed luminaires are suitable for general lighting of all types of environments. The series of rings for the retrofit makes them particularly suitable for the replacement of traditional downlights with compact fluorescent lamps. Lifetime L80-B20 / 50.000 h.



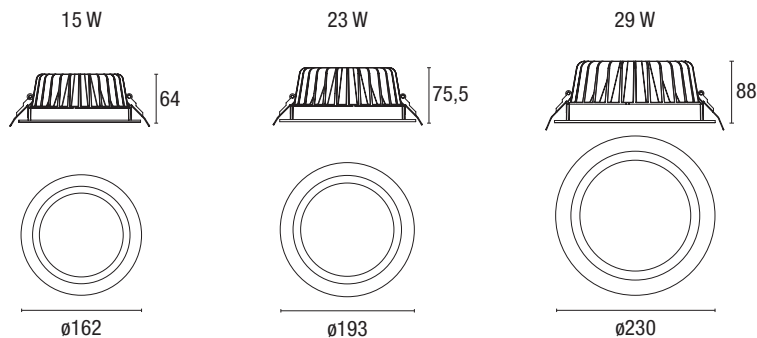

Installabili in controsoffitti di spessore compreso fra 5 mm. e 25 mm.
Models are suitable for false ceiling from 5 mm. up to 25 mm. thick.

Optical Info p. 532

Model	Hole size	Power	Code	Source	Lumen Output	CCT	Weight	Colour
On/Off	Ø 145 mm	15 W	GLT14110	SMD LED	1349 lm	3000 K	0,65 kg	White
			GLT14120	SMD LED	1410 lm	4000 K		
	Ø 165 mm	23 W	GLT14210	SMD LED	2170 lm	3000 K	0,90 kg	
			GLT14220	SMD LED	2241 lm	4000 K		
	Ø 200 mm	29 W	GLT14310	SMD LED	2619 lm	3000 K	1,25 kg	
			GLT14320	SMD LED	2713 lm	4000 K		
Push	Ø 145 mm	15 W	GLT14110DM	SMD LED	1349 lm	3000 K	0,65 kg	White
			GLT14120DM	SMD LED	1410 lm	4000 K		
	Ø 165 mm	23 W	GLT14210DM	SMD LED	2170 lm	3000 K	0,90 kg	
			GLT14220DM	SMD LED	2241 lm	4000 K		
	Ø 200 mm	29 W	GLT14310DM	SMD LED	2619 lm	3000 K	1,25 kg	
			GLT14320DM	SMD LED	2713 lm	4000 K		
DALI	Ø 145 mm	15 W	GLT14110DA	SMD LED	1349 lm	3000 K	0,65 kg	White
			GLT14120DA	SMD LED	1410 lm	4000 K		
	Ø 165 mm	23 W	GLT14210DA	SMD LED	2170 lm	3000 K	0,90 kg	
			GLT14220DA	SMD LED	2241 lm	4000 K		
	Ø 200 mm	29 W	GLT14310DA	SMD LED	2619 lm	3000 K	1,25 kg	
			GLT14320DA	SMD LED	2713 lm	4000 K		

□ 220÷240Vac | IP54

UP to 97 lm/W | UP to UGR<22 | L80/B20 50.000 h. | CRI>80 | RG1 | SDCM<3

1...10 V - Disponibile su richiesta / Dimming on demande

Emergency Kit

Operation time	Switching time	Recharging time	Minimum Recessing hole (*)	IP	Weight	Code
1 hour	0,5 sec.	24 h.	75 mm	IP20	0,43 kg	DRV9092
3 hours	0,5 sec.	24 h.	100 mm	IP20	0,88 kg	DRV9091

(*) per l'installazione in controsoffitto verificare la compatibilità con il foro di incasso; vedi dettagli a pagina 522
(*) for installation in false ceiling check the compatibility with the recessing hole; see details to page 522

Accessories

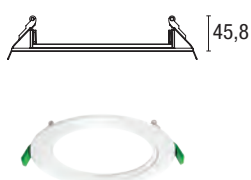
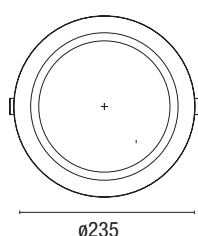

Description

Anello adattatore per retrofit: permette di installare Egon nella versione 23 W da Ø 193 mm. in un foro compreso fra Ø 195 mm e Ø 220 mm.
Retrofit adaptor ring; it allows to install Egon 23 W model Ø 193 mm. in a hole cut from Ø 195 mm. to Ø 220 mm.

18

Weight

Code

Ø195/220 mm.

0,31 kg

GLT14900

MOBY

I proiettori della serie Moby sono indicati per illuminare le aree espositive degli ambienti commerciali e dei negozi: sono equipaggiati con driver elettronici ad alta efficienza e led CoB ad alta resa cromatica (CRI > 90 e SDCM < 3) per esaltare i colori degli oggetti illuminati grazie ad una luce intensa e brillante. I gruppi ottici sono realizzati con riflettori speculari a faccette progressivamente curve e abbinati a specifiche lenti, per ottenere un elevato rendimento ottico e una perfetta diffusione della luce. I proiettori Moby offrono la possibilità di estrarre il corpo ottico oppure di arretrarlo all'interno del controsoffitto, permettendo così la massima flessibilità e orientabilità nei puntamenti. La connessione con il driver è di tipo "fast plug" e le mollette di fissaggio permettono un'installazione senza utensili.

Projectors of the Moby series are designed to illuminate the display areas of commercial environments and shops: they are equipped with high efficiency electronic drivers and high color rendering CoB LEDs (CRI > 90 and SDCM < 3) to enhance the colors of the illuminated objects thanks to an intense and bright light. The optical groups are made by combining specific lenses with mirrored reflectors with curved and progressive facets, in order to have a high optical efficiency with a perfect light diffusion.

The Moby projectors offer the possibility of extracting the optical body or moving it back into the false ceiling, thus allowing maximum flexibility and orientation in pointing. The connection with the driver is of the "fast plug" type and the fixing clips allow a tool-free installation.



Luce morbida e precisa Precise and nuanced light

Ottiche a faccette curvate progressive in abbinamento a lenti diffuse permettono di ottenere fasci di luce precisi e al tempo stesso sfumati ai bordi

Lighting effects precise and nuanced at the edge in order to light with soft shadows thanks to the diffusive lens combined with mirroring reflectors with progressive curved faceted

Doppia rotazione Double rotation

Massima orientabilità del vano ottico, con rotazione orizzontale di 350° con stop e doppia rotazione verticale, esterna fino a 45° e interna fino a 18°

Maximum adjustability thanks to horizontal rotation at 350° with stop and double vertical rotation, pull out 45° and pull in 18°

CRI > 90 - SDCM < 3

Elevata qualità cromatica della luce grazie a led "prime brand"
Ottima resa del colore con CRI > 90
Minimo scostamento cromatico con
MacAdam SDCM < 3

High lighting performance thanks to "prime brand" led
High color rendition CRI > 90
Deviation colour matching MacAdam SDCM < 3



Emergency Kit

Operation time	Switching time	Recharging time	Minimum Recessing hole (*)	IP	Weight	Code
1 hour	0,5 sec.	24 h.	75 mm	IP20	0,43 kg	DRV9092
3 hours	0,5 sec.	24 h.	100 mm	IP20	0,88 kg	DRV9091

(*) per l'installazione in controsoffitto verificare la compatibilità con il foro di incasso; vedi dettagli a pagina 522
 (*) for installation in false ceiling check the compatibility with the recessing hole; see details to page 522

MOBY

Optical Info p. 533

Version	Power	Hole size	Optic	Code	Light temperature	CRI	SDCM	Weight	Light output	Colour
On / Off	12 W	ø 90 mm	15°	RTL30101	3000 K	> 90	< 3	0,32 Kg	1211 lm	white
				RTL30102	4000 K	> 90	< 3	0,32 Kg	1224 lm	white
			24°	RTL30103	3000 K	> 90	< 3	0,32 Kg	1213 lm	white
				RTL30104	4000 K	> 90	< 3	0,32 Kg	1227 lm	white
			36°	RTL30105	3000 K	> 90	< 3	0,32 Kg	1216 lm	white
				RTL30106	4000 K	> 90	< 3	0,32 Kg	1231 lm	white
	24 W	ø 125 mm	15°	RTL30201	3000 K	> 90	< 3	0,74 Kg	2445 lm	white
				RTL30202	4000 K	> 90	< 3	0,74 Kg	2459 lm	white
			24°	RTL30203	3000 K	> 90	< 3	0,74 Kg	2448 lm	white
				RTL30204	4000 K	> 90	< 3	0,74 Kg	2463 lm	white
			36°	RTL30205	3000 K	> 90	< 3	0,74 Kg	2452 lm	white
				RTL30206	4000 K	> 90	< 3	0,74 Kg	2468 lm	white
	33 W	ø 145 mm	15°	RTL30301	3000 K	> 90	< 3	0,86 Kg	3390 lm	white
				RTL30302	4000 K	> 90	< 3	0,86 Kg	3403 lm	white
			24°	RTL30303	3000 K	> 90	< 3	0,86 Kg	3394 lm	white
				RTL30304	4000 K	> 90	< 3	0,86 Kg	3408 lm	white
			36°	RTL30305	3000 K	> 90	< 3	0,86 Kg	3399 lm	white
				RTL30306	4000 K	> 90	< 3	0,86 Kg	3413 lm	white
			60°	RTL30307	3000 K	> 90	< 3	0,86 Kg	3403 lm	white
				RTL30308	4000 K	> 90	< 3	0,86 Kg	3418 lm	white
	42 W	ø 170 mm	15°	RTL30401	3000 K	> 90	< 3	1,28 Kg	4269 lm	white
				RTL30402	4000 K	> 90	< 3	1,28 Kg	4285 lm	white
			24°	RTL30403	3000 K	> 90	< 3	1,28 Kg	4274 lm	white
				RTL30404	4000 K	> 90	< 3	1,28 Kg	4290 lm	white
			36°	RTL30405	3000 K	> 90	< 3	1,28 Kg	4280 lm	white
				RTL30406	4000 K	> 90	< 3	1,28 Kg	4296 lm	white
			60°	RTL30407	3000 K	> 90	< 3	1,28 Kg	4284 lm	white
				RTL30408	4000 K	> 90	< 3	1,28 Kg	4302 lm	white

□ 220÷240Vac | IP40

UP to 103 lm/W | UP to UGR<19 | L80/B20 50.000 h. | CRI>90 | RG1 | SDCM<3

Installabili in controsoffitti di spessore compreso fra 5 mm. e 25 mm.
Models are suitable for false ceiling from 5 mm. up to 25 mm. thick.

Versioni dimmerabili / Dimmable versions

con regolazione via cavo / wired dimmable

version	code suffix	note	example
Push	DM	per ordinare la versione PUSH aggiungere DM alla fine del codice to order the PUSH version add DM to the end of the code	RTL-----DM
DALI	DA	per ordinare la versione DALI aggiungere DA alla fine del codice to order the DALI version add DA to the end of the code	RTL-----DA

1...10 V - Disponibile su richiesta / Dimming on demande

BOBBY

Bobby il downlight ideale per l'illuminazione puntuale di tutti gli ambienti. Realizzato in un unico pezzo, il corpo in pressofusione di alluminio con dissipatore integrato garantisce la massima dissipazione del calore. Con una gamma completa da 6W a 22W e un valore di UGR < 19, Bobby è in grado di produrre una luce brillante, ricca di cromie e durevole nel tempo grazie ai CoB Led "Prime Label" con resa cromatica CRI > 90 e indice di MacAdam < 3. Il driver "flicker free" incluso completa l'apparecchio rendendo l'installazione estremamente semplice e veloce.

Bobby is the ideal downlight for the punctual illumination of all environments with a UGR value of <19. Made in one piece, the die-cast aluminum body with integrated heat sink ensures maximum heat dissipation. With a complete range from 6W to 22W, Bobby is able to produce a bright and long-lasting light thanks to the "Prime Label" CoB LEDs (CRI > 90 and MacAdam index <3). The included "flicker free" driver completes the appliance making installation extremely simple and fast.



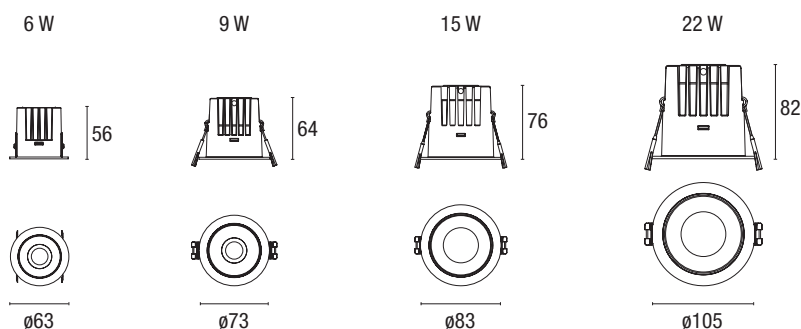

Versioni 6 W e 9 W installabili in controsoffitti di spessore compreso fra 5 mm. e 25 mm.
The 6 W e 9 W models are suitable for false ceiling from 5 mm. up to 25 mm. thick.

Versioni 15 W e 22 W installabili in controsoffitti di spessore compreso fra 5 mm. e 35 mm.
The 15 W e 22 W models are suitable for false ceiling from 5 mm. up to 35 mm. thick.

Optical Info p. 531

Version	Power	Code	Optic	Hole size	Light temperature	CRI	SDCM	Weight	Light output	Colour
On / Off	6 W	RTL12121	38°	ø 55 mm	3000 K	> 90	< 3	0,18 Kg	455 lm	matt white
		RTL12122	38°		4000 K	> 90	< 3	0,18 Kg	502 lm	matt white
	9 W	RTL12221	38°	ø 65 mm	3000 K	> 90	< 3	0,20 Kg	722 lm	matt white
		RTL12222	38°		4000 K	> 90	< 3	0,20 Kg	797 lm	matt white
	15 W	RTL12321	38°	ø 75 mm	3000 K	> 90	< 3	0,30 Kg	1439 lm	matt white
		RTL12322	38°		4000 K	> 90	< 3	0,30 Kg	1508 lm	matt white
22 W	RTL12421	38°	ø 90 mm	3000 K	> 90	< 3	0,54 Kg	2220 lm	matt white	
	RTL12422	38°		4000 K	> 90	< 3	0,54 Kg	2332 lm	matt white	
PUSH	6 W	RTL12121DM	38°	ø 55 mm	3000 K	> 90	< 3	0,18 Kg	455 lm	matt white
		RTL12122DM	38°		4000 K	> 90	< 3	0,18 Kg	502 lm	matt white
	9 W	RTL12221DM	38°	ø 65 mm	3000 K	> 90	< 3	0,20 Kg	722 lm	matt white
		RTL12222DM	38°		4000 K	> 90	< 3	0,20 Kg	797 lm	matt white
	15 W	RTL12321DM	38°	ø 75 mm	3000 K	> 90	< 3	0,30 Kg	1439 lm	matt white
		RTL12322DM	38°		4000 K	> 90	< 3	0,30 Kg	1508 lm	matt white
22 W	RTL12421DM	38°	ø 90 mm	3000 K	> 90	< 3	0,54 Kg	2220 lm	matt white	
	RTL12422DM	38°		4000 K	> 90	< 3	0,54 Kg	2332 lm	matt white	

□ 220÷240Vac | IP40

UP to 102 lm/W | UP to UGR<19 | L80/B20 50.000 h. | CRI>90 | RG1 | SDCM<3

1...10 V - Disponibile su richiesta / Dimming on demande

Emergency Kit

Operation time	Switching time	Recharging time	Minimum Recessing hole (*)	IP	Weight	Code
1 hour	0,5 sec.	24 h.	75 mm	IP20	0,43 kg	DRV9092
3 hours	0,5 sec.	24 h.	100 mm	IP20	0,88 kg	DRV9091

(*) per l'installazione in controsoffitto verificare la compatibilità con il foro di incasso; vedi dettagli a pagina 522

(*) for installation in false ceiling check the compatibility with the recessing hole; see details to page 522

JANGO

La serie Jango è composta da piccoli proiettori di tipo fisso e orientabile, di forma rotonda o quadrata, con diverse profondità di incasso ed equipaggiati con driver sia on / off sia dimmerabile a taglio di fase. Una gamma completa per realizzare accenti luminosi con luce di qualità: i led CoB ad alta resa cromatica CRI > 90 e SDCM < 3 esaltano i colori degli oggetti illuminati con una luce intensa e brillante e i riflettori sono di tipo speculare a faccette curve progressive per una migliore diffusione della luce all'interno del fascio di emissione.

The Jango series is composed by small fix and adjustable projectors, of round or square shape, with different recess depths and equipped with both on / off and phase cut dimmable driver. A complete range for the realization of lighting accents with a quality light: the high color rendering CoB LEDs CR I > 90 and SDCM < 3 enhance colors of the illuminated objects with an intense and bright light; reflectors are specular with progressive curved faces for a better diffusion of light within the emission beam angle.



Fix



Adj

Fix
UGR < 19Adj
UGR < 19Fix
UGR < 19Adj
UGR < 19

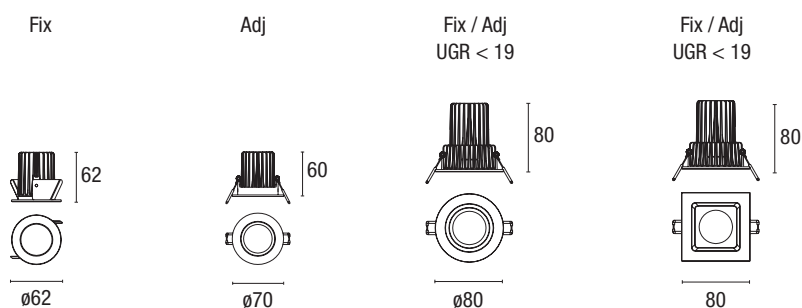

Installabili in controsoffitti di spessore compreso fra 5 mm. e 25 mm.
Models are suitable for false ceiling from 5 mm. up to 25 mm. thick.

Optical Info p. 531

Version	Power	Optic	Model	Code	Light temperature	CRI	SDCM	Weight	Light output	Hole size	Colour	
On / Off	9 W	40°	round	fix	INC1180	3000 K	> 90	< 3	0,26 Kg	875 lm	ø 53 mm	white
				adjustable	INC1182	3000 K	> 90	< 3	0,26 Kg	875 lm	ø 60 mm	white
		40° UGR<19	round	fix	INC1184	3000 K	> 90	< 3	0,26 Kg	875 lm	ø 70 mm	white
				adjustable	INC1186	3000 K	> 90	< 3	0,26 Kg	875 lm	ø 70 mm	white
			square	fix	INC1190	3000 K	> 90	< 3	0,26 Kg	875 lm	75x75 mm	white
				adjustable	INC1192	3000 K	> 90	< 3	0,26 Kg	875 lm	75x75 mm	white
Dimmerabile phase cut IGBT - TRIAC	9 W	40°	round	fix	INC1180D	3000 K	> 90	< 3	0,26 Kg	875 lm	ø 53 mm	white
				adjustable	INC1182D	3000 K	> 90	< 3	0,26 Kg	875 lm	ø 60 mm	white
		40° UGR<19	round	fix	INC1184D	3000 K	> 90	< 3	0,26 Kg	875 lm	ø 70 mm	white
				adjustable	INC1186D	3000 K	> 90	< 3	0,26 Kg	875 lm	ø 70 mm	white
			square	fix	INC1190D	3000 K	> 90	< 3	0,26 Kg	875 lm	75x75 mm	white
				adjustable	INC1192D	3000 K	> 90	< 3	0,26 Kg	875 lm	75x75 mm	white

SHOW_IP65

Show è un incassato professionale di dimensioni ridotte equipaggiato con led CoB ad alta qualità cromatica, con valori di CRI > 90 e SDCM < 3. Impermeabile all'acqua e alla polvere, Show si distingue per il suo grado IP65, che lo rende adatto ad essere installato anche in ambienti dove è richiesta una particolare attenzione alla protezione degli apparecchi e alla loro pulizia. Grazie a questa caratteristica Show mantiene più facilmente nel tempo le performance luminose date dal led e dall'ottica speculare che lo equipaggia.

Professional recessed product of small size equipped with high quality chromatic CoB LEDs, with CRI > 90 and SDCM < 3 values. Water and dustproof, Show stands out for its IP65 rating, which makes it suitable for installation even in areas where special attention as for protection and cleaning of lighting fixtures is required.



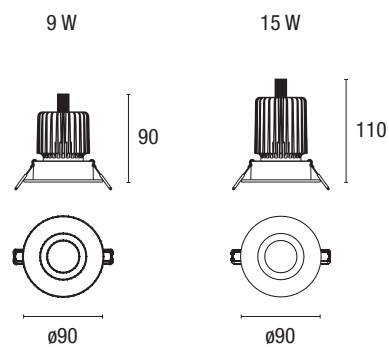

Installabili in controsoffitti di spessore compreso fra 5 mm. e 25 mm.
Models are suitable for false ceiling from 5 mm. up to 25 mm. thick.

Optical Info p. 531

Version	Power	Optic	Code	Light temperature	CRI	SDCM	Weight	Light output	Hole size	Colour
On / Off	9 W	40°	INC1043	3000 K	> 90	< 3	0,23 Kg	875 lm	Ø 75 mm	white
	15 W	40°	INC1044	3000 K	> 90	< 3	0,29 Kg	1525 lm	Ø 75 mm	white

□ 220÷240Vac | IP65

UP to 97 lm/W | UP to UGR<19 | L80/B20 50.000 h. | CRI>90 | RG1 | SDCM<3

FOCUS

Gli incassi della gamma Focus sono progettati per l'illuminazione d'accento in spazi piccoli e medi. Molto contenuti nelle dimensioni ma decisamente performanti vengono proposti in diverse misure e potenze. La scelta tra MICRO, MINI, MEDIUM e BIG consente l'utilizzo dell'apparecchio più adatto alle necessità. Sono disponibili versioni fisse ed orientabili. Tutti i modelli si configurano per scelta cromatica, colore del prodotto e gestione (On/Off, DALI, Push, Taglio di fase). Diversi i fasci di emissione garantiti da ottiche di grande efficienza. Il LED è collocato in posizione arretrata e caratterizza l'apparecchio per cut off elevati, garantendo effetti luce dal notevole impatto estetico. Il corpo è realizzato in tornitura di alluminio e presenta sistemi d'installazione e fissaggio semplificati. Diversi i colori disponibili nella gamma Focus: oltre al bianco e nero si può scegliere il tabacco, sabbia e silver. Il driver è separato dal prodotto, la nostra proposta consente la scelta dell'alimentazione in ragione dell'impianto da realizzare.

The recessed downlight Focus range are designed to be used for accent lighting in small and medium spaces. Small in size but great performance, they are proposed in different sizes and powers. The choice between MICRO, MINI, MEDIUM and BIG allows the use of the appliance that best suits your needs. Our range include fix and adjustable versions. All models can be configured by color choice, product color and management (On/Off, DALI, Push, Phase Cut). Optics with different beam angle can be selected. LED is placed in the back position and characterizes the product for remarkable cut off. The product is made of aluminium turning and presente simplified installation. Different colors available in the Focus range: in addition to black and white you can choose tobacco, sand and silver. The driver is separate from the product, our proposal include several power supply in reason of the installation.





FOCUS

MICRO



MINI



MEDIUM



.....
BIG



.....
ADJ ROUND



.....
ADJ SQUARE

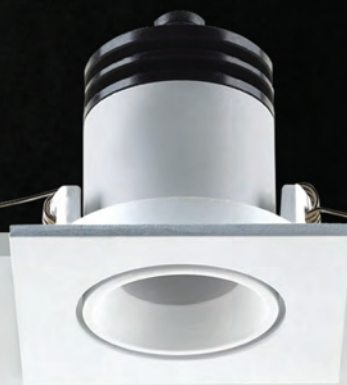



FOCUS_MICRO

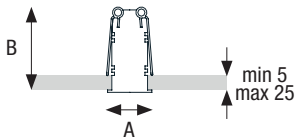

Power	Lumen output	Hole size	Product dimension		Weight	*code to complete
			A	B		
1 W	110 lm	∅ 19 mm	∅ 24 mm	42 mm	0,036 Kg	FO-OAA ● ◻ ▼

◆ 350mA | 2,80 V | IP20

CRI>90 | SDCM<3

L80/B20 50.000 h.

Driver non incluso; circuito in serie (max 5 apparecchi)

Driver not included; serial circuit (max 5 fixtures)

Optical Info p. 531

* Select your option

CCT	●	Optic	◻	Colour	▼
2700 K	1	15°	1	White	W
3000 K	2	24°	2	Black	B
4000 K	3	38°	3	Sand	V
				Silver	G
				Tobacco	O

Alimentazioni / Feeding



L'alimentatore non passa attraverso foro di incasso dell'apparecchio. Prevedere il suo posizionamento in altro luogo

The driver does not pass through the hole of installation in the false ceiling. Consider its placement elsewhere

on-off

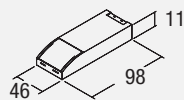

n° 1...5 pz / pcs

code	DRV1008
power	6 W
output voltage	2 ÷ 18V DC
voltage range	220Vac
insulation class / IP	class II / IP20

Phase cut IGBT / TRIAC

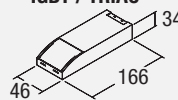

n° 1...5 pz / pcs

code	DRV1012
power	17 W
output voltage	2 ÷ 47V DC
voltage range	220Vac
insulation class / IP	class II / IP20

DALI / PUSH

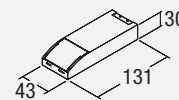

n° 2...5 pz / pcs

code	DRV1030
power	18 W
output voltage	9 ÷ 52V DC
voltage range	220Vac
insulation class / IP	class II / IP20

FOCUS_MINI

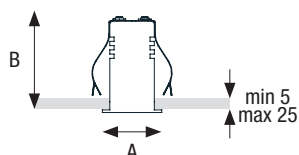

Power	Lumen output	Hole size	Product dimension		Weight	*code to complete
			A	B		
3 W	150 lm	∅ 25 mm	∅ 28 mm	45 mm	0,049 Kg	FO-MAA ● ◻ ▼

◇ 700mA | 2,90 V | IP20

CRI>90 | SDCM<3

L80/B20 50.000 h.

Driver non incluso; circuito in serie (max 5 apparecchi)
Driver not included; serial circuit (max 5 fixtures)



FOCUS_MEDIUM

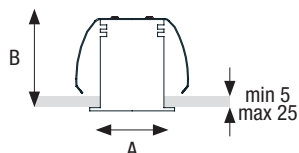

Power	Lumen output	Hole size	Product dimension		Weight	*code to complete
			A	B		
3 W	150 lm	∅ 32 mm	∅ 40 mm	48 mm	0,049 Kg	FO-NAA ● ◻ ▼

◇ 700mA | 2,90 V | IP20

CRI>90 | SDCM<3

L80/B20 50.000 h.

Driver non incluso; circuito in serie (max 5 apparecchi)
Driver not included; serial circuit (max 5 fixtures)

Optical Info p. 531

* Select your option

CCT	Optic	Colour
2700 K	24°	White
3000 K	38°	Black
4000 K		Sand
		Silver
		Tobacco

Alimentazioni / Feeding



L'alimentatore non passa attraverso foro di incasso dell'apparecchio. Prevedere il suo posizionamento in altro luogo

The driver does not pass through the hole of installation in the false ceiling. Consider its placement elsewhere

on-off

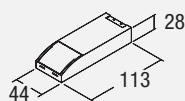

n° 1...5 pz / pcs

code	DRV1005
power	20 W
output voltage	2 ÷ 29V DC
voltage range	220Vac
insulation class / IP	class II / IP20

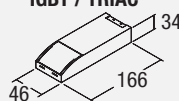
Phase cut
IGBT / TRIAC

n° 1...5 pz / pcs

code	DRV1012
power	32 W
output voltage	2 ÷ 47V DC
voltage range	220Vac
insulation class / IP	class II / IP20

DALI / PUSH

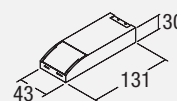

n° 2...5 pz / pcs

code	DRV1030
power	25 W
output voltage	9 ÷ 38V DC
voltage range	220Vac
insulation class / IP	class II / IP20



FOCUS_BIG

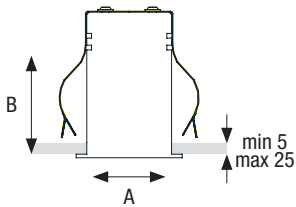

Power	Lumen output	Hole size	Product dimension		Weight	*code to complete
			A	B		
6 W	400 lm	ø 42 mm	ø 45 mm	63 mm	0,14 Kg	F0-AAA ● ◻ ▼
◊ 150mA 36 V IP20 CRI>90 SDCM<3 L80/B20 50.000 h. Driver non incluso Driver not included						

Optical Info p. 531

* Select your option

CCT	●	Optic	◻	Colour	▼
2700 K	1	15°	1	White	W
3000 K	2	24°	2	Black	B
4000 K	3	38°	3	Sand	V
		55°	4	Silver	G
				Tobacco	0

Alimentazioni / Feeding



L'alimentatore passa attraverso il foro di incasso dell'apparecchio.

The driver pass through the hole of installation in the false ceiling.

on / off

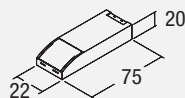

n° 1 pz / pc

code	DRV1071
power	6 W
output voltage	8 ÷ 40V DC
voltage range	220Vac
insulation class / IP	class II / IP20



L'alimentatore non passa attraverso foro di incasso dell'apparecchio. Prevedere il suo posizionamento in altro luogo

The driver does not pass through the hole of installation in the false ceiling. Consider its placement elsewhere

DALI / PUSH

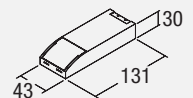

n° 1 pz / pcs

code	DRV1030
power	8 W
output voltage	9 ÷ 52V DC
voltage range	220Vac
insulation class / IP	class II / IP20



FOCUS_ADJ ROUND

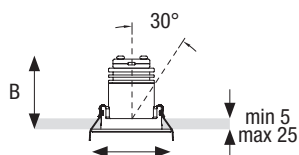

A

Power	Lumen output	Hole size	Product dimension		Weight	*code to complete
			A	B		
3 W	150 lm	∅ 45 mm	∅ 52 mm	50 mm	0,10 Kg	FO-NAB ● ◻ ▼

◆ 700mA | 2,90 V | IP20

CRI>90 | SDCM<3

L80/B20 50.000 h.

Driver non incluso; circuito in serie (max 5 apparecchi)
Driver not included; serial circuit (max 5 fixtures)



FOCUS_ADJ SQUARE

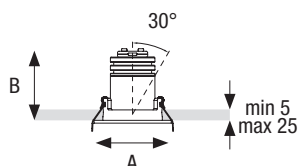

A

Power	Lumen output	Hole size	Product dimension		Weight	*code to complete
			A	B		
3 W	150 lm	∅ 45 mm	50x50 mm	50 mm	0,10 Kg	FO-NBB ● ◻ ▼

◆ 700mA | 2,90 V | IP20

CRI>90 | SDCM<3

L80/B20 50.000 h.

Driver non incluso; circuito in serie (max 5 apparecchi)
Driver not included; serial circuit (max 5 fixtures)

Optical Info p. 531

* Select your option

CCT	●	Optic	◻	Colour	▼
2700 K	1	15°	1	White	W
3000 K	2	38°	3	Black	B
4000 K	3	55°	4	Sand	V
				Silver	G
				Tobacco	O

Alimentazioni / Feeding



L'alimentatore non passa attraverso foro di incasso dell'apparecchio. Prevedere il suo posizionamento in altro luogo

The driver does not pass through the hole of installation in the false ceiling. Consider its placement elsewhere

on-off

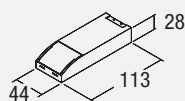

n° 1...5 pz / pcs

code	DRV1005
power	20 W
output voltage	2 ÷ 29V DC
voltage range	220Vac
insulation class / IP	class II / IP20

Phase cut IGBT / TRIAC



n° 1...5 pz / pcs

code	DRV1012
power	32 W
output voltage	2 ÷ 47V DC
voltage range	220Vac
insulation class / IP	class II / IP20

DALI / PUSH

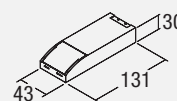

n° 2...5 pz / pcs

code	DRV1030
power	25 W
output voltage	9 ÷ 38V DC
voltage range	220Vac
insulation class / IP	class II / IP20

PILL

Apparecchio orientabile da incasso per interni realizzato in alluminio anodizzato nero con sistema di fissaggio tramite molle in acciaio. Tre ottiche secondarie (lenti) e due temperature colore disponibili. Data l'altezza ridottissima e le dimensioni contenute è ideale, oltre che per illuminazione di teche e nicchie, per l'installazione in mensole ed ovunque siano richiesti spessori ridotti.

Adjustable recessed luminaire for indoor installation. Black anodized aluminum body and steel springs fixing system. Three secondary optics (lenses) and two colour temperature available. Thanks to small height and the small dimensions it is ideal for lighting of display cases and niches, as well as for installation in shelves and everywhere it's required reduced thickness.



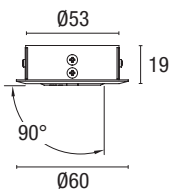

Optical Info p. 531

Power	Size	Code	Light temperature	CRI	Source	Optic	Weight	Light output	Hole size	Colour
3 W	Round Ø 60 mm. x h. 19 mm.	RTL48101	3000 K	> 80	POWER LED	10°	0,09 Kg	270 lm	Ø 56 mm	white
		RTL48102	3000 K	> 80	POWER LED	25°	0,09 Kg	270 lm	Ø 56 mm	white
		RTL48103	3000 K	> 80	POWER LED	40°	0,09 Kg	270 lm	Ø 56 mm	white
		RTL48107	3000 K	> 80	POWER LED	10°	0,09 Kg	270 lm	Ø 56 mm	black
		RTL48108	3000 K	> 80	POWER LED	25°	0,09 Kg	270 lm	Ø 56 mm	black
		RTL48109	3000 K	> 80	POWER LED	40°	0,09 Kg	270 lm	Ø 56 mm	black
		RTL48104	4000 K	> 80	POWER LED	10°	0,09 Kg	290 lm	Ø 56 mm	white
		RTL48105	4000 K	> 80	POWER LED	25°	0,09 Kg	290 lm	Ø 56 mm	white
		RTL48106	4000 K	> 80	POWER LED	40°	0,09 Kg	290 lm	Ø 56 mm	white
		RTL48110	4000 K	> 80	POWER LED	10°	0,09 Kg	290 lm	Ø 56 mm	black
		RTL48111	4000 K	> 80	POWER LED	25°	0,09 Kg	290 lm	Ø 56 mm	black
		RTL48112	4000 K	> 80	POWER LED	40°	0,09 Kg	290 lm	Ø 56 mm	black

700mA | 2,90 V | IP40

 Driver non incluso; circuito in serie (max 5 apparecchi)
 Driver not included; serial circuit (max 5 fixtures)

Alimentazioni / Feeding



L'alimentatore non passa attraverso foro di incasso dell'apparecchio. Prevedere il suo posizionamento in altro luogo

The driver does not pass through the hole of installation in the false ceiling. Consider its placement elsewhere

on-off

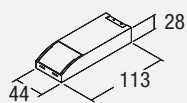

n° 1...5 pz / pcs

code	DRV1005
power	20 W
output voltage	2 ÷ 29V DC
voltage range	220Vac
insulation class / IP	class II / IP20

Phase cut IGBT / TRIAC

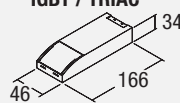

n° 1...5 pz / pcs

code	DRV1012
power	32 W
output voltage	2 ÷ 47V DC
voltage range	220Vac
insulation class / IP	class II / IP20

DALI / PUSH

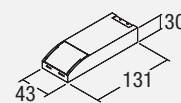

n° 2...5 pz / pcs

code	DRV1030
power	25 W
output voltage	9 ÷ 38V DC
voltage range	220Vac
insulation class / IP	class II / IP20

MICROLED

Incassato calpestabile di dimensioni ridotte adatto ad installazioni in interni ed esterni. Il prodotto è realizzato in tornitura di alluminio con ghiera frontale in acciaio AISI 316. Vetro di protezione frontale leggermente satinato ottimizza l'emissione. L'apparecchio viene fornito completo di kit d'installazione per fissaggio con molla in acciaio su pannelli e cassaforma PBT per muratura. Cavo di alimentazione cm 30.

A compact recessed walkover luminaire suitable for both indoor and outdoor installations. The product is made with turned aluminum and features a front ring in AISI 316 stainless steel. The slightly frosted front protective glass optimizes light emission. The luminaire comes complete with an installation kit for steel spring mounting on panels and PBT casing for masonry. It includes a 30 cm power cable.



Bianco
White



Acciaio
Stainless steel

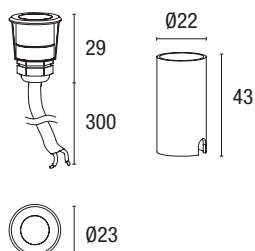

Optical Info p. 532

Power	Size	Code	Light temperature	CRI	Source	Optic	Weight	Light output	Hole size	Colour
1 W	Round Ø 23 mm. x h. 29 mm.	EST58121	3000 K	> 80	POWER LED	120°	0,02 Kg	95 lm	Ø 19 mm	stainless steel
		EST58120	4000 K		POWER LED	120°		105 lm		stainless steel
		EST58123	3000 K		POWER LED	120°	95 lm	white		
		EST58122	4000 K		POWER LED	120°	105 lm	black		

350mA | 2,90 V | IP67

 Driver non incluso; circuito in serie (max 5 apparecchi)
 Driver not included; serial circuit (max 5 fixtures)

Alimentazioni / Feeding



L'alimentatore non passa attraverso foro di incasso dell'apparecchio. Prevedere il suo posizionamento in altro luogo

The driver does not pass through the hole of installation in the false ceiling. Consider its placement elsewhere

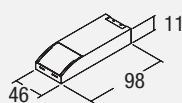
on-off

n° 1...5 pz / pcs

code	DRV1008
power	6 W
output voltage	2 ÷ 18V DC
voltage range	220Vac
insulation class / IP	class II / IP20

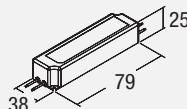
on-off IP67

n° 1...5 pz / pcs

code	DRV1069
power	max 14 W
output voltage	3 ÷ 40V DC
voltage range	220Vac
insulation class / IP	class II / IP67

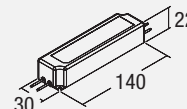
on-off IP67

n° 2...5 pz / pcs

code	DRV1050
power	max 16,8 W
output voltage	6 ÷ 48V DC
voltage range	220Vac
insulation class / IP	class II / IP67

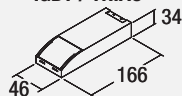
Phase cut IGBT / TRIAC

n° 1...5 pz / pcs

code	DRV1012
power	17 W
output voltage	2 ÷ 47V DC
voltage range	220Vac
insulation class / IP	class II / IP20

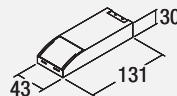
DALI / PUSH

n° 2...5 pz / pcs

code	DRV1030
power	18 W
output voltage	9 ÷ 52V DC
voltage range	220Vac
insulation class / IP	class II / IP20

MINILED

Incassato calpestabile adatto ad installazioni in interni ed esterni. Il prodotto è realizzato in tornitura di alluminio con ghiera frontale in acciaio AISI 316. disponibili ottiche con emissione 10/20/30°. Completa l'apparecchio un vetro di protezione frontale. L'apparecchio viene fornito completo di kit d'installazione per fissaggio con molla in acciaio su pannelli e cassaforma PBT per muratura. Cavo di alimentazione cm 30.

A walkover luminaire suitable for both indoor and outdoor installations. The product is made with turned aluminum and features a front ring in AISI 316 stainless steel. Optics with 10/20/30° beam angles are available. The luminaire is equipped with a front protective glass. It comes complete with an installation kit for steel spring mounting on panels and PBT casing for masonry. A 30 cm power cable is included.



Bianco
White



Acciaio
Stainless steel



Acciaio
Stainless steel

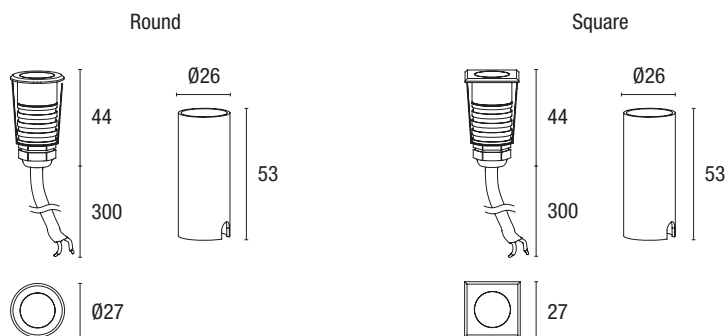

Optical Info p. 532

Power	Size	Code	Light temperature	CRI	Source	Optic	Weight	Light output	Hole size	Colour
1 W	Round Ø 27 mm. x h. 44 mm.	EST58100	4000 K	> 80	POWER LED	10°	0,06 Kg	120 lm	Ø 23 mm	stainless steel
		EST58101	4000 K	> 80	POWER LED	20°	0,06 Kg	120 lm	Ø 23 mm	stainless steel
		EST58102	4000 K	> 80	POWER LED	30°	0,06 Kg	120 lm	Ø 23 mm	stainless steel
		EST58103	3000 K	> 80	POWER LED	10°	0,06 Kg	110 lm	Ø 23 mm	stainless steel
		EST58104	3000 K	> 80	POWER LED	20°	0,06 Kg	110 lm	Ø 23 mm	stainless steel
		EST58105	3000 K	> 80	POWER LED	30°	0,06 Kg	110 lm	Ø 23 mm	stainless steel
		EST58133	3000 K	> 80	POWER LED	10°	0,06 Kg	110 lm	Ø 23 mm	white
		EST58134	3000 K	> 80	POWER LED	20°	0,06 Kg	110 lm	Ø 23 mm	white
		EST58135	3000 K	> 80	POWER LED	30°	0,06 Kg	110 lm	Ø 23 mm	white
		EST58130	4000 K	> 80	POWER LED	10°	0,06 Kg	120 lm	Ø 23 mm	white
		EST58131	4000 K	> 80	POWER LED	20°	0,06 Kg	120 lm	Ø 23 mm	white
EST58132	4000 K	> 80	POWER LED	30°	0,06 Kg	120 lm	Ø 23 mm	white		
1 W	Quadrato / Square 27 x 27 x 44 mm.	EST58113	3000 K	> 80	POWER LED	10°	0,06 Kg	110 lm	Ø 23 mm	stainless steel
		EST58114	3000 K	> 80	POWER LED	20°	0,06 Kg	110 lm	Ø 23 mm	stainless steel
		EST58115	3000 K	> 80	POWER LED	30°	0,06 Kg	110 lm	Ø 23 mm	stainless steel

350mA | 2,90 V | IP67

 Driver non incluso; circuito in serie (max 5 apparecchi)
 Driver not included; serial circuit (max 5 fixtures)

Alimentazioni / Feeding



L'alimentatore non passa attraverso foro di incasso dell'apparecchio. Prevedere il suo posizionamento in altro luogo

The driver does not pass through the hole of installation in the false ceiling. Consider its placement elsewhere

on-off

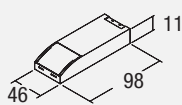

n° 1...5 pz / pcs

code	DRV1008
power	6 W
output voltage	2 ÷ 18V DC
voltage range	220Vac
insulation class / IP	class II / IP20

on-off IP67

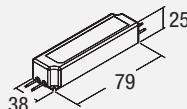

n° 1...5 pz / pcs

code	DRV1069
power	max 14 W
output voltage	3 ÷ 40V DC
voltage range	220Vac
insulation class / IP	class II / IP67

on-off IP67

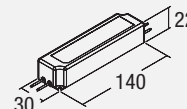

n° 2...5 pz / pcs

code	DRV1050
power	max 16,8 W
output voltage	6 ÷ 48V DC
voltage range	220Vac
insulation class / IP	class II / IP67

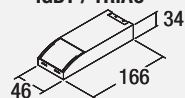
Phase cut
IGBT / TRIAC

n° 1...5 pz / pcs

code	DRV1012
power	17 W
output voltage	2 ÷ 47V DC
voltage range	220Vac
insulation class / IP	class II / IP20

DALI / PUSH

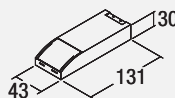

n° 2...5 pz / pcs

code	DRV1030
power	18 W
output voltage	9 ÷ 52V DC
voltage range	220Vac
insulation class / IP	class II / IP20

PLASTER RECESSED

Quanto proposto dalla nostra selezione “gessi” consente di illuminare al meglio lo spazio integrando la sorgente luminosa nel soffitto o nella parete in cartongesso. Questa soluzione, a scomparsa totale, unita all’impiego di lampadine GU10, garantisce un’installazione d’impatto estetico minimale e dal buon rendimento luminoso. Ogni apparecchio ha caratteristiche e peculiarità distintive e viene fornito completo di portalampade. Il prodotto consente l’accesso ed il montaggio della lampadina dalla parte frontale, semplificando al massimo sostituzioni e manutenzioni.

Our “gypsum” downlight range allow the best performance in the interior lighting. All the products could integrate the light source into ceiling or plasterboard. This product is designed as “ghost” solution. Combined with GU10 bulbs guarantee low impact installations and good light output. Each luminaires has distinctive features and peculiarities. All products include GU10 socket . Front access for easy bulb installation/ replacing. They minimize the cost for assistance and maintenance.





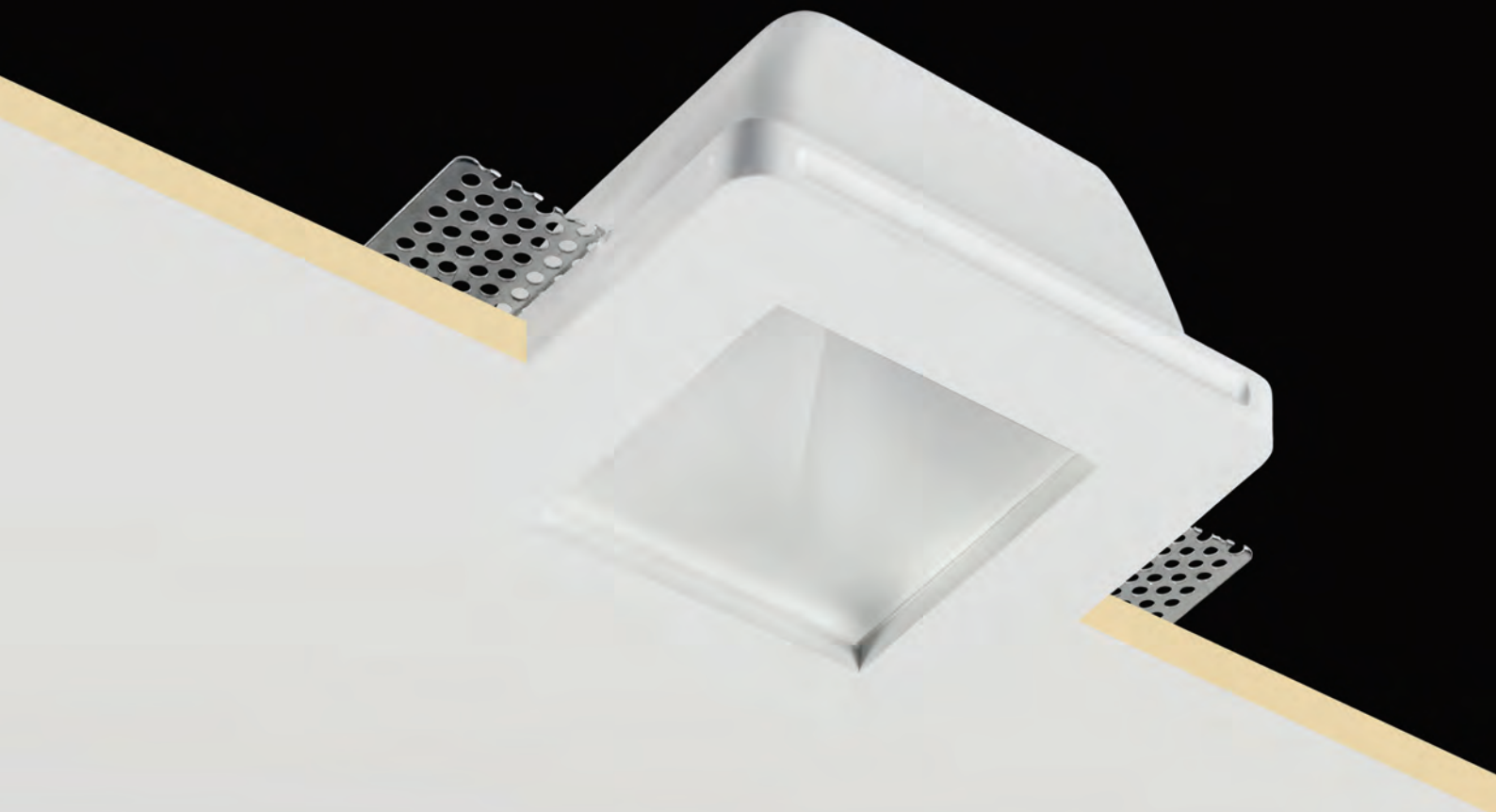

INC10010

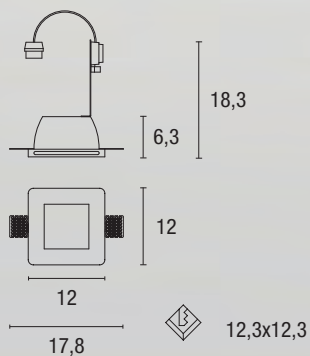

INC1500

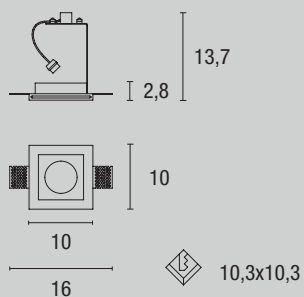

Model	Downlight	Downlight
Code	INC10010	INC1500
Finishing	White	White
Power / lumen output	1x max 35W (not included)	1x max 35W (not included)
Beam angle	\	\
CCT	\	\
Source	GU10	GU10
IP	IP20	IP20
Panel thick min-max	12 mm	12 mm
Weight	0,8 Kg	0,4 Kg

□ 220÷240Vac | IP20

Lamp not included



Led module 220V
Accessories not included

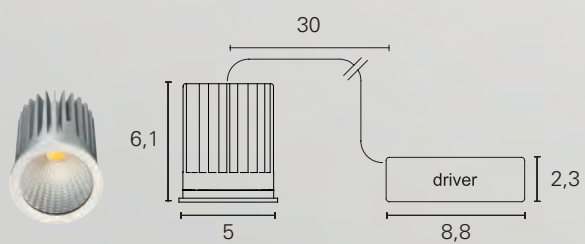

Model	Code	Power feeding	Power / Lumen Output	CCT	Beam angle	Dimmable	Lifetime
Kit LED + Driver	LED8012	220÷240 V	9 W - 815 lm	3000 K	40°	no	L80 / B20 – 50.000 h

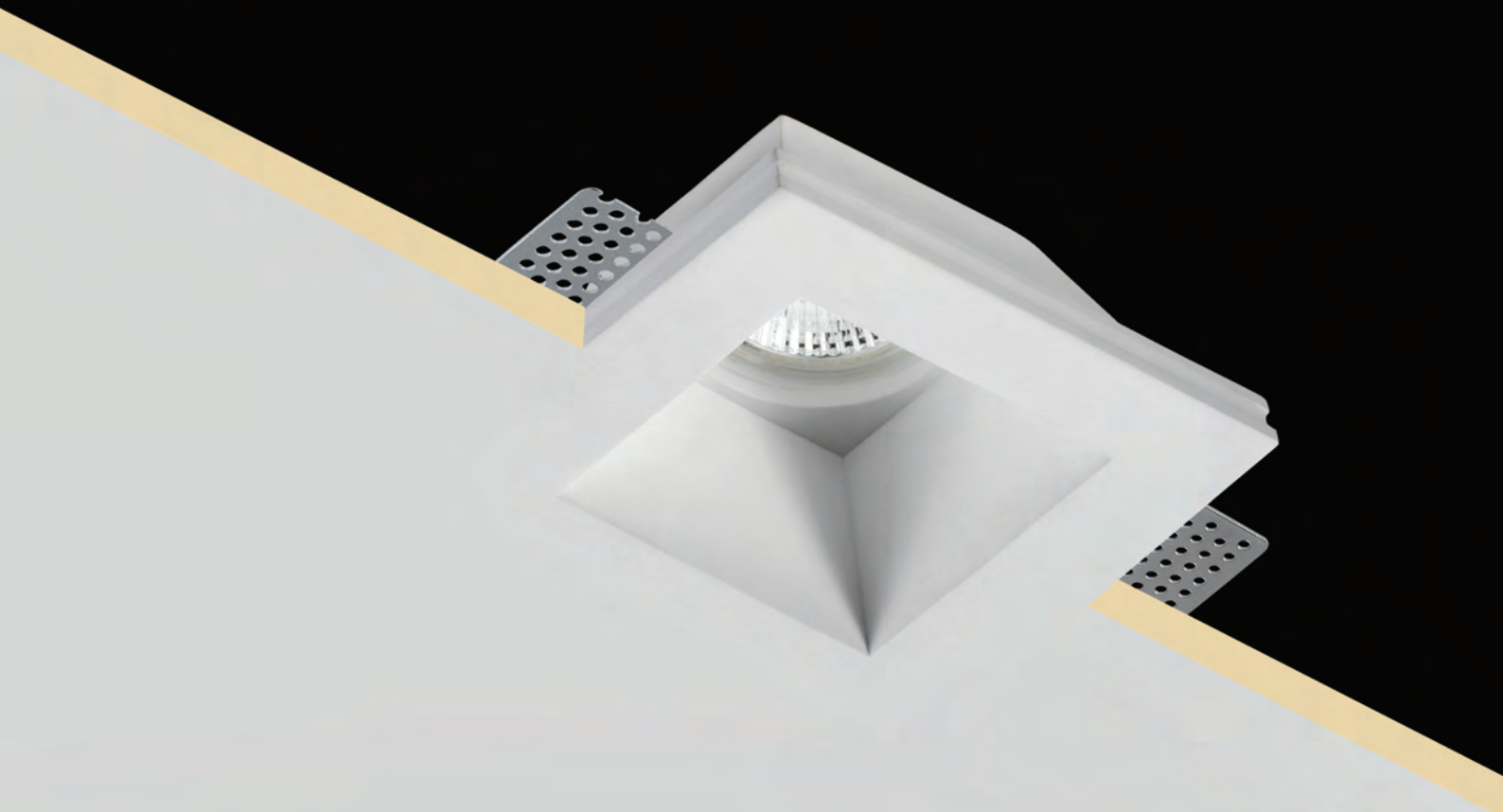

INC1503

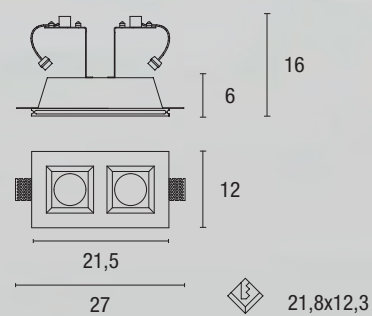

INC1501

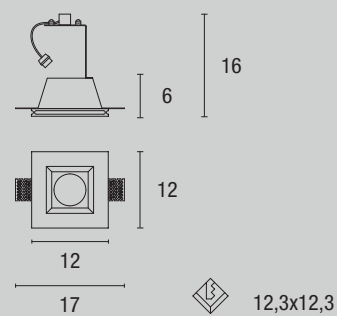

Model	Downlight - 2x Spots	Downlight - 1x Spot
Code	INC1503	INC1501
Finishing	White	White
Power / lumen output	2x max 35W (not included)	1x max 35W (not included)
Beam angle	\	\
CCT	\	\
Source	GU10	GU10
IP	IP20	IP20
Panel thick min-max	12 mm	12 mm
Weight	1,1 Kg	0,7 Kg

□ 220÷240Vac | IP20

Lamp not included / Lamp holder bracket included



Led module 220V
Accessories not included

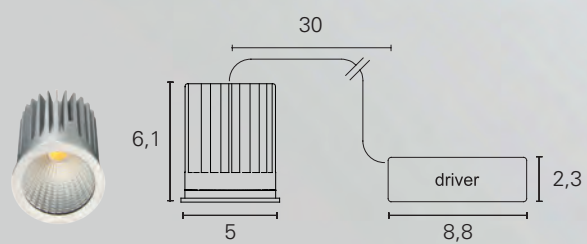

Model	Code	Power feeding	Power / Lumen Output	CCT	Beam angle	Dimmable	Lifetime
Kit LED + Driver	LED8012	220÷240 V	9 W - 815 lm	3000 K	40°	no	L80 / B20 - 50.000 h



INC10518

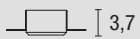

INC10531

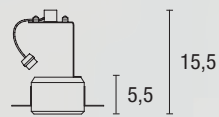

INC10517

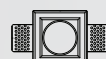
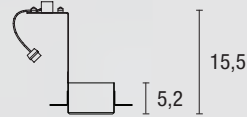

Model	Downlight - Led	Downlight - GU10	Downlight - GU10
Code	INC10518	INC10531	INC10517
Finishing	White	White	White
Power / lumen output	3W / 170 lm	1x max 35W (not included)	1x max 35W (not included)
Beam angle	80°	\	\
CCT	3000 K	\	\
Source	Power LED	GU10	GU10
IP	IP20	IP20	IP20
Panel thick min-max	15 mm	15 mm	9-15 mm
Weight	0,3 Kg	0,5 Kg	0,4 Kg

□ 220÷240Vac | IP20

Lamp not included / Lamp holder bracket included

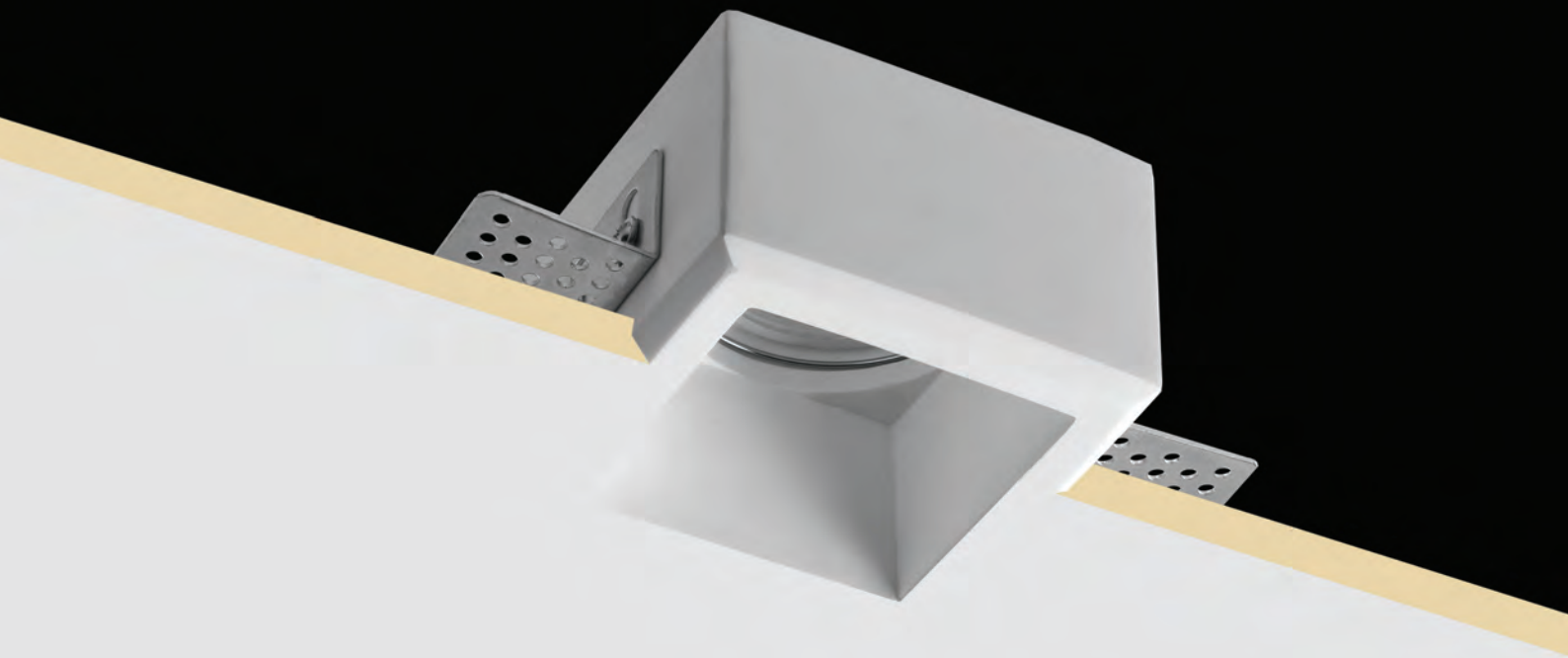

Led module 220V
Accessories not included

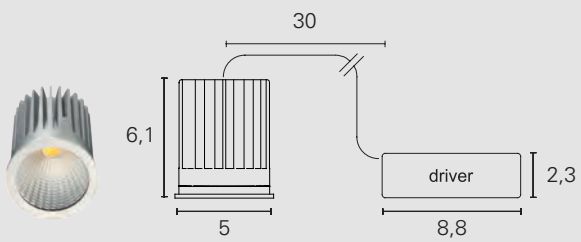

Model	Code	Power feeding	Power / Lumen Output	CCT	Beam angle	Dimmable	Lifetime
Kit LED + Driver	LED8012	220÷240 V	9 W - 815 lm	3000 K	40°	no	L80 / B20 – 50.000 h



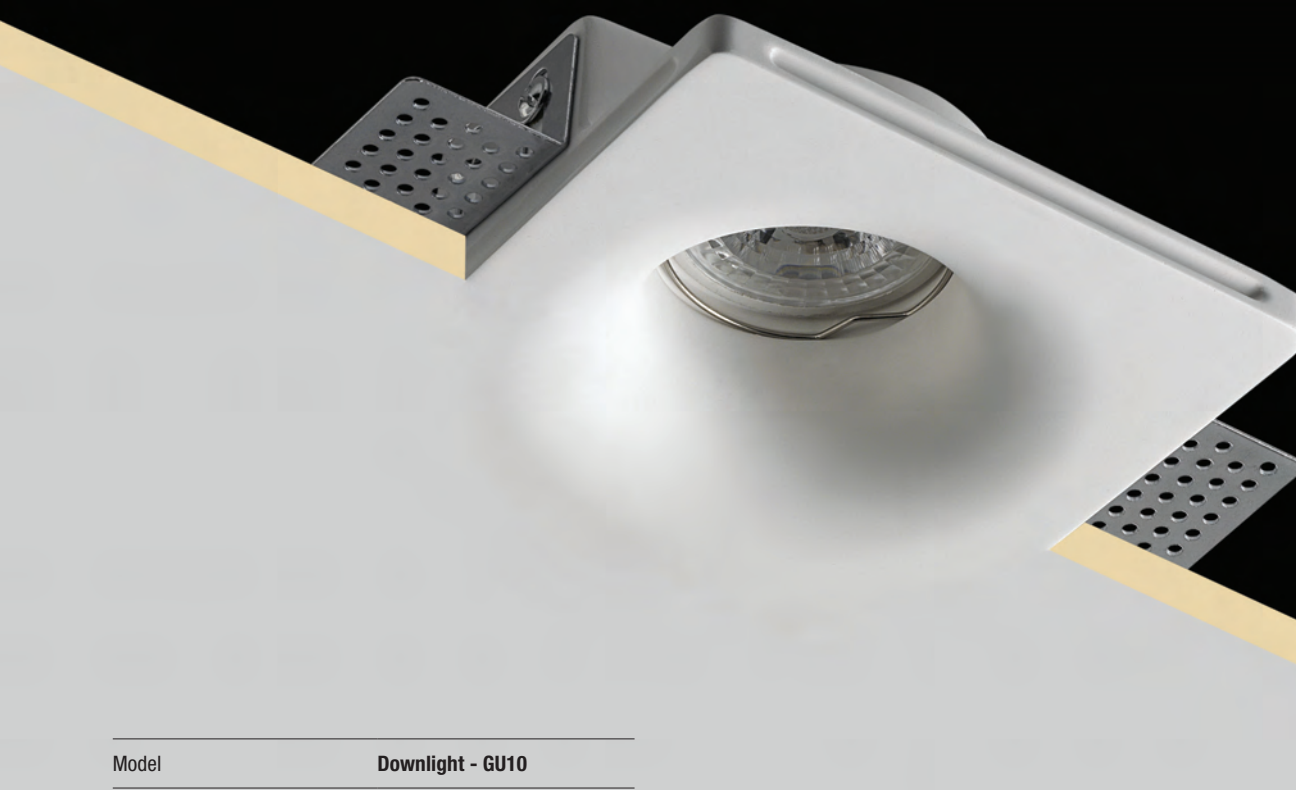

Model	Downlight - GU10
Code	INC10535
Finishing	White
Power / lumen output	1x max 35W (not included)
Beam angle	\
CCT	\
Source	GU10
IP	IP20
Panel thick min-max	15 mm
Weight	0,6 Kg

220÷240Vac | IP20
 Lamp not included
Lamp holder bracket included

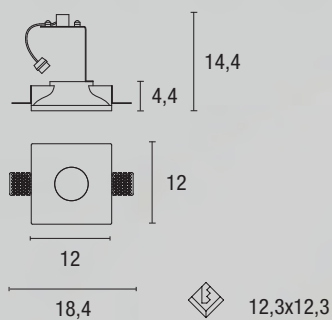
INC10535

Led module 220V Accessories not included

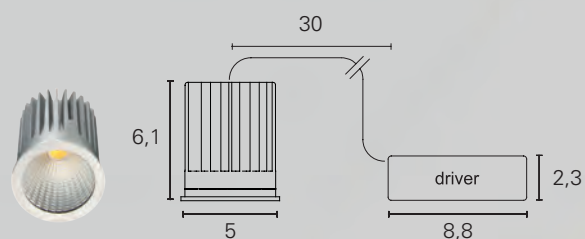

Model	Code	Power feeding	Power / Lumen Output	CCT	Beam angle	Dimmable	Lifetime
Kit LED + Driver	LED8012	220÷240 V	9 W - 815 lm	3000 K	40°	no	L80 / B20 - 50.000 h



INC10020

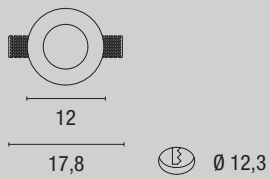
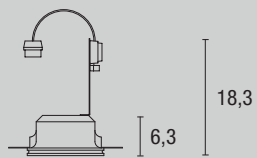

INC1508

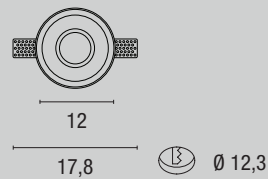
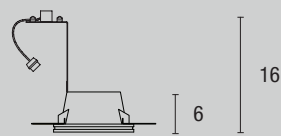

INC1518

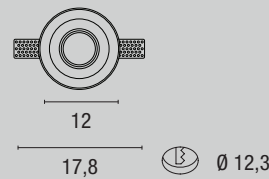
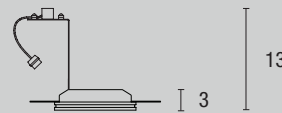

Model	Downlight - GU10	Downlight - GU10	Downlight - GU10
Code	INC10020	INC1508	INC1518
Finishing	White	White	White
Power / lumen output	1x max 35W (not included)	1x max 35W (not included)	1x max 35W (not included)
Beam angle	\	\	\
CCT	\	\	\
Source	GU10	GU10	GU10
IP	IP20	IP20	IP20
Panel thick min-max	12 mm	12 mm	12 mm
Weight	0,6 Kg	0,4 Kg	0,4 Kg

□ 220÷240Vac | IP20

Lamp not included / Lamp holder bracket included

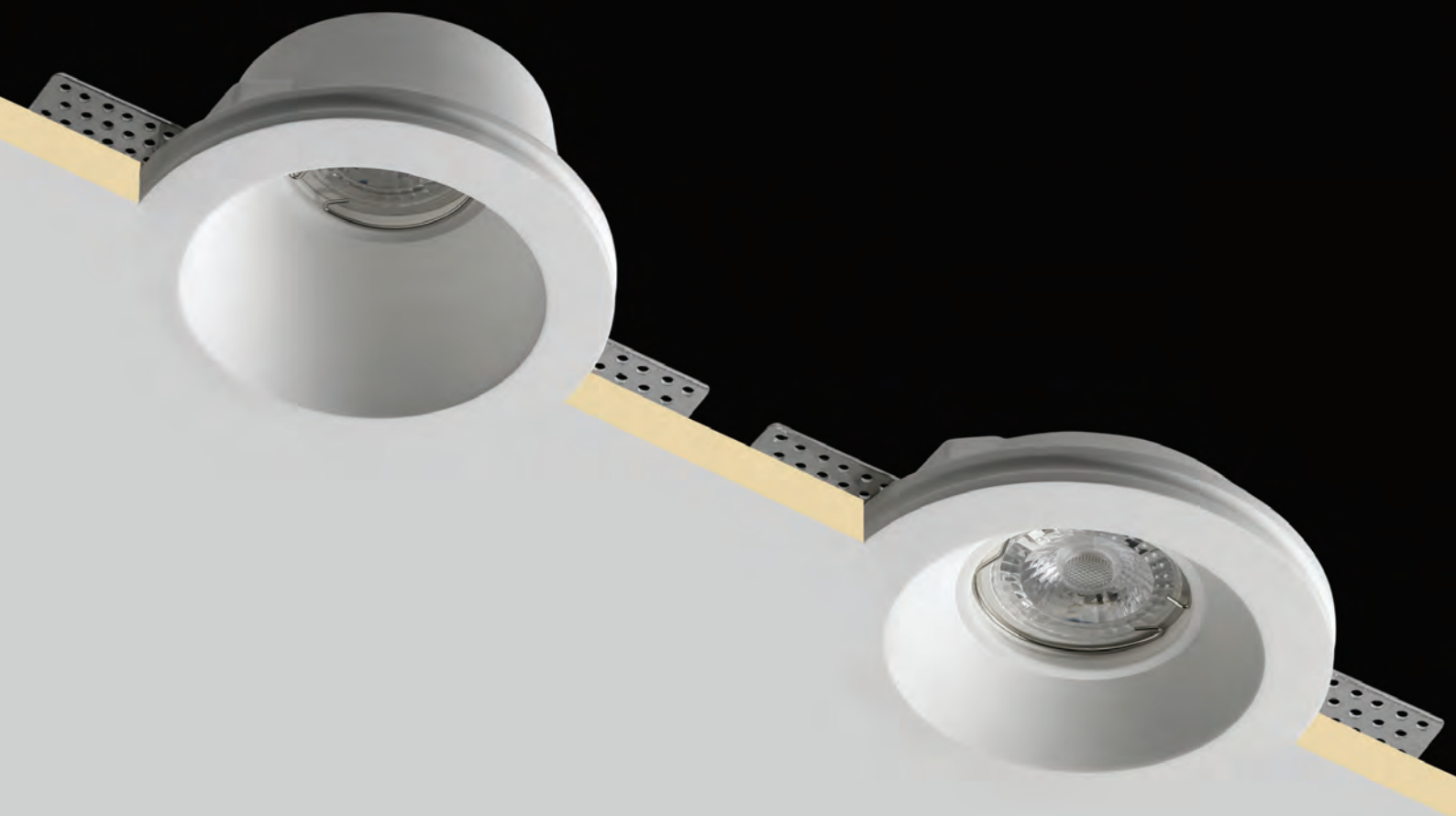

Led module 220V
Accessories not included

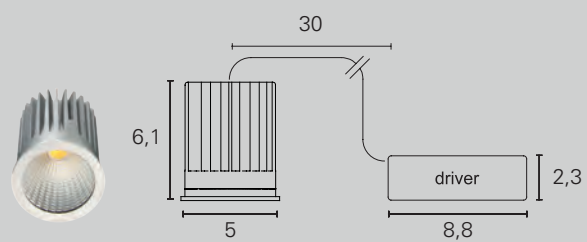

Model	Code	Power feeding	Power / Lumen Output	CCT	Beam angle	Dimmable	Lifetime
Kit LED + Driver	LED8012	220÷240 V	9 W - 815 lm	3000 K	40 °	no	L80 / B20 – 50.000 h



INC1502

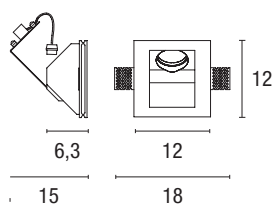

12,3x12,3

INC1515

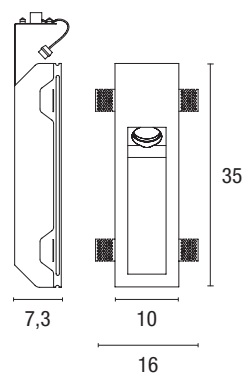

10,3x35,3



Model	Wall Mounting Recessed Square	Wall Mounting Recessed Rectangular
Code	INC1502	INC1515
Finishing	White	White
Power / lumen output	1x max 35W (not included)	1x max 35W (not included)
Beam angle	\	\
CCT	\	\
Source	GU10	GU10
IP	IP20	IP20
Panel thick min-max	12 mm	12 mm
Weight	0,6 Kg	1,3 Kg

□ 220÷240Vac | IP20

Lamp not included
Lamp holder bracket included

Led module 220V Accessories not included

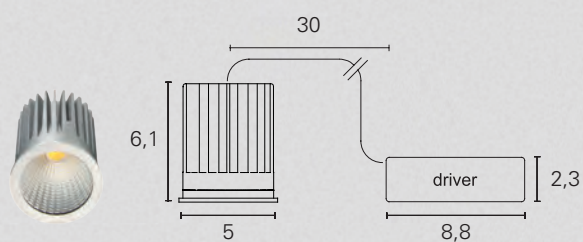

Model	Code	Power feeding	Power / Lumen Output	CCT	Beam angle	Dimmable	Lifetime
Kit LED + Driver	LED8012	220÷240 V	9 W - 815 lm	3000 K	40°	no	L80 / B20 – 50.000 h

GU10 RECESSED

Una serie di faretti da incasso in metallo utilizzabili nelle più disparate applicazioni. Rapidità e flessibilità d'installazione caratterizzano il successo di questa gamma. Disponibili con flusso luminoso fisso oppure orientabile, con cornice a vista oppure trimless. Corpo lampada realizzato in metallo verniciato con polveri epossidiche oppure in tornitura di alluminio. Predisposti per il montaggio di una lampadina attacco GU10 vengono forniti completi di portalampane.

Our range of recessed metal spotlights can be used in several applications. Easy and flexible installation characterize the success of these products. Available with fixed or adjustable luminous flux, visible edge or trimless. Epoxy powder painted metal body, additional versions are realized in massive aluminium. All models are designed for GU10 bulb, lamp holders included.







Model	Downlight - GU10
Code	INC00085
Finishing	White
Power / lumen output	1x max 50W (not included)
Beam angle	\
CCT	\
Source	GU10
IP	IP20
Panel thick min-max	\
Weight	0,3 Kg

☐ 220÷240Vac | IP20

Lamp not included
Lamp holder bracket included

INC00085

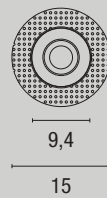
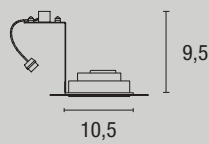

Ø 10,5



Model	Downlight - GU10
Code	INC00086
Finishing	White
Power / lumen output	1x max 50W (not included)
Beam angle	\
CCT	\
Source	GU10
IP	IP20
Panel thick min-max	\
Weight	0,4 Kg

□ 220÷240Vac | IP20

Lamp not included
Lamp holder bracket included

INC00086

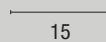
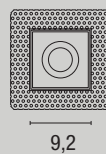
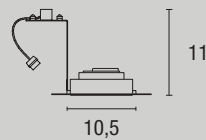

10,5x10,5

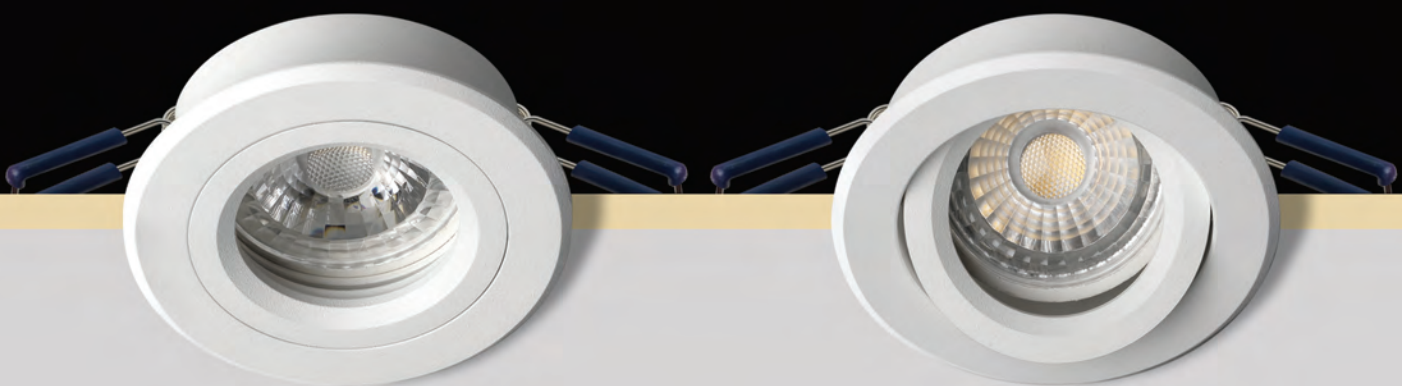

Model	Fixed Downlight Round	Adjustable Downlight Round	Adjustable Downlight Square
Code	INC00015	INC00025	INC00035
Finishing	White	White	White
Power / lumen output	1x max 50W (not included)	1x max 50W (not included)	1x max 50W (not included)
Beam angle	\	\	\
CCT	\	\	\
Source	GU10	GU10	GU10
IP	IP20	IP20	IP20
Panel thick min-max	20 mm	20 mm	20 mm
Weight	0,1 Kg	0,2 Kg	0,2 Kg

□ 220÷240Vac | IP20

Lamp not included / Lamp holder bracket included

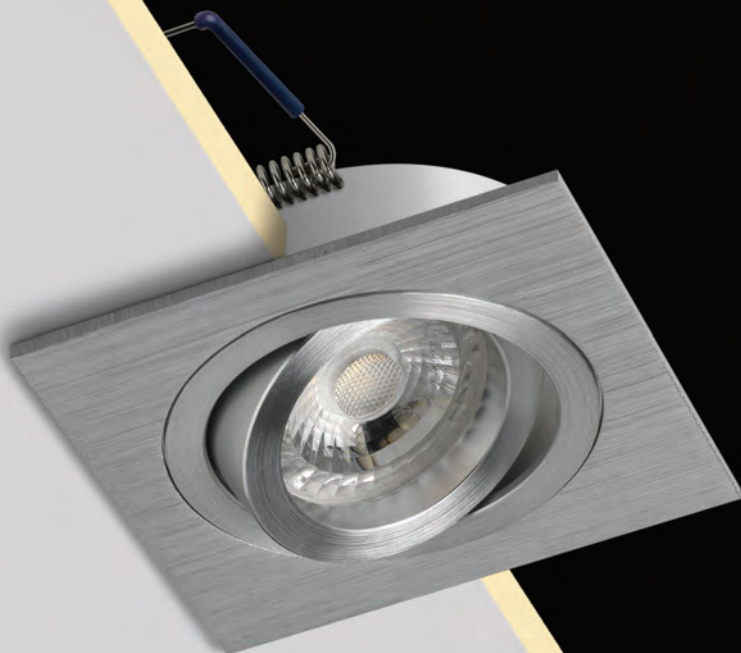

INC0015 / INC0002

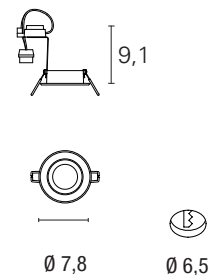

INC0025

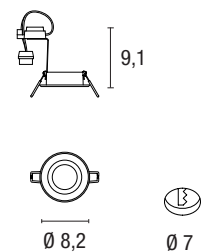

INC0035 / INC0007

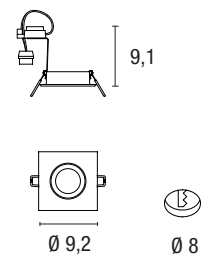

Fix Downlight Round	Adjustable Downlight Square
INC0002	INC0007
Aluminium	Aluminium
1x max 50W (not included)	1x max 50W (not included)
\	\
\	\
GU10	GU10
IP20	IP20
20 mm	20 mm
0,1 Kg	0,2 Kg

☐ 220÷240Vac | IP20 Lamp not included / Lamp holder bracket included

Colori / Colours

Aluminium



White





LIGHT PANELS

02

I N D E X



Backlit_p.166



Backlit UGR_p.168



**Led Panel
Smart_p.170**

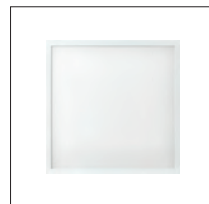

**Led Panel
Microprismatic_p.172**

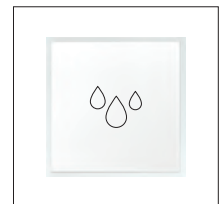

**Led Panel
IP65_p.174**

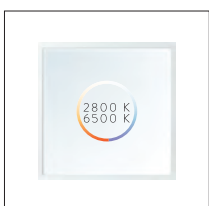

**Led Panel
Tunable_p.176**



Panel Box_p.180

BACKLIT

☐ 90 lm/W L80/B20 50.000h.

Backlit è un apparecchio a led di ultima generazione che si distingue per economicità, efficacia luminosa ed affidabilità nel tempo. Le sorgenti led posizionate sul retro dell'apparecchio emettono luce direttamente verso il basso ottenendo così le migliori prestazioni in condizioni termiche ottimali ed allungando la vita utile dei led il più possibile. Backlit si utilizza in appoggio all'interno di controsoffitti modulari oppure in abbinamento con le soluzioni Panel Box per l'installazione a plafone o a sospensione. Backlit è disponibile anche nelle versioni UGR<19.

Backlit is a latest generation LED fixture that stands out for its economy, luminous efficacy and reliability over time. The LED sources located on the back of the appliance emit light directly downwards to obtain the best performance in optimal operating conditions, making sources lifetime as longer as possible. Backlit can be installed as a recessed lighting panel for modular false ceilings or as pendant or ceiling mounted if matched with Panel Box's solutions.

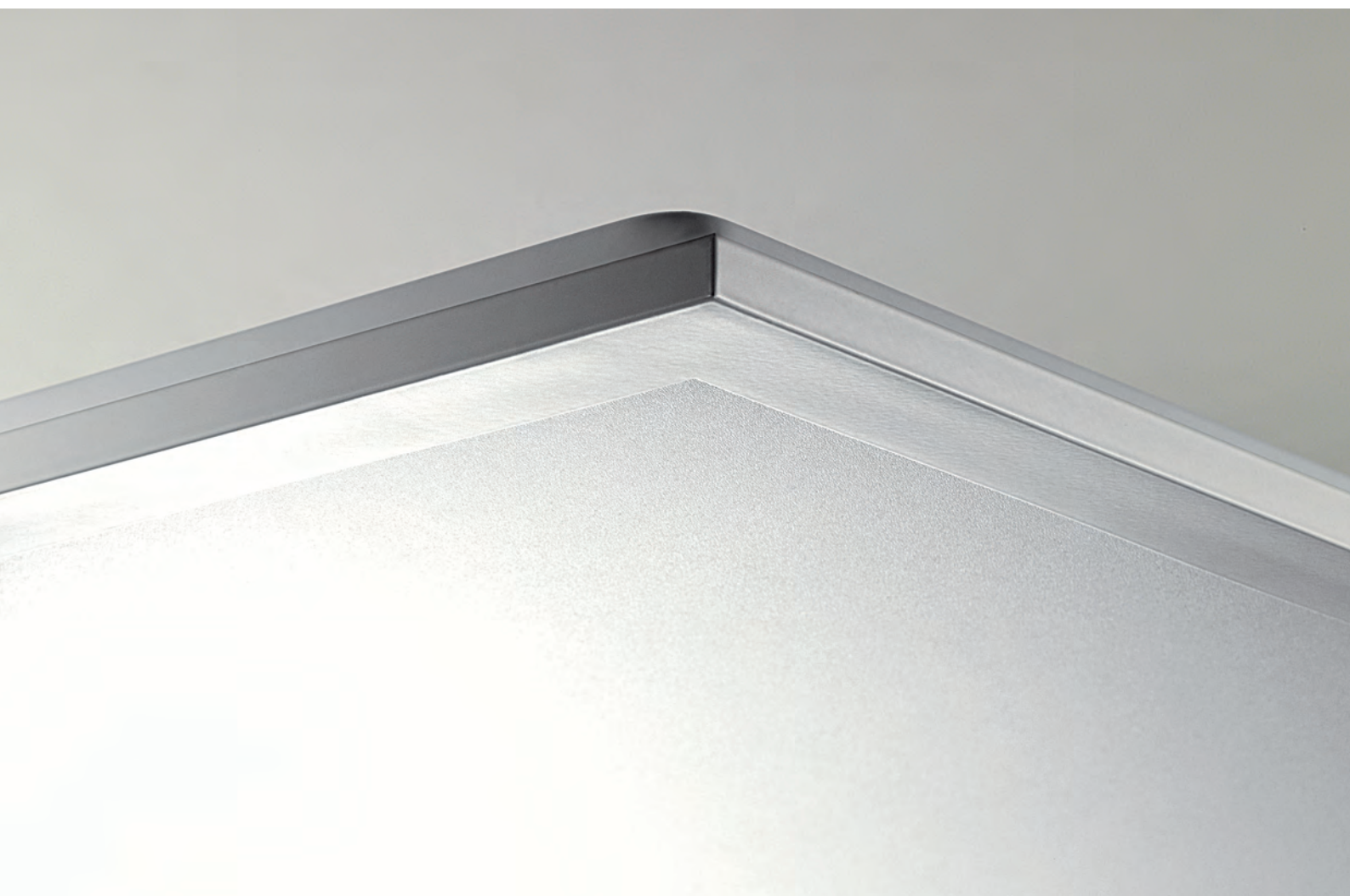

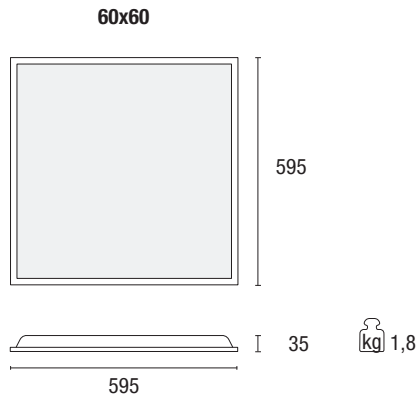

Optical Info p. 532

BACKLIT**CRI 80**

size	version	power	code	CCT	light output	UGR	optic	colour
60x60	On / Off	40 W	BAC56040	3000 K	3315 lm	≤ 22	120°	white
	220 ÷ 240 V		BAC56041	4000 K	3600 lm	≤ 22	120°	white

vedi accessori di installazione PANEL BOX a pg. 180.
see installing accessories PANEL BOX to pg 180.

**Dimensions**

vedi modalità di installazione a pg. 178.
see mounting operation to pg 178.

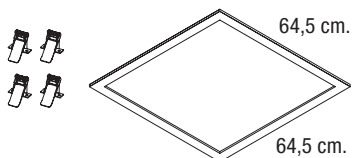
Kit Trimmed Recessed**INC1283**

Telaio bianco per installazione
ad incasso completo di clips.

White frame for recessed panel
installation with clips.

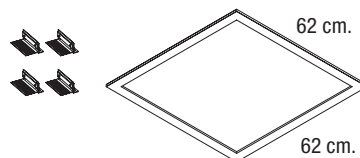
Kit Trimless Recessed**INC1290**

Telaio bianco per incasso a filo in
cartongesso con cornice a scomparsa
completo di staffe.

White frame for trimless mounting on
plasterboard with brackets and retractable
frames.

BACKLIT_UGR

□ 94lm/W UGR<19 L80/B20 50.000h.

Backlit UGR è il pannello ideale per gli impianti di illuminazione che devono garantire un attento controllo delle luminanze; grazie all'abbinamento fra le lenti "one to led" e lo schermo microprismatizzato, la sua emissione UGR<19 lo rende conforme alle normative EN per l'illuminazione degli ambienti di lavoro. Le sorgenti led, opportunamente posizionate all'interno del pannello, smaltiscono il calore nel miglior modo possibile ed emettono luce direttamente attraverso lo schermo prismatizzato, ottenendo elevate performances senza compromettere l'affidabilità nel tempo.

Backlit UGR is the ideal panel for lighting systems that guarantee careful luminance control; thanks to the combination of "one to led" lenses and the micro-prismatic screen, its UGR <19 emission makes it compliant with EN standards for lighting in the workplace. The LED sources, suitably positioned inside the panel, dissipate the heat in the best possible way and emit light directly through the microprismatic screen, obtaining high performances without compromising reliability over time.

60x60

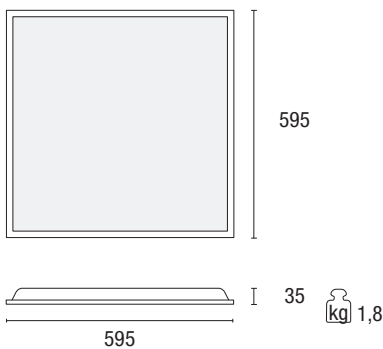

30x120

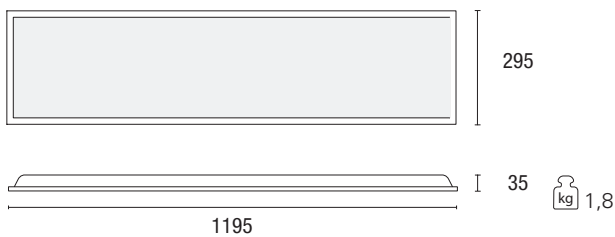

60x120



Backlit UGR<19

CRI 80

size	version	power	code	CCT	light output	UGR	optic	colour
60x60	On / Off	36 W	BAC56140	3000 K	3105 lm	< 19	90°	white
	220 ÷ 240 V		BAC56141	4000 K	3375 lm	< 19	90°	white
30x120	On / Off	36 W	BAC56142	3000 K	3075 lm	< 19	90°	white
	220 ÷ 240 V		BAC56143	4000 K	3340 lm	< 19	90°	white
60x120	On / Off	60 W	BAC56144	3000 K	5080 lm	< 19	90°	white
	220 ÷ 240 V		BAC56145	4000 K	5520 lm	< 19	90°	white

vedi accessori di installazione PANEL BOX a pg. 180.
see installing accessories PANEL BOX to pg 180.



Dimmable Driver Version

version	code	For Panel	IP	Class
DALI 220 ÷ 240 V	SLE0147	36 W	IP20	Class II
DALI 220 ÷ 240 V	SLE0149	60 W	IP20	Class I
PUSH 220 ÷ 240 V	SLE0148	36 W	IP20	Class II
PUSH 220 ÷ 240 V	SLE0150	60 W	IP20	Class I

1...10 V - Disponibile su richiesta / Dimming on demande

Emergency Kit

operation time	switching time	recharging time	minimum recessing hole (*)	IP	weight	code
1 hour	0,5 sec.	24 h.	Ø 75 mm.	IP20	0,43 kg	DRV9092
3 hours	0,5 sec.	24 h.	Ø 100mm.	IP20	0,88 kg	DRV9091

(*) per l'installazione in controsoffitto verificare la compatibilità con il foro di incasso; vedi dettagli a pagina 522
(* for installation in false ceiling check the compatibility with the recessing hole; see details to page 522)

Dimensions - solo per modello 60x60 - only for 60x60 model

vedi modalità di installazione a pg. 176.
see mounting operation to pg 176.

Kit Trimmed Recessed

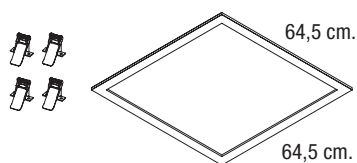
**INC1283**

Telaio bianco per installazione ad incasso completo di clips.
White frame for recessed panel installation with clips.

Kit Trimless Recessed

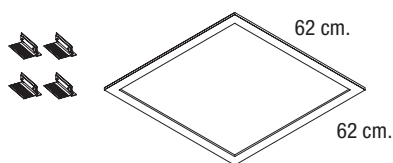
**INC1290**

Telaio bianco per incasso a filo in cartongesso con cornice a scomparsa completo di staffe.
White frame for trimless mounting on plasterboard with brackets and retractable frames.

LED PANEL_SMART

□ 110 lm/W UGR < 19 L80 / B20 50.000h.

La linea Led Panel Smart presenta un'ampia gamma di versioni per potenze, temperature di colore e alimentazioni. Tutte le versioni sono caratterizzate da un elevato controllo delle emissioni luminose per garantire il massimo comfort visivo con valori di UGR < 19 e dalla totale assenza di flickering.

The Led Panel Smart line is offered in a wide range of versions, in terms of output, colour temperatures and power supplies. All versions are characterized by enhanced luminous emission control to ensure maximum visual comfort, with a UGR < 19 and the complete absence of flicker.

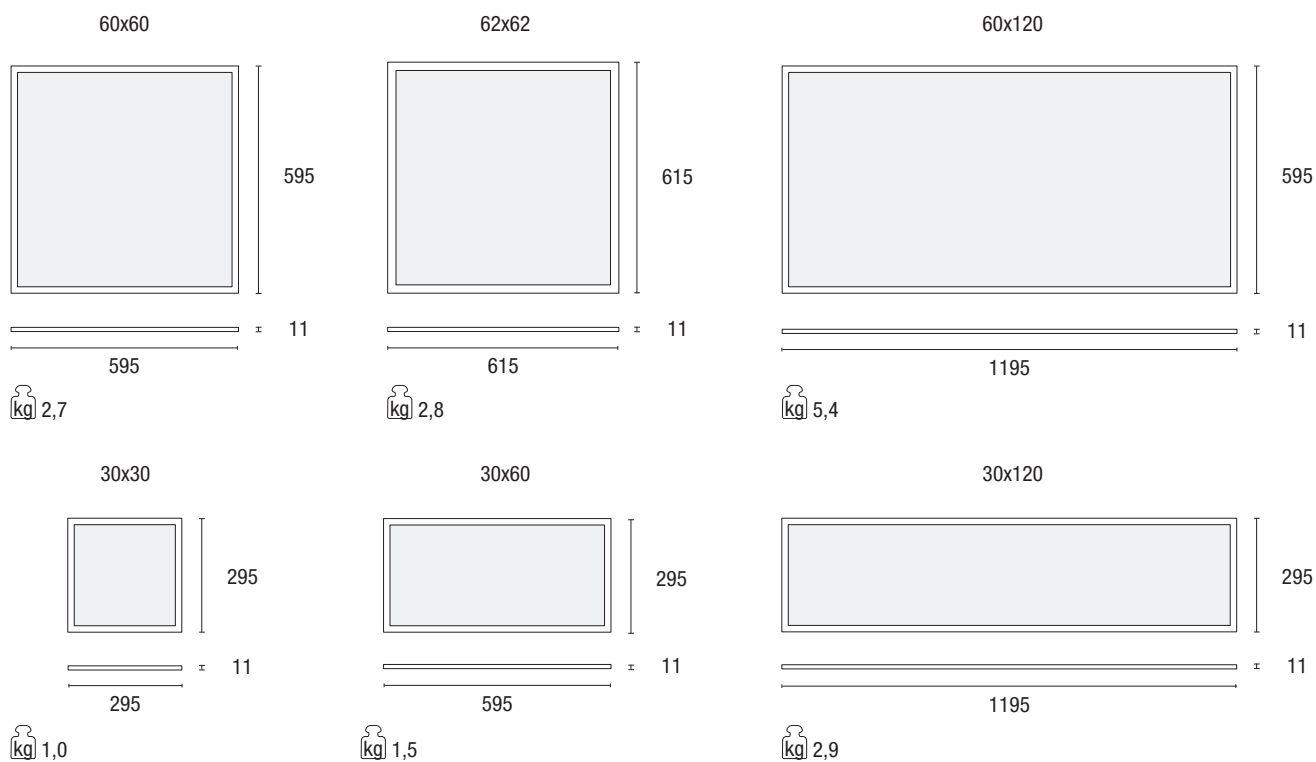

Led Panel Smart

CRI > 80

size	version	power	code	CCT	light output	UGR	optic	colour
60x60	On / Off 220 ÷ 240 V	36 W	INC1235	3000 K	3400 lm	≤ 19	120°	white
			INC1228	4000 K	3850 lm	≤ 19	120°	white
	50 W	INC1231	3000 K	4700 lm	≤ 19	120°	white	
		INC1225	4000 K	5100 lm	≤ 19	120°	white	
62x62	On / Off 220 ÷ 240 V	36 W	INC1278	3000 K	3400 lm	≤ 19	120°	white
			INC1276	4000 K	3850 lm	≤ 19	120°	white
	50 W	INC1279	3000 K	4700 lm	≤ 19	120°	white	
		INC1277	4000 K	5100 lm	≤ 19	120°	white	
60x120	On / Off 220 ÷ 240 V	60 W	INC1243	3000 K	6000 lm	≤ 19	120°	white
			INC1240	4000 K	6360 lm	≤ 19	120°	white
30x30	On / Off 220 ÷ 240 V	18 W	INC1273	3000 K	1420 lm	≤ 19	120°	white
			INC1270	4000 K	1550 lm	≤ 19	120°	white
30x60	On / Off 220 ÷ 240 V	36 W	INC1263	3000 K	3450 lm	≤ 19	120°	white
			INC1260	4000 K	3920 lm	≤ 19	120°	white
30x120	On / Off 220 ÷ 240 V	36 W	INC1253	3000 K	3850 lm	≤ 19	120°	white
			INC1250	4000 K	4130 lm	≤ 19	120°	white

vedi accessori di fissaggio a pg. 178 / see mounting accessories to pg 178.

Led Panel Smart

CRI > 90

size	version	power	code	CCT	light output	UGR	optic	colour
60x60	On / Off 220 ÷ 240 V	36 W	INC56503	3000 K	3260 lm	≤ 19	120°	white
			INC56500	4000 K	3720 lm	≤ 19	120°	white
30x120	On / Off 220 ÷ 240 V	36 W	INC56527	3000 K	3970 lm	≤ 19	120°	white
			INC56524	4000 K	3700 lm	≤ 19	120°	white
60x120	On / Off 220 ÷ 240 V	60 W	INC56533	3000 K	5700 lm	≤ 19	120°	white
			INC56530	4000 K	6040 lm	≤ 19	120°	white

vedi accessori di fissaggio a pg. 178 / see mounting accessories to pg 178.

Dimmable Driver Version

version	code	For Panel	IP	Class
DALI 220 ÷ 240 V	SLE0139	18 W	IP20	Class II
DALI 220 ÷ 240 V	SLE0141	36 W	IP20	Class II
DALI 220 ÷ 240 V	SLE0143	50 W	IP20	Class I
DALI 220 ÷ 240 V	SLE0145	60 W	IP20	Class I
PUSH 220 ÷ 240 V	SLE0140	18 W	IP20	Class II
PUSH 220 ÷ 240 V	SLE0142	36 W	IP20	Class II
PUSH 220 ÷ 240 V	SLE0144	50 W	IP20	Class I
PUSH 220 ÷ 240 V	SLE0146	60 W	IP20	Class I

1...10 V - Disponibile su richiesta / Dimming on demande

Emergency Kit

operation time	switching time	recharging time	minimum recessing hole (*)	IP	weight	code
1 hour	0,5 sec.	24 h.	Ø 75 mm.	IP20	0,43 kg	DRV9092
3 hours	0,5 sec.	24 h.	Ø 100mm.	IP20	0,88 kg	DRV9091

(*) per l'installazione in controsoffitto verificare la compatibilità con il foro di incasso; vedi dettagli a pagina 522

(*) for installation in false ceiling check the compatibility with the recessing hole; see details to page 522

LED PANEL_MICROPRISMATIC



 UPTO 110 lm/W UPTO UGR < 17 L80 / B20 50.000 h.

Panel Led Microprismatic è equipaggiato con il nuovo pannello “Glareless” costituito da uno speciale schermo microprismatico a 3 strati, il quale recupera il 20% in più del flusso emesso e riduce l’abbagliamento, garantendo un valore di UGR<17. Comfort visivo ottimale e assenza di flickering rendono Panel Led Microprismatic l’apparecchio idoneo per l’illuminazione degli ambienti dedicati alle attività lavorative dove si utilizzano monitor e computer portatili.

Micro prismatic Led Panel is fitted with the latest “Glareless” panel, which consists of a special prismatic 3 layer screens that harvests 20% more of the flux emitted and reduces glare, ensuring that a UGR value < 17. Optimal visual comfort and no flickering make Panel Led devices suitable for the lighting of environments dedicated to working activities where monitors and laptops are used.

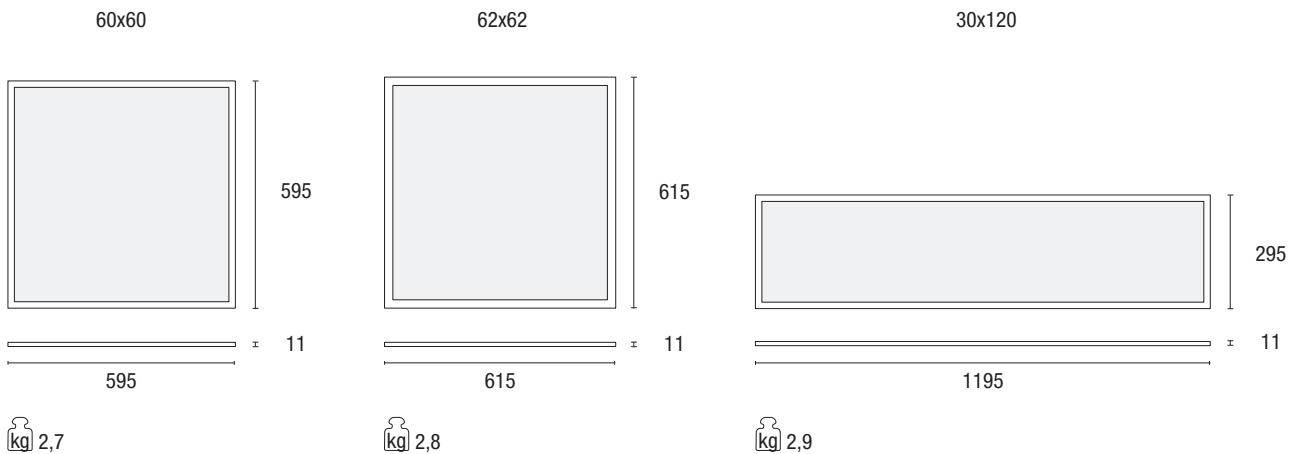

UGR < 17



No Glare

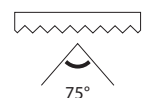

High visual comfort



Optical Info p. 533

Led Panel Microprismatic

CRI > 80

size	version	power	code	CCT	light output	UGR	optic	colour
60x60	On / Off	36 W	INC56244	3000 K	3500 lm	≤ 17	75°	white
	220 ÷ 240 V		INC56241	4000 K	3960 lm	≤ 17	75°	white
62x62	On / Off	36 W	INC56256	3000 K	3500 lm	≤ 17	75°	white
	220 ÷ 240 V		INC56253	4000 K	3960 lm	≤ 17	75°	white
30x120	On / Off	36 W	INC56250	3000 K	3500 lm	≤ 17	75°	white
	220 ÷ 240 V		INC56247	4000 K	3960 lm	≤ 17	75°	white

vedi accessori di fissaggio a pg. 178 / see mounting accessories to pg 178.

Dimmable Driver Version

version	code	For Panel	IP	Class
DALI 220 ÷ 240 V	SLE0141	36 W	IP20	Class II
PUSH 220 ÷ 240 V	SLE0142	36 W	IP20	Class II

1...10 V - Disponibile su richiesta / Dimming on demande

Emergency Kit

operation time	switching time	recharging time	minimum recessing hole (*)	IP	weight	code
1 hour	0,5 sec.	24 h.	Ø 75 mm.	IP20	0,43 kg	DRV9092
3 hours	0,5 sec.	24 h.	Ø 100mm.	IP20	0,88 kg	DRV9091

(*) per l'installazione in controsoffitto verificare la compatibilità con il foro di incasso; vedi dettagli a pagina 522
 (*) for installation in false ceiling check the compatibility with the recessing hole; see details to page 522

LED PANEL_HIGH PROTECTION IP65

□ ^{UPTO} 106lm/W ^{UPTO} UGR<19 IP65 L80/B20 50.000h.

Led Panel High Protection completa la linea Smart con la versione IP65, sia per la parte inferiore che per la parte superiore dell'apparecchio, rendendolo indicato per tutte le installazioni indoor dove è richiesto un elevato grado di impermeabilità e di pulizia dei corpi illuminanti.

Led Panel High Protection completes the Smart line with version IP65, which is suitable for both the lower and upper parts of the unit, making it suitable for all indoor installations where a high degree of waterproofing and clearness of lights is required.



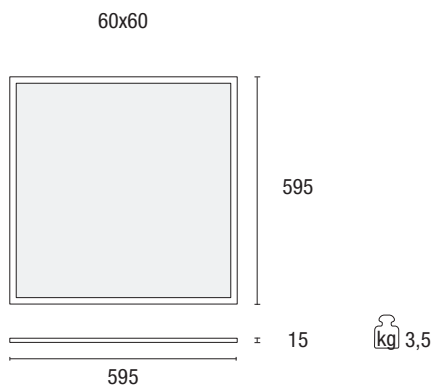

Fast Plug IP65 

Upside and downside IP65 

Driver IP65 

Optical Info p. 533

Led Panel High Protection IP65

CRI > 80

size	version	power	code	CCT	light output	UGR	optic	colore colour
60x60	On / Off	36 W	INC56442	3000 K	3400 lm	≤ 19	120°	white
	220 ÷ 240 V		INC56441	4000 K	3850 lm	≤ 19	120°	white

LED PANEL_TUNABLE

□ 2800÷6500 K ^{UPTO} UGR<19 L80/B20 50.000h.



Led Panel Tunable è in grado di ricreare la ciclicità della luce naturale e illuminare gli ambienti in modo dinamico, gestendo così il variare delle intensità luminose e della temperatura di colore nel tempo per garantire la condizione di massimo comfort visivo e fisiologico delle persone.

Led Panel Tunable is capable of recreating the cyclical nature of natural light and dynamically illuminates the surroundings so that the intensities and colour temperatures vary over time, to ensure maximum visual and physiological comfort for the inhabitants.

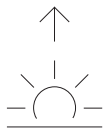

Early morning:
5000 K

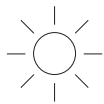

Late morning:
4000 K



Afternoon:
6000 K

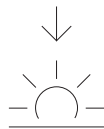

Sunset:
3000 K

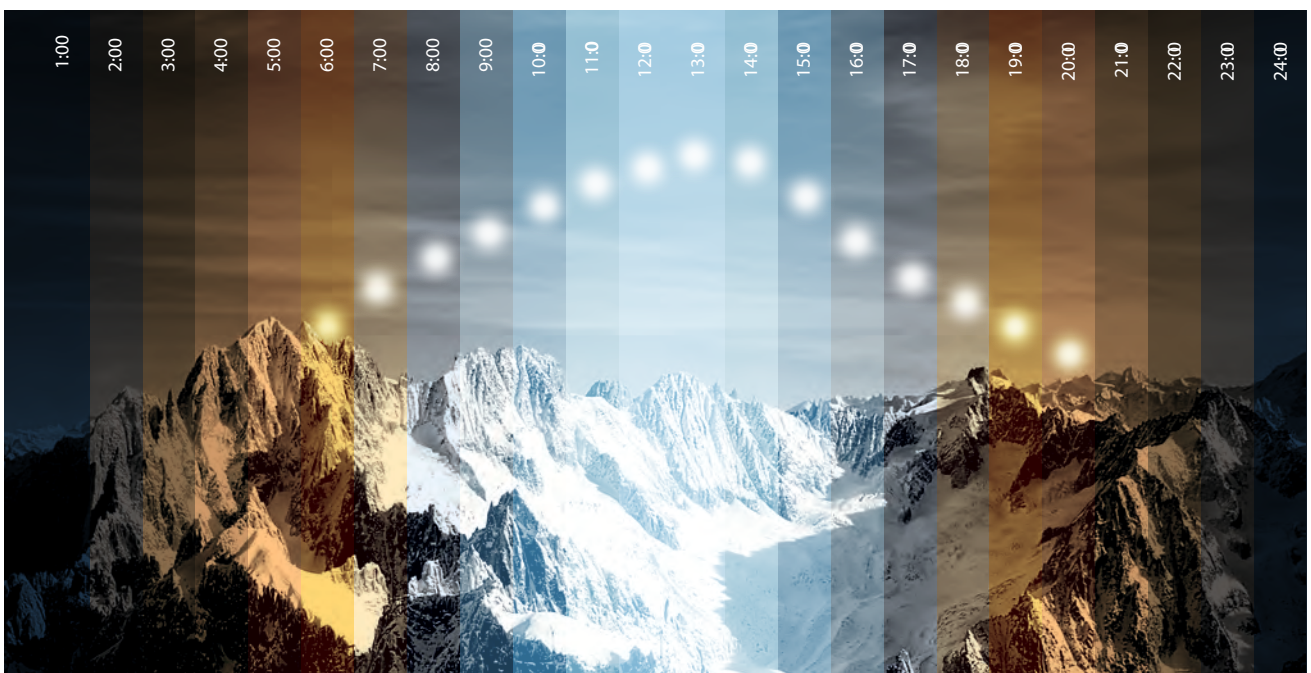

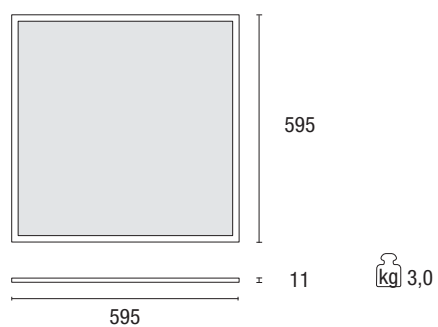

Optical Info p. 533

Led Panel Tunable

CRI > 80





size	version	power	code	CCT	light output	UGR	optic	colour
60x60	DALI (DT8) 220 ÷ 240 V	36 W	INC56542	2800 K ÷ 6500 K	3300 ÷ 4000 lm	≤ 19	120°	white

vedi accessori di fissaggio a pg. 178 / see mounting accessories to pg 178.

LED PANEL_ACCESSORIES

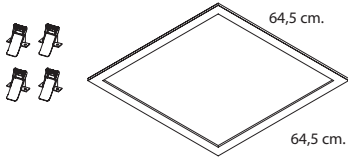
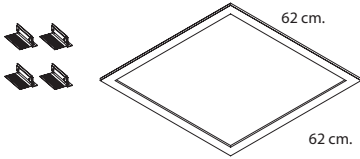
Accessori compatibile solo con Led Panel Smart / Microprismatic / Tunable
 Accessories suitable only with Led Panel Smart / Microprismatic / Tunable

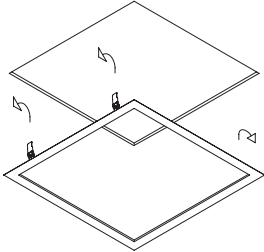
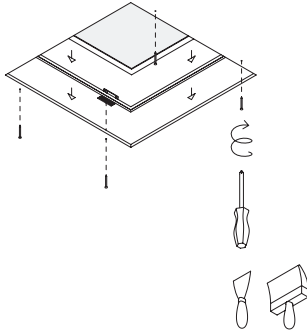
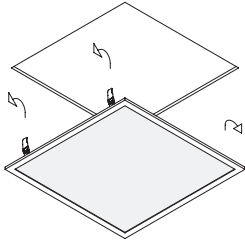
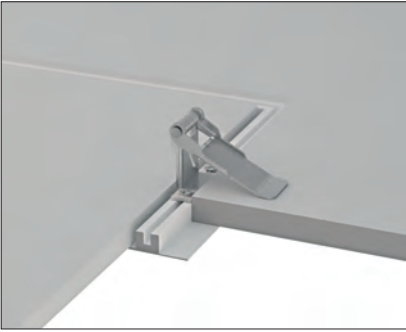

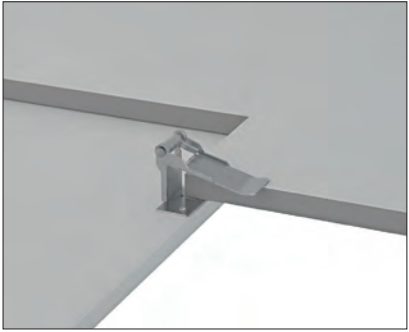
Kit Trimmed Recessed	Kit Trimless Recessed	Kit Semi Recessed <small>Non adatto per LED Panel IP65 / Not suitable for LED Panel IP65</small>	
<p style="text-align: center;">INC1283</p>  <p style="text-align: center;">For 60x60</p>	<p style="text-align: center;">INC1290</p>  <p style="text-align: center;">For 60x60</p>	<p style="text-align: center;">INC1280</p>  <p style="text-align: center;">For 30x30, 30x60, 60x60</p>	<p style="text-align: center;">INC1281</p>  <p style="text-align: center;">For 30x120, 60x120</p>
<p>Telaio bianco per installazione ad incasso completo di clips. <i>White frame for recessed panel installation with clips.</i></p> 	<p>Telaio bianco per incasso a filo in cartongesso con cornice a scomparsa completo di staffe. <i>White frame for trimless mounting on plasterboard with brackets and retractable frames.</i></p> 	<p>Molle per installazione a semincasso su pannello. Telaio non incluso. <i>Springs for recessed panel mounting. Frame not included.</i></p> 	
			
<p>Spessore cartongesso min. 5 mm. - max. 25 mm. <i>Plasterboard thickness min. 5 mm. - max. 25 mm.</i></p>	<p>Spessore cartongesso min. 9,5 mm. - max. 20 mm. <i>Plasterboard thickness min. 9,5 mm. - max. 20 mm.</i></p>	<p>Spessore cartongesso min. 9,5 mm. - max. 15 mm. <i>Plasterboard thickness min. 9,5 mm. - max. 15 mm.</i></p>	



Kit Ceiling Mounted

Non adatto per LED Panel IP65 / Not suitable for LED Panel IP65

INC1285



INC1286

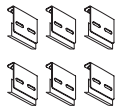

For

30x30, 30x60, 60x60

For

30x120, 60x120

Kit Pendant

Non adatto per LED Panel IP65 / Not suitable for LED Panel IP65

INC1291 INC1291D (*)

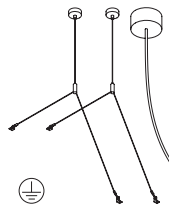

For

30x30, 30x60, 60x60

INC1292 INC1292D (*)

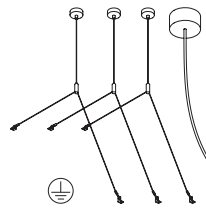

For

30x120, 60x120

(*) Versione DALI / (*) DALI version

Safety cables

Non adatto per LED Panel IP65 / Not suitable for LED Panel IP65

SOS50014

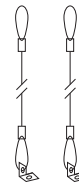

Staffe per installazione a soffitto non regolabile.

Fixed stirrups for ceiling installation.

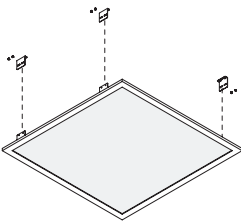

Installazione base a sospensione.

Suspension-based installations.

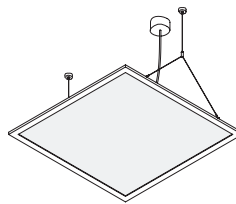

Cavi di sicurezza lunghezza 65 cm.

Safety cables length 65 cm.

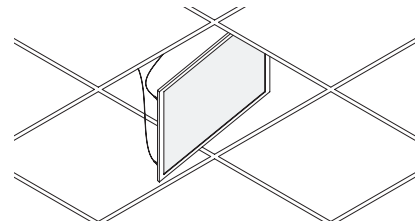

Distanza pannello dal soffitto 40 mm.
Distance from ceiling 40 mm.



Cavo in acciaio 1200 mm. / Steel cable 1200 mm.
Cavo rosone 3000 mm. / Canopy cable 3000mm



Cavi di sicurezza lunghezza 65 cm.
Safety cables length 65 cm.

PANEL BOX

I kit Panel Box consentono di installare i pannelli Backlit e i Led Panel a sospensione e a soffitto.

I Panel Box per Led Panel sono installabili anche a parete. I kit comprendono tutti gli elementi di fissaggio e di connessione necessari, sia a 3 poli che a 5 poli per impianti DALI, e vanno completati con la tipologia di pannello desiderata (non incluso). I Panel Box sono disponibili per tutte le misure delle serie Backlit e Led Panel.

Panel Box kit frames are suitable for Backlit and Led Panel, for pendant and ceiling mounting. Panel Box for Panel Led are available also for wall mounting. Panel Box kits are supplied with fixing or suspension elements as well as a 3-pole and 5-pole power cable for DALI systems. They must be completed with the chosen Backlit or Led Panel (not included).



Dimensione dei moduli / Modules sizing



30x30



30x60



60x60



62x62



30x120

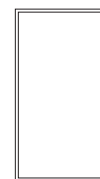

60x120

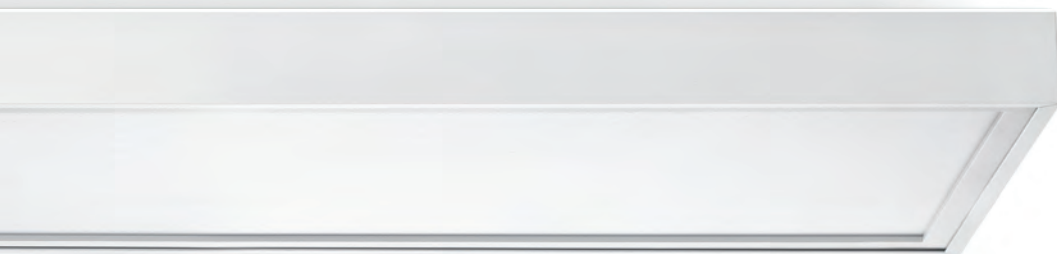

Cavi di sospensione da 3000 mm.
con sistema di regolazione fine.

3000 mm. suspension cables
with adjustment system.



PANEL BOX

per Backlit / *For Backlit*

per Led Panel / *For Led Panel*

High protection IP65

Backlit
Led Panel IP65

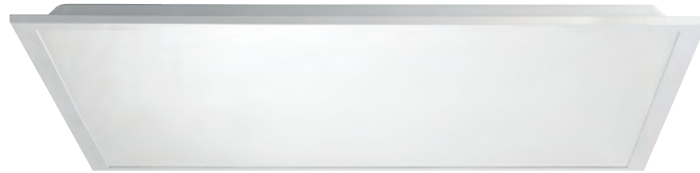

Panel Box

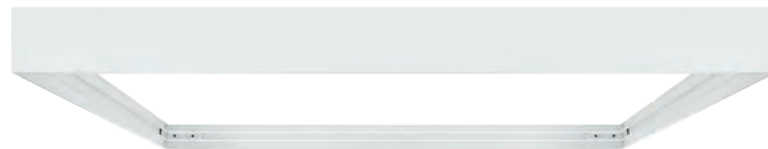

70 mm.

Panel Box Kit per Backlit e Led Panel IP65 / for Backlit and Led Panel IP65

mounting	version	size	code	colour
Soffitto Ceiling mounting	kit per Backlit / Led Panel IP65	60x60	PLA60122	white
	kit for Backlit / Led Panel IP65 On / Off	30x120	PLA60123	white
	Dimmable (Push - 1...10V - DALI)	60x120	PLA60124	white
Sospensione Pendant	kit per Backlit / Led Panel IP65	60x60	SOS60122	white
	kit for Backlit / Led Panel IP65 On / Off	30x120	SOS60123	white
		60x120	SOS60124	white
	kit per Backlit / Led Panel IP65	60x60	SOS60122D	white
	kit for Backlit / Led Panel IP65 Dimmable (Push - 1...10V - DALI)	30x120	SOS60123D	white
		60x120	SOS60124D	white

I kit Panel Box devono essere completati con il pannello Backlit o Led Panel IP65 prescelto da ordinare separatamente.
I kit per Backlit / Led Panel IP65 non sono idonei per l'installazione a parete.

The Box Panel kits must be completed with the selected Backlit or Led Panel IP65 to order separately.
Backlit / Led Panel IP65 kits are not suitable for wall-mounting installation.

PANEL BOX

per Led Panel / For Led Panel

Smart / Microprismatic / Tunable

Led Panel



Panel Box

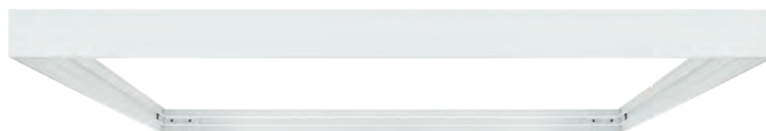

45 mm.

Panel Box Kit per Led Panel / Panel Box Kit for Led Panel

mounting	version	size	code	colour
Soffitto / Parete Wall or Ceiling mounting	kit per Led Panel / kit Led Panel On / Off Dimmable (Push - 1...10V - DALI)	30x30	PLA50120	white
		30x60	PLA50121	white
		60x60	PLA50122	white
		30x120	PLA50123	white
		60x120	PLA50124	white
		62x62	PLA50125	white
Sospensione Pendant	kit per Led Panel / kit Led Panel On / Off	30x30	SOS50120	white
		30x60	SOS50121	white
		60x60	SOS50122	white
		30x120	SOS50123	white
		60x120	SOS50124	white
		62x62	SOS50125	white
	kit per Led Panel / kit Led Panel Dimmable (Push - 1...10V - DALI)	30x30	SOS50120D	white
		30x60	SOS50121D	white
		60x60	SOS50122D	white
		30x120	SOS50123D	white
		60x120	SOS50124D	white
		62x62	SOS50125D	white

I kit Panel Box devono essere completati con il pannello Led Panel prescelto da ordinare separatamente.

The Box Panel kits must be completed with the selected Led Panel to order separately.



TRACK

03



I binari elettrificati su cui installare apparecchi d'illuminazione occupano un punto centrale nell'illuminazione tecnica contemporanea. La nostra proposta offre diverse soluzioni per impieghi diversificati. Modelli per illuminazione spot piuttosto che diffusa, si integrano con gestioni ON-OFF e dimmerazioni tecnologicamente avanzate. Grande attenzione nella scelta dei materiali, dei singoli componenti, delle elettroniche e dei software per la gestione di impianti semplici o complessi. Ospitalità, residenziale, office, retail, sono le principali direttrici su cui installiamo con successo i nostri prodotti.

The electrified tracks for lighting fixtures occupy a central point in contemporary technical lighting. Our proposal offers various solutions for diversified applications. Models for spotlighting as well as diffuse lighting integrate with technologically advanced ON-OFF and dimming systems. Great attention is given to the choice of materials, individual components, electronics, and software for managing simple or complex installations. Hospitality, residential, office, and retail sectors are the main directions where our products are successfully installed



Track4_Ceiling & Suspended

On-Off and Casambi

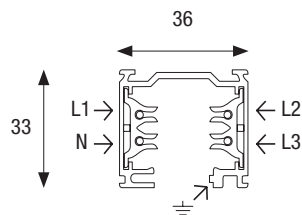

Binario trifase on-off. (*) 3-phase on-off track.

Description	White code	Black code
Track 100 cm	30203BV	30203NV
Track 200 cm	30200BV	30200NV
Track 300 cm	30223BV	30223NV

* Il binario può sopportare un carico di 10 kg utilizzando un kit di sospensione ogni 80 cm.
The track has a load capacity of 10 kg using one pendant kit every 80 cm.

Track 4 è un binario trifase a quattro conduttori; permette la realizzazione di impianti con tre accensioni separate utilizzando il conduttore neutro in comune; disponibile in colore bianco o nero, è utilizzabile per proiettori con accensione On/Off e Bluetooth Casambi ed è disponibile per installazioni a plafone o a sospensione.

Track 4 is a three-phase four conductors track; allows the construction of systems with three separate ignitions using the common neutral conductor; available in white or black, it can be used for projectors with On / Off and Bluetooth Casambi ignition and is available for ceiling or suspended installations.

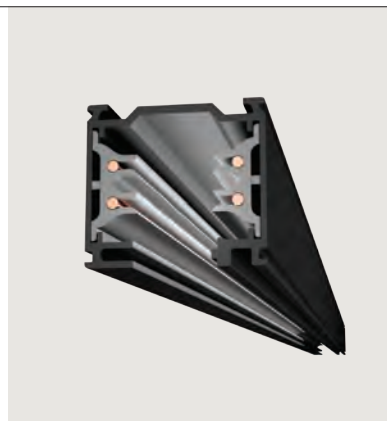

Adattatori / Adpter

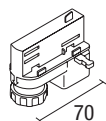

Description	colour	code
Electro/mechanical adapter 6A	white	30201BV
	black	30201NV

Basetta a soffitto / Case for ceiling mounting

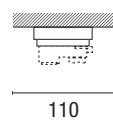

Description	colour	code
Suspension hook	white	TRK60407
	black	TRK50407

Terminale / Dead end



Description	colour	code
Dead end	white	30222BV
	black	30222NV

Alimentazione / Live-end



Description	colour	code
Left live-end	white	30204BV
	black	30204NV



Right live-end	white	30205BV
	black	30205NV

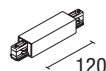

Central connector and straight joint	white	30207BV
	black	30207NV

Continuità della messa a terra Continuity of the earthing

Per una corretta installazione di tutti gli accessori che concorrono alla formazione di un impianto di binari trifase, è necessario garantire la continuità della linea di messa a terra tra ogni elemento. Il posizionamento dei conduttori di terra, infatti, deve essere consequenziale tra componente e componente.

For a correct installation of all the accessories in a three-phase track composition, the continuity of the earth connection between each element must be guaranteed. The earth conductors of each component must be positioned consistently.

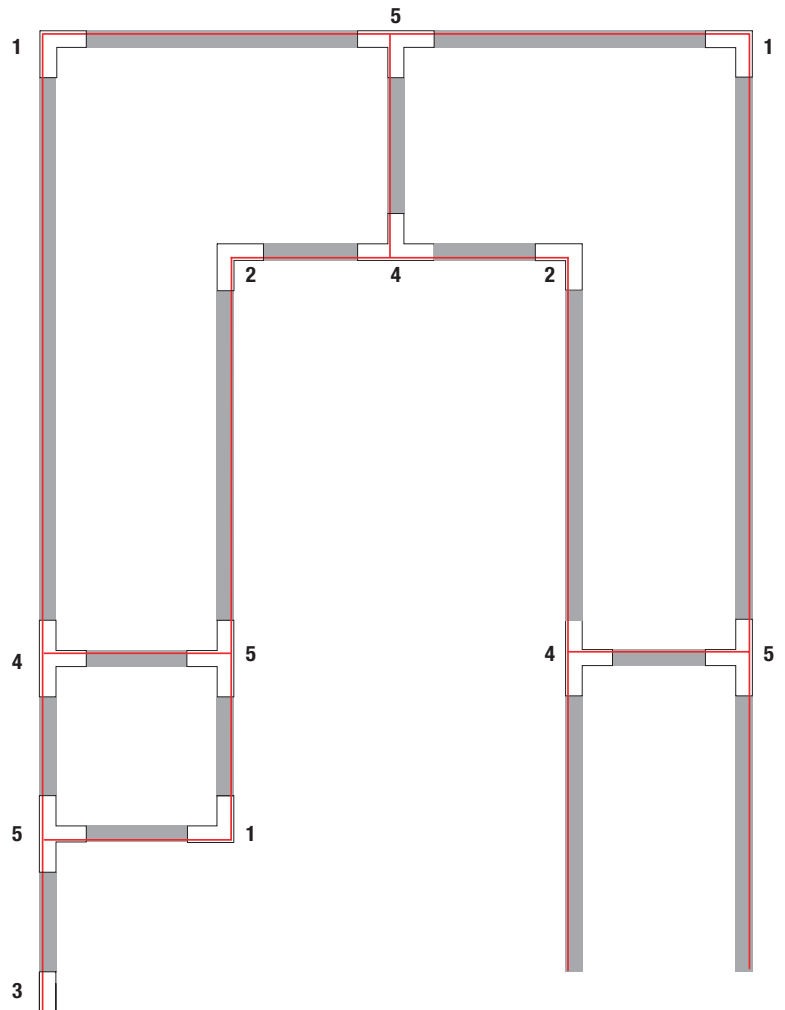
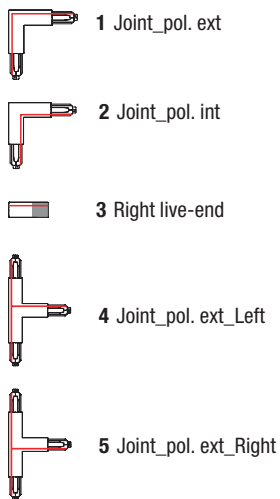

Soffitto / Ceiling



Description	code
Ceiling kit	30221

Sospensioni / Pendants

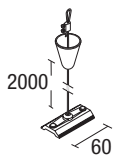

Description	colour	code
Suspension kit (2pcs) with steel wire 200 cm. and 6 cm. plate._on-off	white	30211BV
Suspension kit (2pcs) with steel wire 200 cm. and 6 cm. plate._on-off	black	30211NV

Rosoni / Canopy

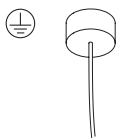

Description	colour	code
Canopy 300 cm_On / Off	white	S0S50018

Giunzioni / Joints

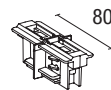

Description	colour	code
Electrical straight joint with stop	white	30210BV
	black	30210NV

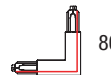

L Joint_pol. ext	white	30216BV
	black	30216NV

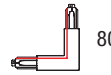

L Joint_pol. int	white	30215BV
	black	30215NV

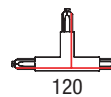

T Joint_pol. ext_Right	white	30219BV
	black	30219NV

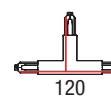

T Joint_pol. ext_Left	white	30218BV
	black	30218NV

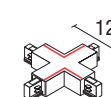

X Joint	white	30220BV
	black	30220NV



Flexible joint	white	30213BV
	black	30213NV

Track6 Digital_Ceiling & Suspended

DALI

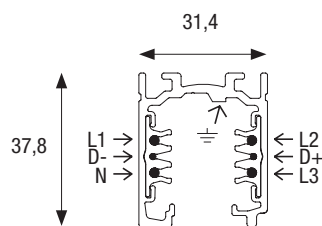

Binario trifase DALI
3-phase DALI track.

Description	White	Black
Track 100 cm	60203BS	60203NS
Track 200 cm	60200BS	60200NS
Track 300 cm	60223BS	60223NS

Il binario può sopportare un carico di 25 kg utilizzando un kit di sospensione ogni 90 cm. The track has a load capacity of 25 kg using one pendant kit every 90 cm.

Track 6 Digital è un binario trifase a sei conduttori; permette la realizzazione di impianti DALI con tre accensioni separate utilizzando il conduttore neutro in comune e due conduttori di segnale D+/D-; disponibile in colore bianco o nero, è utilizzabile con proiettori DALI ed è disponibile per installazioni a plafone o a sospensione. Lo stesso binario Track 6 DALI Multi è utilizzabile anche con le versioni digitali Bluetooth Casambi.

Track 6 Digital is a three-phase six-conductor track; allows to install DALI systems with three separate ignitions using the common neutral conductor and also two D + / D- signal conductors; available in white or black, it can be used with DALI spotlights and is available for ceiling or suspended installations. The same Track 6 DALI Multi track can also be used with the digital Bluetooth Casambi.



Adattatori / Adppter

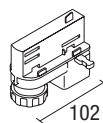

Description	colour	code
Electro/mechanical adapter 6A	white	60201BS
	black	60201NS

Terminale / Dead end



Description	colour	code
End cap with locking screw	white	60222BS
	black	60222NS

Alimentazione / Live-end

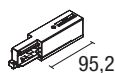

Description	colour	code
End feed_right_DALI	white	60205BS
	black	60205NS

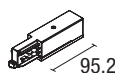

Description	colour	code
End feed_left_DALI	white	60204BS
	black	60204NS

Soffitto / Ceiling



Description	colour	code
Ceiling bracket	white	60221BS
	black	60221NS

Sospensioni / Pendants

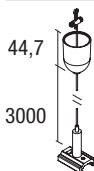

Description	colour	code
Complete suspension kits 300cm_DALI	white	60211BS
	black	60211NS

Rosoni / Canopy

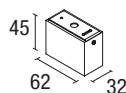

Description	colour	code
Canopy for ceiling mounting		
Wiring cable not included_DALI	white	60212BS

Accessori / Accessories



Description	colour	code
Suspension hook	white	60227BS
	black	60227NS

Continuità della messa a terra Continuity of the earthing

Per una corretta installazione di tutti gli accessori che concorrono alla formazione di un impianto di binari trifase, è necessario garantire la continuità della linea di messa a terra tra ogni elemento. Il posizionamento dei conduttori di terra, infatti, deve essere consequenziale tra componente e componente.

For a correct installation of all the accessories in a three-phase track composition, the continuity of the earth connection between each element must be guaranteed. The earth conductors of each component must be positioned consistently.

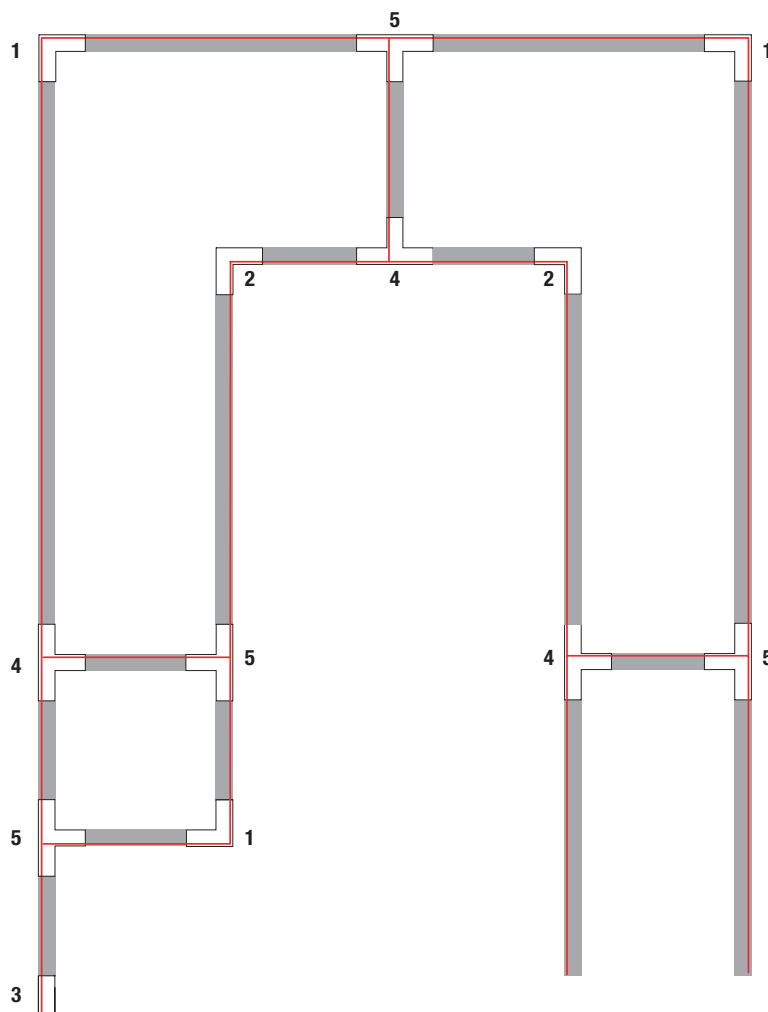
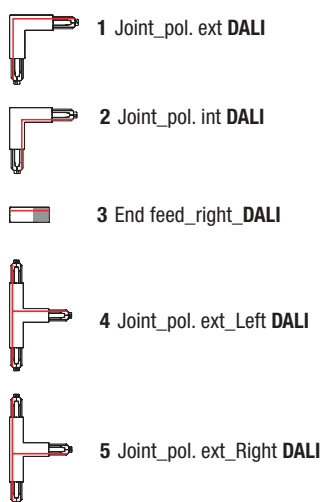

Giunzioni / Joints

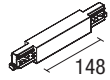
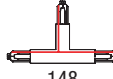
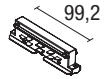
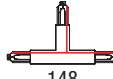
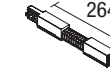
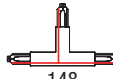
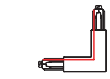
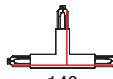
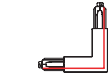
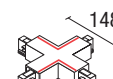
	Description	colour	code		Description	colour	code
	I Joint_DALI	white	60207BS		T Joint_pol. int_Left_DALI	white	60218BS
		black	60207NS			black	60218NS
	Joining connector_DALI	white	60210BS		T Joint_pol. int_Right_DALI	white	60219BS
		black	60210NS			black	60219NS
	Adjustable corner_DALI	white	60213BS		T Joint_pol. ext_Left_DALI	white	60224BS
		black	60213NS			black	60224NS
	L Joint_pol. int_DALI	white	60215BS		T Joint_pol. ext_Right_DALI	white	60225BS
		black	60215NS			black	60225NS
	L Joint_pol. ext_DALI	white	60216BS		X Joint_DALI	white	60220BS
		black	60216NS			black	60220NS

TRACK LIGHTING



SINERGY

p.204

18_28 W

2700_3000_4000 K

15°_24°_38°_65°

On/Off_Dali
Dali "Ghost"_Casambi

White_Black

SLIM

p.192

12_20_33 W

3000_4000 K

15°_24°_38°_55°

On/Off_Dali
Dali "Ghost"_Casambi

White_Black_Sand_
Silver_Tobacco

SKA

p.200

12_25_33_42 W

3000_4000 K

15°_36°_55°

On/Off_Dali

White_Black

EXTREME

p.208

12_18 W

2700_3000_4000 K

15°_24°_38°_55°_120°

On/Off_Dali_
Dali "Ghost"_Casambi

White_Black_Rose Gold_
Bronze_Titanium_Satin Steel

DAY

p.216

1000 mm.

30 W

3000_4000 K

120°

On/Off

White_Black

MAYA

p.212

600_1100_1700_2200 mm.

12_24_36_48 W

2700_3000_4000 K

120°_Microprismatic_50°_80°

On/Off_Dali_Casambi

White_Black

SLIM_Track



Il design pulito ed essenziale è il primo fattore di successo dei proiettori serie Slim. Il catalogo 2023 introduce sostanziali novità che ampliano i campi di utilizzo del prodotto. Ai modelli CLASSIC, con alimentatore sul corpo lampada si affiancano le versioni EVO. Questa novità introduce colori aggiuntivi ed ulteriori possibilità nella scelta dei sistemi di controllo DALI. La luce emessa si distingue per l'ottima diffusione del fascio e per l'elevata qualità cromatica (CRI > 90 / MacAdam < 3). Queste caratteristiche rendono SLIM particolarmente adatto all'illuminazione di negozi, aree espositive e di tutti gli ambienti dove la resa del colore e la pulizia dei fasci luminosi rivestono primaria importanza. Le lenti ottiche sono di tipo semidiffusivo e l'abbagliamento diretto è totalmente controllato grazie alla profonda schermatura con un cut-off di 36° che caratterizza il frontale. SLIM è disponibile in versione On/Off, DALI, e Casambi.

The clean and essential design is the primary factor for the success of the Slim series projectors. The 2023 catalog introduces substantial innovations that expand the fields of product usage. In addition to the CLASSIC models with the power supply on the lamp body, the EVO versions are now available. This new addition introduces additional colors and further possibilities in choosing DALI control systems. The emitted light stands out for its excellent beam diffusion and high chromatic quality (CRI > 90 / MacAdam < 3). These features make SLIM particularly suitable for lighting shops, exhibition areas, and all environments where color rendering and the cleanliness of light beams are of primary importance. The optical lenses are of the semi-diffuse type, and direct glare is completely controlled thanks to the deep shielding with a 36° cut-off that characterizes the front. SLIM is available in On/Off, DALI, and Casambi versions.



+ SLIM Ceiling/Wall pag 248



EXTENDED COLLECTION

+ SLIM GU10 Ceiling/Wall pag 251



+ SLIM Recessed pag 072



+ SLIM GU10 Semirecessed pag 075

SLIM_Classic

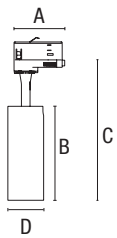

Power	Control	Lumen output	Source	Product dimension				Weight	* code to complete
				A	B	C	D		
12 W	On/Off	1196 lm	CoB LED	70 mm	134 mm	198 mm	52 mm	0,34 kg	TA-AA ● □ NF ▼
20 W	On/Off	2190 lm	CoB LED	70 mm	170 mm	217 mm	52 mm	0,52 kg	TA-AC ● □ NF ▼
33 W	On/Off	3320 lm	CoB LED	70 mm	165 mm	222 mm	72 mm	0,73 kg	TA-AE ● □ NF ▼

⊕ 220÷240Vac | IP20

CRI>90 | RG1 | SDCM<3
UP to 110 lm/W | L80/B20 50.000 h.

Lumen output values: luminaire luminous flux at 4000 K - optics 38°

Optical Info p. 533

* Select your option

GCT	●	Optic	□	Colour	▼
3000 K	2	15°	1	White	W
4000 K	3	24°	2	Black	B
		38°	3		
		55°	4		



SLIM_EVO Sand

SLIM_evo

12W

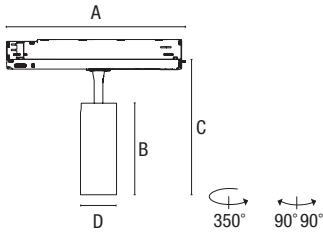

Control	Lumen output	Product dimension				Weight	*code to complete
		A	B	C	D		
On Off	1255 lm	170 mm	134 mm	199 mm	52 mm	0,37 kg	TB-AA NF
DALI		253 mm	134 mm	196 mm	52 mm	0,34 kg	TB-AA DA
Casambi		234 mm	134 mm	196 mm	52 mm	0,39 kg	TB-AA CA

220÷240Vac | IP20

CRI>90 | RG1 | SDCM<3
UP to 105 lm/W | L80/B20 80.000 h.

Lumen output values: luminaire luminous flux at 4000 K - optics 38°

20W

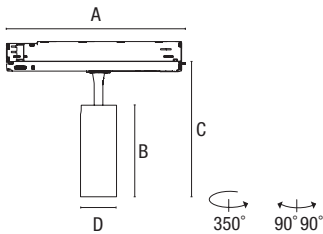

Control	Lumen output	Product dimension				Weight	*code to complete
		A	B	C	D		
On Off	2280 lm	170 mm	170 mm	219 mm	55 mm	0,56 kg	TB-AC NF
DALI		253 mm	170 mm	215 mm	55 mm	0,59 kg	TB-AC DA
Casambi		234 mm	170 mm	215 mm	55 mm	0,58 kg	TB-AC CA

220÷240Vac | IP20

CRI>90 | RG1 | SDCM<3
UP to 114 lm/W | L80/B20 80.000 h.

Lumen output values: luminaire luminous flux at 4000 K - optics 38°

33W

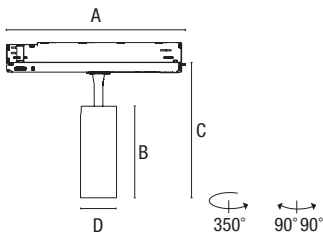

Control	Lumen output	Product dimension				Weight	*code to complete
		A	B	C	D		
On Off	3486 lm	170 mm	165 mm	223 mm	72 mm	0,70 kg	TB-AE NF
DALI		253 mm	165 mm	220 mm	72 mm	0,73 kg	TB-AE DA
Casambi		234 mm	165 mm	220 mm	72 mm	0,72 kg	TB-AE CA

220÷240Vac | IP20

CRI>90 | RG1 | SDCM<3
UP to 106 lm/W | L80/B20 80.000 h.

Lumen output values: luminaire luminous flux at 4000 K - optics 55°

Optical Info p. 533

* Select your option

Colour Adapter	CCT	Optic	Colour
White W	2700 K 1	15° 1	White W
Black B	3000 K 2	24° 2	Black B
	4000 K 3	38° 4	Sand V
		55° 5	Silver G
			Tobacco O

SLIM_evo

12W

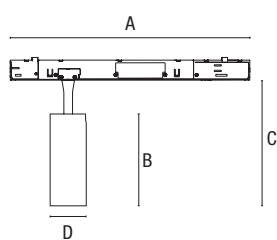

Control	Lumen output	Product dimension				Weight	*code to complete	
		A	B	C	D			
DALI "Ghost"	1255 lm	345 mm	134 mm	181 mm	52 mm	0,37 kg	TB-AA + ● □ DT ▼	
⊕ 220÷240Vac IP20							CRI>90 RG1 SDCM<3 UP to 105 lm/W L80/B20 80.000 h. Lumen output values: luminaire luminous flux at 4000 K - optics 38°	

20W

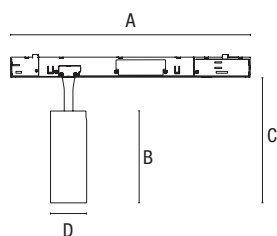

Control	Lumen output	Product dimension				Weight	*code to complete	
		A	B	C	D			
DALI "Ghost"	2280 lm	345 mm	170 mm	201 mm	55 mm	0,56 kg	TB-AC + ● □ DT ▼	
⊕ 220÷240Vac IP20							CRI>90 RG1 SDCM<3 UP to 114 lm/W L80/B20 80.000 h. Lumen output values: luminaire luminous flux at 4000 K - optics 38°	

33W

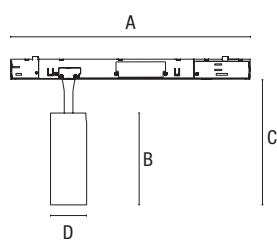

Control	Lumen output	Product dimension				Weight	*code to complete	
		A	B	C	D			
DALI "Ghost"	3486 lm	345 mm	165 mm	206 mm	72 mm	0,69 kg	TB-AE + ● □ DT ▼	
⊕ 220÷240Vac IP20							CRI>90 RG1 SDCM<3 UP to 106 lm/W L80/B20 80.000 h. Lumen output values: luminaire luminous flux at 4000 K - optics 55°	

Optical Info p. 533



* Select your option

Colour Adapter +	CCT ●	Optic □	Colour ▼
White W	2700 K 1	15° 1	White W
Black B	3000 K 2	24° 2	Black B
	4000 K 3	38° 4	Sand V
		55° 5	Silver G
			Tobacco 0

SLIM_GU10

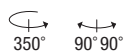
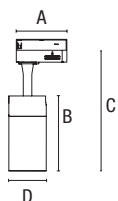
GU10



Power	Source	Lumen output	Product dimension				Weight	* code to complete
			A	B	C	D		
1x max 50 W	GU10	/	74 mm	110 mm	177 mm	55 mm	0,29 kg	TC-A  
⊕ 220÷240Vac IP20								

* Select your option

Colour Adapter 

White	W
Black	B

Colour 

White	W
Black	B



SKA_Track



I proiettori della serie SKA sono particolarmente indicati per l'illuminazione degli ambienti commerciali come i negozi e gli store. Le elevate prestazioni consentono di illuminare adeguatamente le superfici espositive e gli ambienti ove si richiede affidabilità e qualità della luce. I proiettori della serie Ska montano componenti selezionati (prime brand) e LED con elevate qualità cromatiche (CRI > 90 e SDCM < 3). Il flusso luminoso è ottimizzato da riflettori con alto rendimento a garanzia della massima efficienza e flessibilità dell'impianto. L'apparecchio è configurabile nella versione On / Off / DALI / Casambi. Disponibile anche versioni parete-soffitto nelle potenze 25 e 33W

SKA series projectors are particularly suitable for commercial lighting such as shops and stores. The high performance allows to adequately illuminate the exhibition surfaces and environments where reliability and quality of light are required. The projectors of the Ska series have selected components (prime brands) and LEDs with high color qualities (CRI > 90 and SDCM < 3). The luminous flux is optimized by reflectors with high efficiency to ensure maximum efficiency and flexibility of the system. The luminaire can be configured On-Off / DALI / Casambi version. Wall & ceiling versions available in 25 and 33W wattages.





**EXTENDED
COLLECTION**

SKA_Track

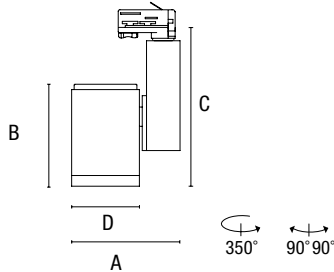

Power	Lumen output	Product dimension				Weight	*code to complete
		A	B	C	D		
12 W	1265 lm	103 mm	92 mm	190 mm	65 mm	0,60 kg	TD-AA ● □ :: ▼
25 W	2585 lm	128 mm	123 mm	190 mm	82 mm	0,85 kg	TD-AD ● □ :: ▼
33 W	3480 lm	152 mm	143 mm	230 mm	95 mm	1,20 kg	TD-AE ● □ :: ▼
42 W	4305 lm	177 mm	180 mm	255 mm	120 mm	2,00 kg	TD-AF ● □ :: ▼



⊕ 220÷240Vac | IP20

CRI>90 | RG1 | SDCM<3

UP to 106 lm/W | L80/B20 50.000 h.

Lumen output values: luminaire luminous flux at 4000 K - optics 36°

Accessories

	Description	Colour	Weight	12W	25W	33W	42W
	Honeycomb grid		0,02 kg	TRK60353	TRK60358	TRK60363	TRK60367
	Barn doors		0,03 kg	/	TRK60359	TRK60364	TRK60368
	Ex snot	White	0,08 Kg	TRK60352	TRK60357	/	/
		Black		TRK50352	TRK50357	/	/

Optical Info p. 533

* Select your option

CCT	●	Optic	□	Control	⋮	Colour	▼
3000 K	2	15°	1	On/Off	NF	White	W
4000 K	3	36°	3	DALI	DA	Black	B
		55°	4				



SINERGY_Track



Efficienza ed estetica ai massimi livelli sono i plus del proiettore SINERGY. Un design attento e minimale, in linea con le richieste del mercato, è associato a scelte tecniche di eccellenza.

L'apparecchio si pone ai vertici di categoria nel rapporto flussi luminosi e dimensioni. Perfetto controllo delle temperature, LED di eccellenza assoluta, ottiche performanti, sistemi di alimentazione e controlli evoluti, posizionano l'apparecchio nella fascia alta delle scelte progettuali. SINERGY, frutto di un concreto lavoro di ricerca e sviluppo, si candida all'impiego nelle installazioni più prestigiose attente al mix tra valore estetico ed efficientamento energetico.

Efficiency and aesthetics at the highest levels are the strengths of the SINERGY projector. A thoughtful and minimal design, in line with market demands, is combined with excellent technical choices. The device ranks at the top of its category in terms of luminous output and dimensions. Perfect temperature control, top-notch LEDs, high-performance optics, advanced power systems, and controls position the device in the high-end range of design choices. SINERGY, the result of concrete research and development, is suitable for use in the most prestigious installations that prioritize the blend of aesthetic value and energy efficiency.





EXTENDED COLLECTION

+ SINERGY Semirecessed pag 082



SINERGY_Track



18 W

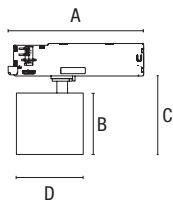

Control	Lumen output	Product dimension				Weight	* code to complete
		A	B	C	D		
On Off	1967 lm	170 mm	80 mm	116 mm	87 mm	0,53 kg	TE-AB + ● □ NF ▼
DALI	1967 lm	253 mm	80 mm	113 mm	87 mm	0,56 kg	TE-AB + ● □ DA ▼
DALI "Ghost"	1967 lm	345 mm	80 mm	99 mm	87 mm	0,53 kg	TE-AB + ● □ DT ▼
Casambi	1967 lm	234 mm	80 mm	113 mm	87 mm	0,55 kg	TE-AB + ● □ CA ▼

⊕ 220÷240Vac | IP20

CRI>90 | RG1 | SDCM<3
UP to 109 lm/W | L80/B20 80.000 h.
Lumen output values: luminaire luminous flux at 4000 K - optics 38°

28 W

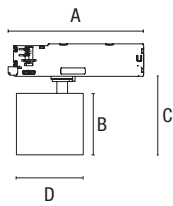

Control	Lumen output	Product dimension				Weight	* code to complete
		A	B	C	D		
On Off	3060 lm	170 mm	80 mm	116 mm	87 mm	0,53 kg	TE-AD + ● □ NF ▼
DALI	3060 lm	253 mm	80 mm	113 mm	87 mm	0,56 kg	TE-AD + ● □ DA ▼
DALI "Ghost"	3060 lm	345 mm	80 mm	99 mm	87 mm	0,53 kg	TE-AD + ● □ DT ▼
Casambi	3060 lm	234 mm	80 mm	113 mm	87 mm	0,55 kg	TE-AD + ● □ CA ▼

⊕ 220÷240Vac | IP20

CRI>90 | RG1 | SDCM<3
UP to 109 lm/W | L80/B20 80.000 h.
Lumen output values: luminaire luminous flux at 4000 K - optics 38°

Accessories

Description	Weight	18W		28W
		18W	28W	28W
 Honeycomb grid	0,02 kg	RTL28016	RTL28016	RTL28016

Optical Info p. 534

* Select your option

Colour Adapter	CCT	Optic	Colour
White +	2700 K ●	15° □	White ▼
Black +	3000 K ●	24° □	Black ▼
	4000 K ●	38° □	
		65° □	



EXTREME _Track

La proposta EXTREME trova la sua principale applicazione nelle soluzioni con adattatore per binario. Funzionalità ed estetica si esaltano nelle diverse configurazioni. L'apparecchio, totalmente orientabile sull'asse verticale ed orizzontale, massimizza il suo impiego e le prestazioni grazie alle diverse ottiche, le possibilità di gestione e regolazione delle elettroniche e le temperature colore del Led a scelta tra 2700K, 3000K e 4000K. I colori dell'anello in alluminio tornito, ottenuti con trattamento speciale, qualificano marcatamente gli ambienti in cui vengono installati.

The EXTREME proposal finds its main application in solutions with a track adapter. Functionality and aesthetics are enhanced in various configurations. The fixture, fully adjustable on both the vertical and horizontal axes, maximizes its usage and performance thanks to different optics, electronic management and adjustment options, and selectable LED color temperatures of 2700K, 3000K, and 4000K. The colors of the aluminum ring, achieved through a special treatment, significantly enhance the environments in which they are installed.

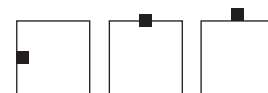

+ EXTREME Recessed pag 076



EXTENDED COLLECTION



+ EXTREME Ceiling pag 240

EXTREME_Track



12 W

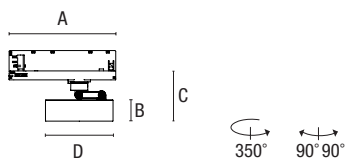

Control	Lumen output	Product dimension				Weight	*code to complete
		A	B	C	D		
On Off	1447 lm	170 mm	32 mm	77 mm	103 mm	0,48 kg	TF-AA NF
DALI	1447 lm	253 mm	32 mm	74 mm	103 mm	0,51 kg	TF-AA DA
DALI "Ghost"	1447 lm	345 mm	32 mm	60 mm	103 mm	0,47 kg	TF-AA DT
Casambi	1447 lm	234 mm	32 mm	74 mm	103 mm	0,50 kg	TF-AA CA

220÷240Vac | IP20

CoB LED | CRI>90 | RG1 | SDCM<3
UP to 104 lm/W | L80/B20 80.000 h.

Lumen output values: luminaire luminous flux at 4000 K - optics 38°

18 W

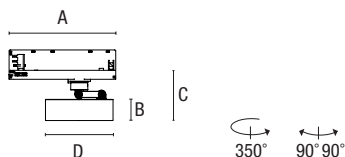

Control	Lumen output	Product dimension				Weight	*code to complete
		A	B	C	D		
On Off	1852 lm	170 mm	32 mm	77 mm	103 mm	0,48 kg	TF-AB NF
DALI	1852 lm	253 mm	32 mm	74 mm	103 mm	0,51 kg	TF-AB DA
DALI "Ghost"	1852 lm	345 mm	32 mm	60 mm	103 mm	0,47 kg	TF-AB DT
Casambi	1852 lm	234 mm	32 mm	74 mm	103 mm	0,50 kg	TF-AB CA

220÷240Vac | IP20

CRI>90 | RG1 | SDCM<3
UP to 103 lm/W | L80/B20 80.000 h.

Lumen output values: luminaire luminous flux at 4000 K - optics 38°

Optical Info p. 534

*** Select your option**

Colour Adapter	CCT	Optic	Colour Ring
White W	2700 K 1	15° 1	White W
Black B	3000 K 2	24° 2	Black B
	4000 K 3	38° 3	Rose Gold S
		55° 4	Bronze Z
			Titanium T
			Satin steel A

EXTREME_Track



12 W

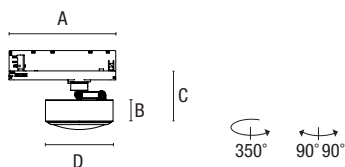

Control	Lumen output	Product dimension				Weight	*code to complete
		A	B	C	D		
On Off	1228 lm	170 mm	47 mm	92 mm	103 mm	0,61 kg	TF-AA NF
DALI	1228 lm	253 mm	47 mm	88 mm	103 mm	0,63 kg	TF-AA DA
DALI "Ghost"	1228 lm	345 mm	47 mm	74 mm	103 mm	0,60 kg	TF-AA DT
Casambi	1228 lm	234 mm	47 mm	88 mm	103 mm	0,62 kg	TF-AA CA

220÷240Vac | IP20

CoB LED | CRI>90 | RG1 | SDCM<3
UP to 88 lm/W | L70/B10 60.000 h.

Lumen output values: luminaire luminous flux at 4000 K

18 W

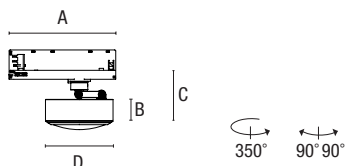

Control	Lumen output	Product dimension				Weight	*code to complete
		A	B	C	D		
On Off	1426 lm	170 mm	47 mm	92 mm	103 mm	0,61 kg	TF-AB NF
DALI	1426 lm	253 mm	47 mm	88 mm	103 mm	0,63 kg	TF-AB DA
DALI "Ghost"	1426 lm	345 mm	47 mm	74 mm	103 mm	0,60 kg	TF-AB DT
Casambi	1426 lm	234 mm	47 mm	88 mm	103 mm	0,62 kg	TF-AB CA

220÷240Vac | IP20

CRI>90 | RG1 | SDCM<3
UP to 80 lm/W | L70/B10 60.000 h.+

Lumen output values: luminaire luminous flux at 4000 K

Optical Info p. 534

* Select your option

Colour Adapter	CCT	Optic	Colour Ring
White W	2700 K 1	120° 5	White W
Black B	3000 K 2		Black B
	4000 K 3		Rose Gold S
			Bronze Z
			Titanium T
			Satin steel A

MAYA_Track



I prodotti della serie MAYA sono disponibili anche per applicazione binario. Quattro modelli standard: 600, 1100, 1700 e 2200. Aumenta la flessibilità del sistema che permette l'impiego anche in installazioni complesse. La nostra proposta prevede modelli ON-OFF e DALI, molteplici colori della scocca, a scelta emissioni diffuse (50°, 80°, 120° e microprismatico).

The products of the MAYA series are also available for track application. Four standard models: 600, 1100, 1700, and 2200. The system's flexibility increases, allowing for use in complex installations as well. Our proposal includes both ON-OFF and DALI models, with multiple colors available for the housing. You can choose between diffuse emissions (50°, 80°, 120° - microprismatico).



✦ MAYA Pendant pag 276



✦ MAYA Ceiling pag 226



✦ MAYA Wall pag 332



✦ MAYA Recessed pag 062

EXTENDED COLLECTION

MAYA_Track

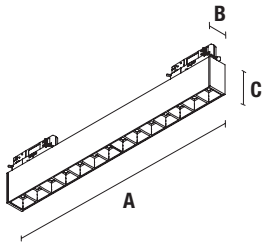

Model	Power	Lumen output	Product dimension			*code to complete
			A	B	C	
600	12 W	1518 lm	568 mm	42 mm	72 mm	TG-AAA ▼ ■ △ □ ●
1100	24 W	3036 lm	1127 mm	42 mm	72 mm	TG-ABG ▼ ■ △ □ ●
1700	36 W	4554 lm	1687 mm	42 mm	72 mm	TG-ACH ▼ ■ △ □ ●
2200	48 W	6072 lm	2247 mm	42 mm	72 mm	TG-ADI ▼ ■ △ □ ●

⊕ 220÷240Vac | IP40

UP to 127 lm/W | UP to UGR≥16 | L80/B20 80.000 h. | CRI>90 | UP to RG0 | SDCM<3
Lumen output values: luminaire luminous flux at 4000 K - optics 50°

Optical Info p. 528

*** Select your option**

Adapter color ▼	CCT ■	Optic △	Control □	Structure Colour ●
White W	2700 K 1	120° 5	On/Off NF	White WW
Black B	3000 K 2	Micro M	DALI DA	Black BB
	4000 K 3	50° White N	Casambi CA	
		50° Black O		
		80° White P		
		80° Black Q		



DAY

Day è la soluzione Ideale per illuminare con luce diffusa i negozi e le aree commerciali sostituendo le tradizionali lampade fluorescenti lineari. Può essere utilizzato in combinazione con i proiettori Ska e Slim e, grazie agli adattatori eurostandard inclusi, può essere installato sui binari trifase della serie Track. È equipaggiato con led in linea abbinati ad uno schermo diffondente in modo da ottenere un'illuminazione diffusa che ammorbidisce le ombre tipiche della luce dei proiettori.



Day is the ideal solution for the lighting of shops and commercial areas with diffused light, replacing traditional linear fluorescent lamps. In accordance with Ska and Slim projectors and thanks to the included eurostandard adapters, it can be installed on the three-phase tracks series. Equipped with in-line LEDs, combined with a diffusing screen, to obtain a diffused lighting mitigating the shadow effect typical of the projectors light.

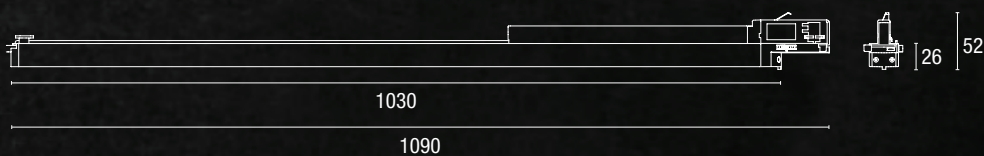
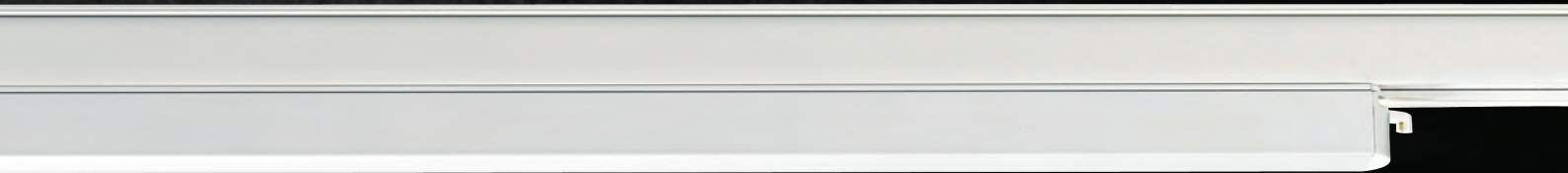

Optical Info p. 534

Version	Power	Optic	Code	light temperature	light output	Weight	colour
On / Off	28 W	120°	TRK80502	3000 K	2640 lm	0,75 kg	white
			TRK80503	4000 K	2820 lm	0,75 kg	white
			TRK80502N	3000 K	2640 lm	0,75 kg	black
			TRK80503N	4000 K	2820 lm	0,75 kg	black

⊕ 220÷240Vac | IP20

CRI>80 | RG0
UP to 94 lm/W | L80/B20 50.000 h.



CEILING

04

I N D E X



Karma_p.220



Maya_p.226

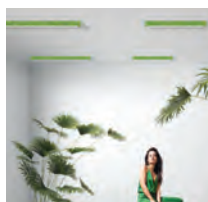

Maya Mini_p.234



Extreme_p.240



Ska_p.244



Slim_p.248



Hoop_p.252



Corona_p.253



Penny_p.254



Kart_p.256



Bike_p.257



Young_p.258



Play_p.260



Dama_p.262



Urano_p.264

KARMA_Ceiling



Karma nella soluzione soffitto permette installazioni di qualità e potenza luminosa. L'apparecchio è disponibile in diverse misure, colori e gestioni elettroniche che prevedono ON-OFF, DALI, Push, Casambi. Si possono scegliere elementi da installare in versione stand alone oppure configurazioni, anche complesse, che prevedono linee continue ed angoli. Un configuratore on line permette la selezione del prodotto desiderato in maniera rapida e semplice.

Karma in the ceiling solution allows quality installations and light output. The unit is available in different sizes, colors and electronic controls that include ON-OFF, DALI, Push, Casambi. You can choose elements to be installed in stand alone version or configurations, even complex, that provide continuous lines and angles. An online configurator allows quick and easy selection of the desired product.



✦ KARMA Pendant pag 268



✦ KARMA Recessed pag 056



✦ KARMA Wall pag 326

**EXTENDED
COLLECTION**

Karma_Ceiling

Installation

Karma si installa in fila continua grazie al particolare giunto meccanico che, grazie alle sue viti di regolazione, permette di allineare perfettamente i singoli moduli strutturali. Agendo sulle viti di regolazione dei giunti meccanici si allineano i moduli strutturali fra loro, ottenendo così una migliore installazione. Gli appositi fast-plug garantiscono la connessione elettrica fra i moduli strutturali precablati senza bisogno di utilizzare utensili.

Karma can be installed in a continuous line thanks to the mechanic joint that, thanks to its adjustment screws, allows the individual rail modules to be perfectly aligned. Acting on the adjustment screws of the mechanical joints and aligning the rail modules together, thus obtaining a better installation. The special fast-plugs require the electrical connection between pre-wired modules without tools.

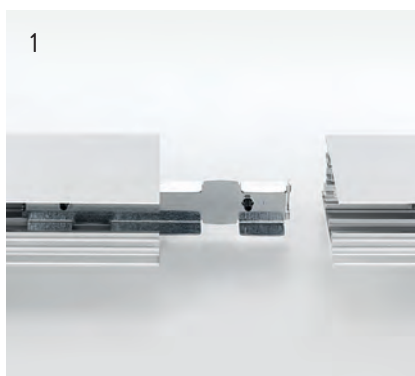

- 1 - Inserimento del giunto meccanico fra i moduli strutturali
Inserting mechanical joint between the rail modules
- 2 - Accoppiamento dei moduli strutturali
Matching of rail modules
- 3 - Fissaggio e allineamento dei moduli strutturali grazie alle apposite viti di regolazione
Fixing and alignment of the rail modules thanks to the appropriate adjustment screws

L'installazione di Karma è rapida, semplice ed intuitiva; una volta fissati a soffitto i moduli strutturali già precablati, si montano i moduli ottici con un semplice click grazie al sistema di fissaggio magnetico incorporato. Il collegamento elettrico dei moduli ottici è in bassissima tensione e avviene senza utensili grazie all'apposito "fast plug". Il sistema di regolazione della lunghezza del cavo di sospensione è facilmente accessibile perché collocato direttamente sul modulo strutturale.

The installation of Karma is quick, simple and intuitive; once the pre-wired rail modules are fixed to the wall, the optical modules are mounted with a simple click thanks to the built-in magnetic fixing system. The electrical connection of the optical modules is in very low voltage and without tools thanks to the special "fast plug". The suspension cable length adjustment system is easily accessible because it is placed directly on the rail module.



KARMA_Ceiling

Accessories
Wall

5

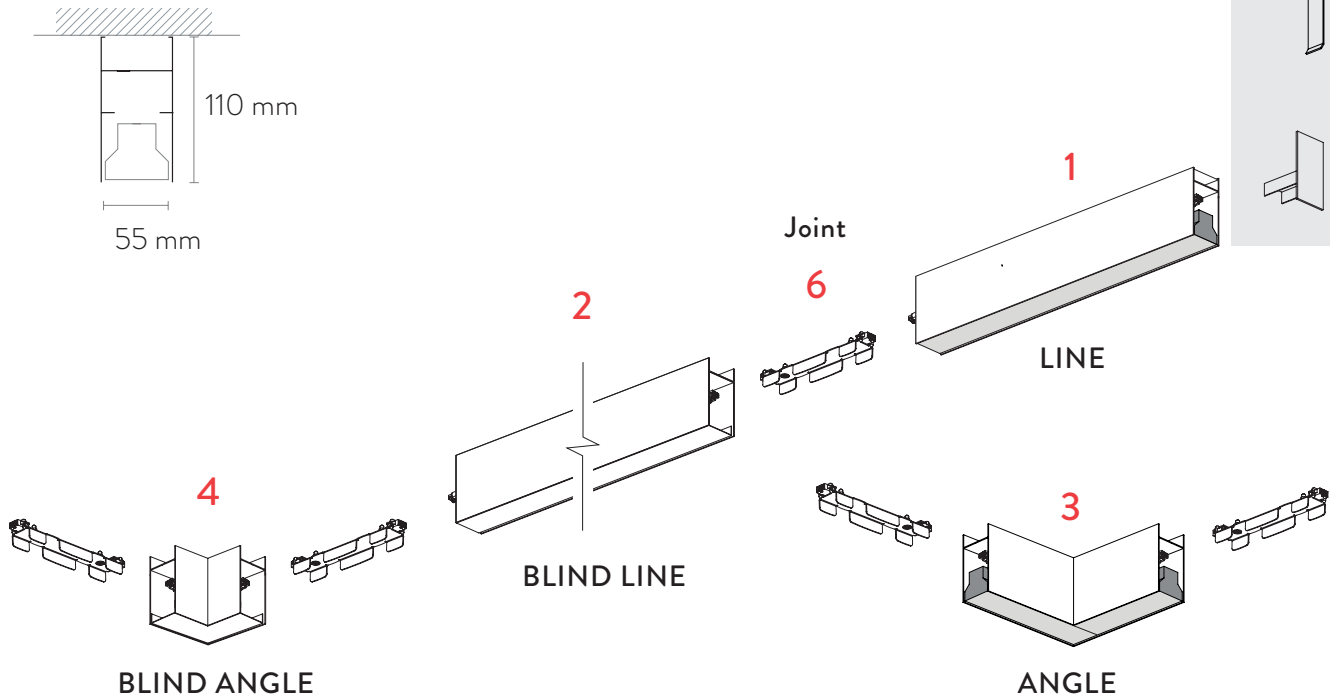

1 Line Downlight

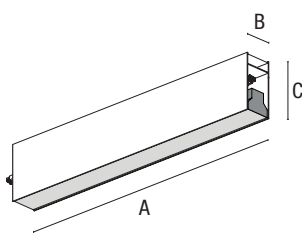

Model	Power	Lumen output	Product dimension			* code to complete
			A	B	C	
600	12 W	1879 lm	573 mm	55 mm	110 mm	SE-HAAAA ■ △ ● □
1100	24 W	3758 lm	1131 mm	55 mm	110 mm	SE-HAABC ■ △ ● □
1700	36 W	5637 lm	1691 mm	55 mm	110 mm	SE-HAACD ■ △ ● □
2200	48 W	7516 lm	2250 mm	55 mm	110 mm	SE-HAADE ■ △ ● □

⊕ 220÷240Vac | IP40

UP to 157 lm/W | UP to UGR≥19 | L80/B20 80.000 h. | CRI>90 | UP to RG0 | SDCM<3
Lumen output values: luminaire luminous flux at 4000 K - optics 60°

2 Blind Line

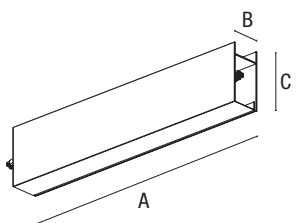

Model	Power	Lumen output	Product dimension			* code to complete
			A	B	C	
600	/	/	573 mm	55 mm	110 mm	SE-HAEA ●
1100	/	/	1131 mm	55 mm	110 mm	SE-HAEB ●
1700	/	/	1691 mm	55 mm	110 mm	SE-HAEC ●

3 Angle Downlight

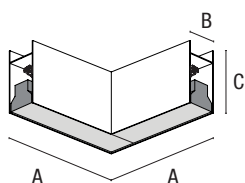

Model	Power	Lumen output	Product dimension			* code to complete
			A	B	C	
600x600	24 W	2705 lm	600 mm	55 mm	110 mm	SE-HFAMC ■ ▲ ● □
⊕ 220÷240Vac IP40		UP to 112 lm/W UP to UGR≥19 L80/B20 80.000 h. CRI>90 RG0 SDCM<3 Lumen output values: luminaire luminous flux at 4000 K - Only 120° optics				

4 Blind Angle

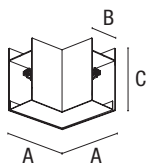

Model	Power	Lumen output	Product dimension			* code to complete
			A	B	C	
250x250	/	/	250 mm	55 mm	110 mm	SE-HFEZ ●

5 Accessories Wall

Description	* code to complete
Fixing bracket (2x)	ATS05202
End Cap (2x)	AT ● 07301

6 Joint

Description	code
Metal connection	ATS03303

Optical Info p. 528

* Select your option

CCT	Optic	Colour	Control	#
2700 K 1	60° B	White W	On/Off NF	Only: 120° - DALI (DT8), Casambi
3000 K 2	90° C	Black B	DALI DA	** Only: 1700 - 2200
4000 K 3	120° E	Corten C	Em. 1h ** H1	*** Configurations up to max 2800 mm length
Tunable # % 4	Asy F	Lunar Grey G	Casambi **** CA	% Only: 1100 - 1700 - 2200
	Sym G	Tobacco O	Push *** PU	

Finishes

White Black Corten Lunar Grey Tobacco



MAYA_Ceiling

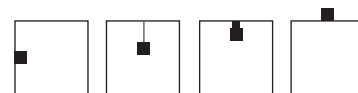

Il sistema Maya offre diverse tipologie d'installazione. La versione da soffitto rientra tra quelle più flessibili ed utilizzate. In versione stand alone oppure un sistema continuo, Maya soffitto esprime al meglio design curato, efficienza tecnologica ed estetica del progetto. Diverse le lunghezze del profilo che attraverso giunti ed angoli permette di disegnare la configurazione desiderata in piena libertà. Caratteristica primaria è il sistema di fissaggio a soffitto che attraverso molle speciali permette l'installazione in perfetta aderenza (gap zero). La gestione elettronica è affidata a componenti di primissimo livello in grado di garantire le migliori prestazioni per efficienza e stabilità nel tempo. È coperta l'intera gamma di alimentazione: On/Off, Dali, Push, Casambi. Maya impiega schede Led ad alta efficienza nelle varianti 2700K, 3000K e 4000K nonché una versione tunable white.

The Maya system offers various types of installations. The ceiling version is among the most flexible and widely used. Whether as a stand-alone or continuous system, Maya ceiling expresses the best in well-designed aesthetics, technological efficiency, and project aesthetics. There are different lengths of the profile that, through joints and angles, allow the freedom to create the desired configuration. The primary feature is the ceiling mounting system, which uses special springs to ensure a perfect fit (zero gap) during installation. The electronic management relies on top-quality components capable of guaranteeing the best performance in terms of efficiency and long-term stability. The entire range of power supply options is covered: On/Off, Dali, Push, Casambi. Maya utilizes high-efficiency LED boards in 2700K, 3000K, and 4000K variants, as well as a tunable white version.



+ MAYA Wall pag 332



+ MAYA Pendant pag 276



EXTENDED COLLECTION



+ MAYA Track pag 212

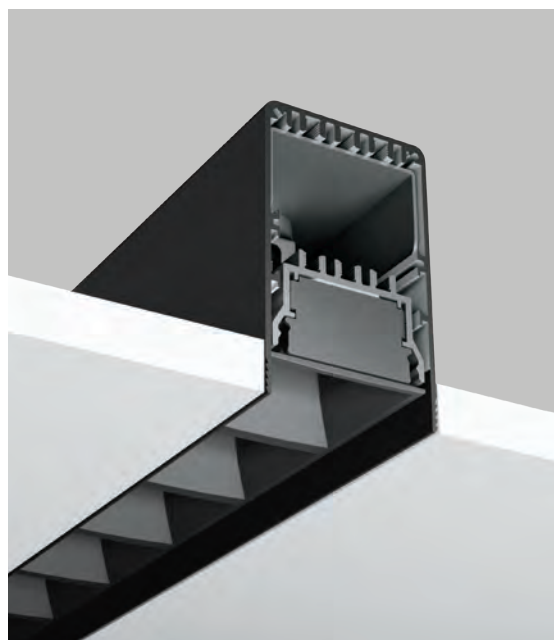

+ MAYA Recessed pag 062

MAYA_Ceiling

MODEL

300

600

1100

1700

2200

2800

Maya plafone si integra perfettamente in ogni ambiente. Minimalismo e flessibilità sono i suoi punti di forza. Disponibile in diverse misure e colori è facilmente configurabile usando lo strumento dedicato.

Maya ceiling integrates perfectly into any environment. Minimalism and flexibility are its strengths. Available in different sizes and colours, it is easily configured using the dedicated tool.

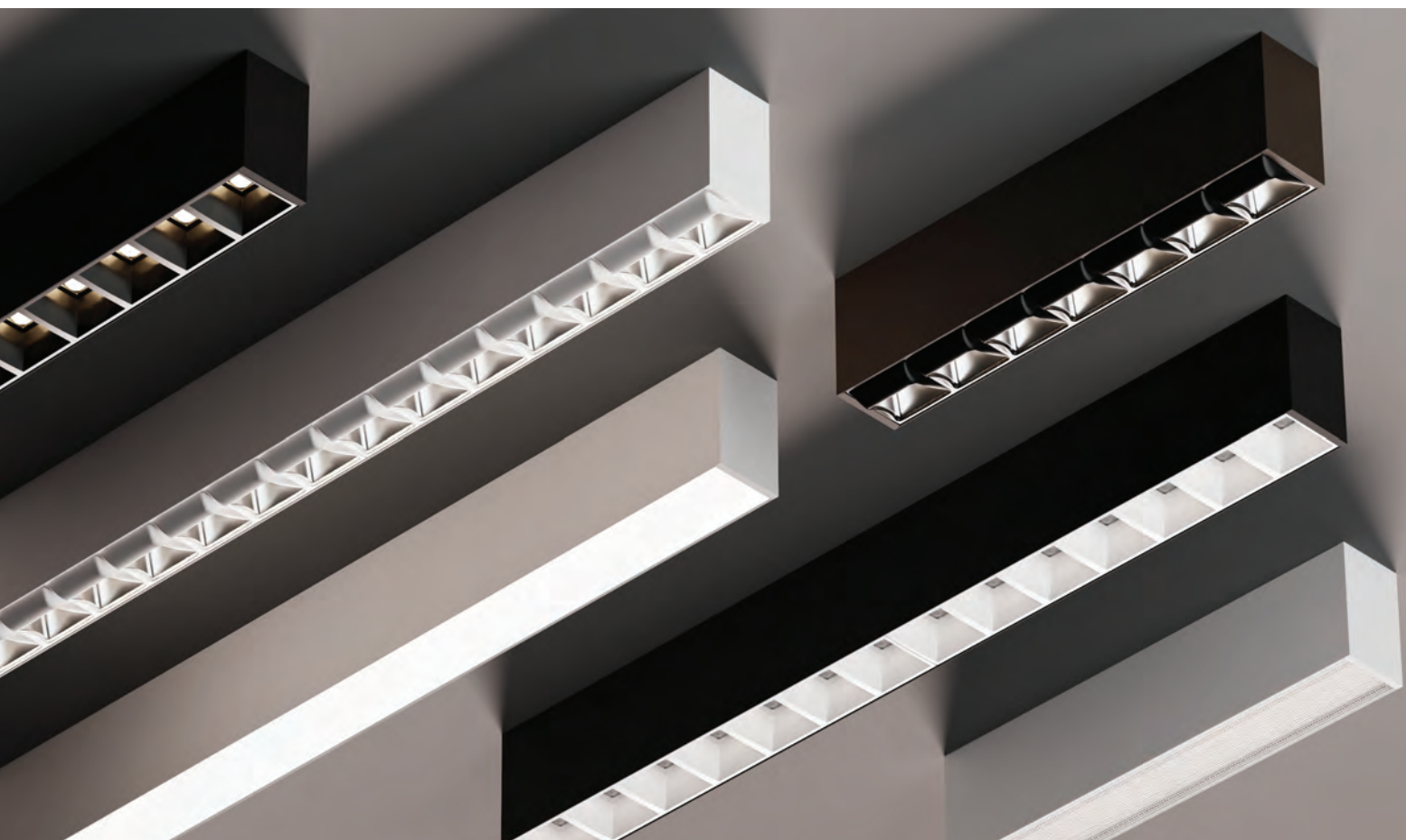



120°

Le misure 30 e 60 si coniugano perfettamente con lo schermo opale. Le basse potenze impegnate esaltano il rendimento garantendo una buona emissione diffusa. Questa soluzione è ideale per l'illuminazione generale di piccoli spazi senza rinunciare ad un buon valore estetico.

Sizes 30 and 60 combine perfectly with the opal screen. The low wattages enhance performance while ensuring good diffuse emission. This solution is ideal for general lighting of small spaces without sacrificing good aesthetic value.



MICROPRISMATIC

La gamma consente l'utilizzo di schermo microprismatico. Questa soluzione, con UGR <19 si qualifica per l'impiego in ambienti specifici ed in situazioni dove viene richiesta una riduzione dell'abbagliamento.

The range allows the use of microprismatic screens. This solution, with UGR <19, is suitable for use in specific environments and in situations where glare reduction is required.



50°/80°

In questa configurazione vengono evidenziate le caratteristiche di Maya plafone. L'apparecchio può dotarsi di schede adattive che consentono l'impiego di ottiche ad alta efficienza con forte riduzione dell'abbagliamento. Due le tipologie di lenti associabile ai riflettori: 50° ed 80°. La soluzione è ideale in ogni applicazione ove si debba limitare l'irraggiamento dei flussi nell'ambiente.

In this configuration, the features of the Maya ceiling-mounted luminaire are highlighted. The luminaire can be fitted with adaptive boards that allow the use of high-efficiency optics with strong glare reduction. Two types of lenses can be combined with the reflectors: 50° and 80°. The solution is ideal in any application where glare must be limited in the environment.



ASYMMETRIC

Un ulteriore elemento si può configurare su Maya plafone. Un riflettore asimmetrico si monta sull'apparecchio mantenendo invariate misure e flussi luminosi. Con questa funzionalità il prodotto assolve perfettamente ad illuminazioni specifiche e dedicate verso pareti ed oggetti limitando l'abbagliamento.

An additional element can be configured on the Maya ceiling luminaire. An asymmetrical reflector is mounted on the luminaire while maintaining the same dimensions and luminous flux. With this feature, the product perfectly fulfils specific and dedicated illuminations towards walls and objects while limiting glare.

MAYA_Ceiling

OVERVIEW

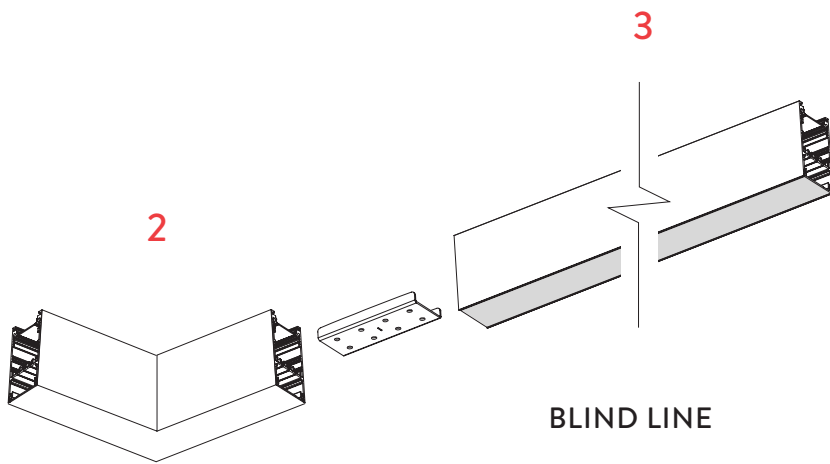
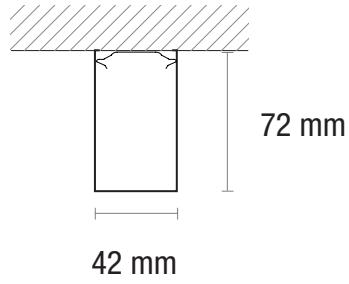

5

Joint

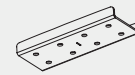

Metal connection

1

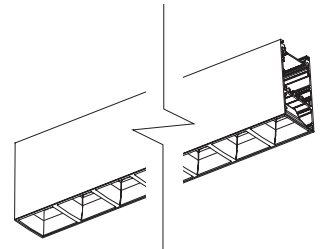

LINE

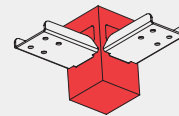

L

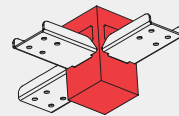

T



120°

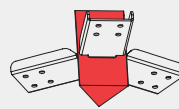
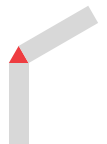

Y

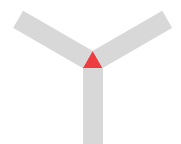

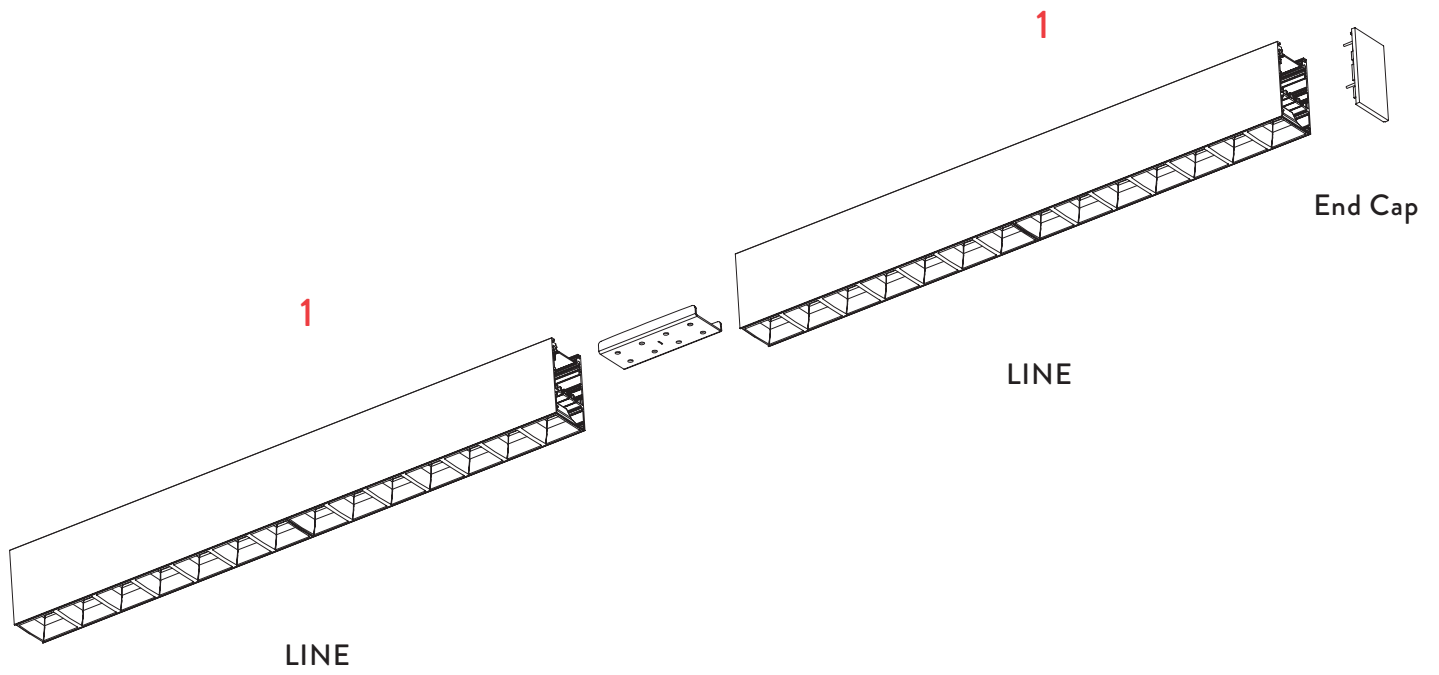

ACCESSORIES

4



Fixing Clip



End Cap



The version
is available
for desktop

1 Line

Downlight	Length	Power	Lumen	* code to complete
	300* (Stand Alone only)	6 W	760 lm	SM-HAAVQ ■ △ ● □
	600	12 W	1518 lm	SM-HAAAA ■ △ ● □
	1100	24 W	3036 lm	SM-HAABC ■ △ ● □
	1700	36 W	4554 lm	SM-HAACD ■ △ ● □
	2200	48 W	6072 lm	SM-HAADE ■ △ ● □
	2800	60 W	7950 lm	SM-HAAWF ■ △ ● □

⊕ 220÷240Vac | IP40

UP to 127 lm/W | UP to UGR≥16 | L80/B20 80.000 h. | CRI>90 | UP to RG0 | SDCM<3
Lumen output values: luminaire luminous flux at 4000 K - optics 50°

2 Angle

Downlight	Length	Power	Lumen	* code to complete
	600x600	24 W	3036 lm	SM-HFAMC ■ △ ● □

⊕ 220÷240Vac | IP40

UP to 105 lm/W | UGR≥19 | L80/B20 80.000 h. | CRI>90 | UP to RG0 | SDCM<3
Lumen output values: luminaire luminous flux at 4000 K - optics 50°

3 Blind Line

Length	* code to complete
300	SM-HAEV ●
600	SM-HAEA ●
1100	SM-HAEB ●
1700	SM-HAEC ●
2200	SM-HAED ●

Optical Info p. 528

* Select your option

CCT	Optic	Colour	Control	#
2700 K 1	120° E	White W	On/Off NF	Only: 120° - DALI(DT8), Casambi
3000 K 2	Micro M	Black B	DALI DA	** Only: 1700 - 2200 - 2800
4000 K 3	50° White N	Corten C	Em. 1h ** H1	*** Configurations up to max 2800 mm length
Tunable # 4	50° Black O	Lunar Grey G	Casambi CA	
	80° White P	Tobacco O	Push *** PU	
	80° Black Q	Beech Wood H		
	Asy White R	Oak Wood I		
	Asy Black S	Walnut Wood L		
		Antique Marble S		

4 Accessories

Description	* code to complete
Fixing Clip (2x line 300, 600, 1100 - 3x line 1700, 2200, 2800 - 4x angle)	CSS05202
End Cap (2x)	CS ▼ 07301

5 Joint

L	CS ▼ 03312
T	CS ▼ 03313
120°	CS ▼ 03310
Y	CS ▼ 03311
Metal connection	CSS03304

* Select your option

Accessories + Joint colour ▼

White	W
Black	B
Corten	C
Grey	G
Tobacco	O
Sand	V
Sage Green	U

MAYA_mini Ceiling



Maya_Mini nelle versioni installabili a Parete - Soffitto esalta le ridotte dimensioni del profilo e ne aumenta attrattiva e funzionalità. Questa soluzione offre una vasta scelta su tipologia, dimensioni ed orientabilità mantenendo l'esclusività su finiture e prestazioni. Due i modelli di base : installazione fissa oppure con flusso luminoso orientabile. Le dimensioni variano dai 300 mm del modello più piccolo si arriva ai 2200 mm della versione più grande. Tante le tipologie funzionali: colori della scheda led, ottiche, dimmerazioni. A queste infinite variabili si aggiunge la scelta della gamma colori. Oltre i classici bianco e nero si spazia in combinazioni accattivanti facilmente selezionabili con il configuratore dedicato.

Maya_Mini, in its wall and ceiling installable versions, enhances the compact size of the profile and increases its attractiveness and functionality. This solution offers a wide range of options in terms of type, dimensions, and adjustability while maintaining exclusivity in finishes and performance. There are two basic models: fixed installation or adjustable light flow. The sizes range from 300 mm for the smallest model to 2200 mm for the largest version. There are various functional options available, such as LED board colors, optics, and dimming capabilities. In addition to these infinite variables, there is also a choice of color range. Beyond the classic white and black, there are captivating combinations easily selectable with the dedicated configurator.



+ MAYA_mini Floor pag 402



+ MAYA_mini Pendant pag 284



+ MAYA_mini Wall pag 340

EXTENDED
COLLECTION



MAYA_mini Ceiling

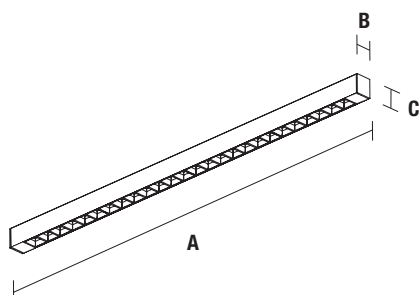

Model	Power	Lumen output	Product dimension			* code to complete
			A	B	C	
1100	24 W	3036 lm	1220 mm	42 mm	50 mm	MM-CABC ■ △ □ ● ▼
1700	36 W	4554 lm	1720 mm	42 mm	50 mm	MM-CACD ■ △ □ ● ▼
2200	48 W	6072 lm	2340 mm	42 mm	50 mm	MM-CADE ■ △ □ ● ▼

⊕ 220÷240Vac | IP40

UP to 127 lm/W | UP to UGR≥16 | L80/B20 80.000 h. | CRI>90 | UP to RG0 | SDCM<3
Lumen output values: luminaire luminous flux at 4000 K - optics 50°

Optical Info p. 528

* Select your option

CCT	■	Optic	△	Control	□	Structure colour	●	End Cap colour	▼
2700 K	1	120°	E	On/Off	NF	White	WW	White	W
3000 K	2	Micro	M	DALI	DA	Black	BB	Black	B
4000 K	3	50° White	N	Casambi	CA	Lunar Grey	GG	Sand	V
		50° Black	O	Push	PU	Tobacco	OO	Tobacco	O
		80° White	P			Old Zebra	MM	Gray	G
		80° Black	Q			Green Grass	NN	Sage Green	U
						Oman Red	PP	Orange Fluo	A
						Desert Camouflage	QQ		
						Beech Wood	HH		
						Oak Wood	II		
						Walnut Wood	LL		
						Antique Marble	SS		
						Concrete	TT		

MAYA_mini ADJ

L'allargamento della gamma Maya_Mini propone soluzioni all'avanguardia nella tecnologia e nell'estetica. Maya_Mini_Adj si candida ad occupare un posto di rilievo nella sezione della luce proiettata. Le ottiche in uso sul sistema vengono proposte con schede Led di diversa dimensione: 300/600/900 mm. Flussi luminosi importanti, con ottiche a scelta tra 50° ed 80°, possono essere installate a soffitto, a parete, a terra. Orientabilità del flusso luminoso di 120° a destra e sinistra sull'asse.

The expansion of Maya_Mini range offers cutting-edge solutions in aesthetics and technology. Maya_Mini_Adj is a candidate for a prominent place in our projected light section. The optics used on the system are offered with Led boards of different sizes: 300/600/900 mm. Important luminous fluxes, with optics between 50° and 80°, can be installed on the ceiling, wall, ground. Lumen flux can be adjusted 120° on right and left of central axis.

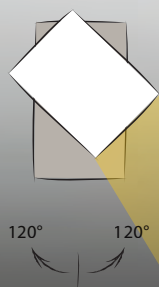

MAYA_mini Adj

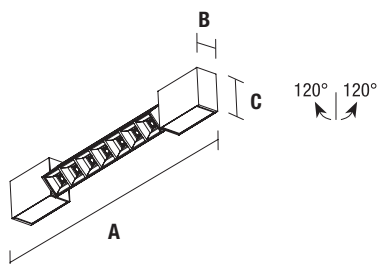

Model	Power	Lumen output	Product dimension			* code to complete
			A	B	C	
300	8 W	990 lm	489 mm	42 mm	72 mm	MM-OAVQ ■ ▲ □ ● ☼ ▼
600	16 W	1975 lm	769 mm	42 mm	72 mm	MM-OAAA ■ ▲ □ ● ☼ ▼
900	24 W	2965 lm	1066 mm	42 mm	72 mm	MM-OAUR ■ ▲ □ ● ☼ ▼

⚡ 220÷240Vac | IP40

UP to 123 lm/W | L80/B20 80.000 h. | CRI>90 | UP to RG0 | SDCM<3
Lumen output values: luminaire luminous flux at 4000 K - optics 50°

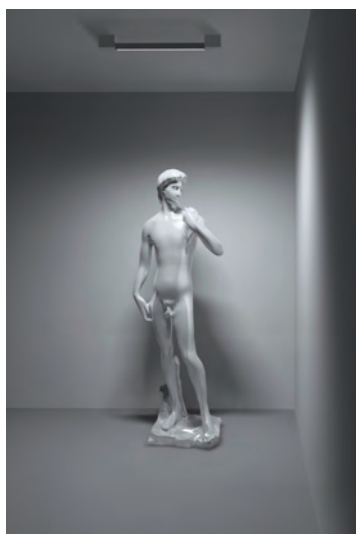

Optical Info p. 528

* Select your option

CCT	■	Optic	▲	Control	□	Colour central module	●	Colour side modules	☼	End Cap colour	▼
2700 K	1	120°	E	On/Off	NF	White	W	White	WW	White	W
3000 K	2	Micro	M	DALI	DA	Black	B	Black	BB	Black	B
4000 K	3	50° White	N	Push	PU	Lunar Grey	G	Lunar Grey	GG	Grey	G
		50° Black	O			Tobacco	O	Tobacco	OO	Tobacco	O
		80° White	P			Old Zebra	M	Beech Wood	HH	Sand	V
		80° Black	Q			Green Grass	N	Oak Wood	II	Sage Green	U
						Oman Red	P	Walnut Wood	LL		
						Desert Camouflage	Q	Antique Marble	SS		
						Beech Wood	H				
						Oak Wood	I				
						Walnut Wood	L				
						Antique Marble	S				
						Concrete	T				

EXTREME_Ceiling/Wall

Il proiettore Extreme è disponibile anche con installazione soffitto. La base cilindrica, naturale estensione del design dell'apparecchio, ospita la sezione alimentazione. Rimane pienamente disponibile l'orientamento sull'asse verticale ed orizzontale. L'apparecchio dispone di schede led con tono colore 2700K, 3000K e 4000K. I colori dell'anello in alluminio tornito, ottenuti con trattamento speciale, qualificano marcatamente gli ambienti in cui vengono installati.

The Extreme projector is also available for ceiling installation. The cylindrical base, a natural extension of the device's design, houses the power supply section. Full orientation is maintained along the vertical and horizontal axes. The device is equipped with LED boards with color tones of 2700K, 3000K, and 4000K. The colors of the aluminum ring, obtained through a special treatment, distinctly enhance the environments in which they are installed.

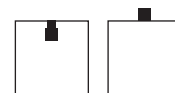

✦ EXTREME Recessed pag 076

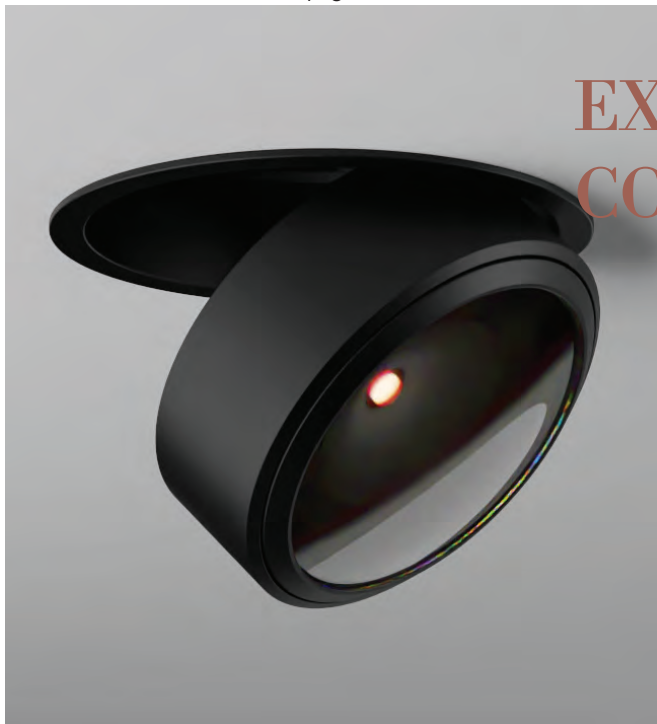

EXTENDED COLLECTION



✦ EXTREME Track pag 208



EXTREME_Ceiling/Wall

12 W

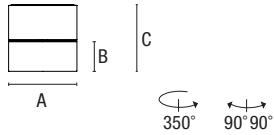

Control	Lumen output	Product dimension			Weight	*code to complete
		A	B	C		
On Off	1447 lm	103 mm	45 mm	97 mm	0,71 kg	TF-BA NF
⊕ 220÷240Vac IP20		CoB LED CRI>90 RG1 SDCM<3 UP to 104 lm/W L80/B20 80.000 h. Lumen output values: luminaire luminous flux at 4000 K - optics 38°				

18 W



Control	Lumen output	Product dimension			Weight	*code to complete
		A	B	C		
On Off	1852 lm	103 mm	45 mm	97 mm	0,71 kg	TF-BB NF
⊕ 220÷240Vac IP20		CoB LED CRI>90 RG1 SDCM<3 UP to 103 lm/W L80/B20 80.000 h. Lumen output values: luminaire luminous flux at 4000 K - optics 38°				

Optical Info p. 534

* Select your option

Colour Body		CCT		Optic		Colour Ring	
White	W	2700 K	1	15°	1	White	W
Black	B	3000 K	2	24°	2	Black	B
		4000 K	3	38°	3	Rose Gold	S
				55°	4	Bronze	Z
						Titanium	T
						Satin steel	A



EXTREME_Ceiling/Wall

12 W

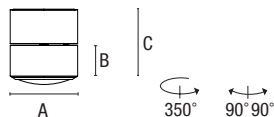

Control	Lumen output	Product dimension			Weight	*code to complete
		A	B	C		
On Off	1228 lm	103 mm	60 mm	112 mm	0,84 kg	TF-BA NF
⊕ 220÷240Vac IP20						
CoB LED CRI>90 RG1 SDCM<3 UP to 88 lm/W L70/B10 60.000 h. Lumen output values: luminaire luminous flux at 4000 K						

18 W

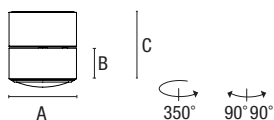

Control	Lumen output	Product dimension			Weight	*code to complete
		A	B	C		
On Off	1426 lm	103 mm	60 mm	112 mm	0,84 kg	TF-BB NF
⊕ 220÷240Vac IP20						
CoB LED CRI>90 RG1 SDCM<3 UP to 80 lm/W L70/B10 60.000 h. Lumen output values: luminaire luminous flux at 4000 K						

Optical Info p. 534

* Select your option

Colour Body		CCT		Optic		Colour Ring	
White	W	2700 K	1	120°	5	White	W
Black	B	3000 K	2			Black	B
		4000 K	3			Rose Gold	S
						Bronze	Z
						Titanium	T
						Satin steel	A

SKA_Ceiling/Wall



I proiettori della serie SKA sono particolarmente indicati per l'illuminazione degli ambienti commerciali come i negozi e gli store. Le elevate prestazioni consentono di illuminare adeguatamente le superfici espositive e gli ambienti ove si richiede affidabilità e qualità della luce. I proiettori della serie Ska montano componenti selezionati (prime brand) e LED con elevate qualità cromatiche (CRI > 90 e SDCM < 3). Il flusso luminoso è ottimizzato da riflettori con alto rendimento a garanzia della massima efficienza e flessibilità dell'impianto. La versione "BASE", facilmente installabile a parete o soffitto, si può integrare con staffe opportunamente progettate che ne ampliano il range di utilizzo. La staffa è disponibile nelle versioni 1/2/4 apparecchi. Utilissima per creare cluster di proiettori dalla notevole potenza luminosa.

SKA series projectors are particularly suitable for commercial lighting such as shops and stores. The high performance allows to adequately illuminate the exhibition surfaces and environments where reliability and quality of light are required. The projectors of the Ska series have selected components (prime brands) and LEDs with high color qualities (CRI > 90 and SDCM < 3). The luminous flux is optimized by reflectors with high efficiency to ensure maximum efficiency and flexibility of the system. The "BASE" version, easy to install on wall or ceiling, can be integrated with appropriate brackets that expand the range of use. The bracket is available in 1/2/4 units. Useful to create clusters of projectors with considerable light output.





EXTENDED
COLLECTION

SKA_Ceiling/Wall

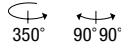
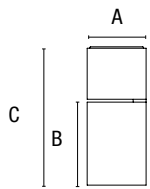

Power	Control	Lumen output	Product dimension			Weight	*code to complete
			A	B	C		
25 W	On/Off	2620 lm	82 mm	118 mm	192 mm	0,80 kg	TD-BD ● □ NF ▼
33 W	On/Off	3460 lm	95 mm	136 mm	207 mm	1,20 kg	TD-BE ● □ NF ▼





⊕ 220÷240Vac | IP20

CRI>90 | RG1 | SDCM<3

UP to 105 lm/W | L80/B20 50.000 h.

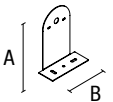
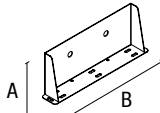
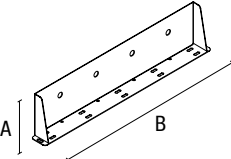
Lumen output values: luminaire luminous flux at 4000 K - optics 36°

Accessories

Description	Weight	Product dimension		Colour	25W	33W
		A	B			
Bracket "Elle"						
	0,40 kg	210 mm	160 mm	White	TRK70502	
				Black	TRK70503	
	1,5 kg	210 mm	420 mm	White	TRK70504	
				Black	TRK70505	
	3 kg	210 mm	740 mm	White	TRK70506	
				Black	TRK70507	
	Honeycomb grid	0,02 kg			TRK60358	TRK60363
	Barn doors	0,03 kg			TRK60359	TRK60364
	Ex snot	0,08 Kg		White	TRK60357	/
				Black	TRK50357	/

Optical Info p. 533

* Select your option

CCT	●	Optic	□	Colour Ring	▼
3000 K	2	15°	1	White	W
4000 K	3	36°	3	Black	B
		55°	4		

Bracket "Elle"



SLIM_Ceiling/Wall



Slim in versione parete – soffitto è parte integrante della collezione assieme alla versione track e semi-incasso. Il driver è posizionato all'interno dell'apparecchio così da privilegiare forme contenute nel dimensionamento della base. Diverse le scelte all'interno della gamma: potenze di 12W, 20W, 33W; schede led con tono colore 2700K, 3000K e 4000K; ottiche con diverse angolazioni unitamente ad una palette colori allargata ampliano i valori della proposta e le possibilità d'installazione.

The Slim wall-ceiling version is an integral part of the collection, along with the track and semi-recessed versions. The driver is positioned inside the fixture, allowing for compact forms within the base dimensions. There are several choices within the range: power options of 12W, 20W, 33W; LED boards with color tones of 2700K, 3000K, and 4000K; optics with various angles, along with an expanded color palette, broaden the range of offerings and installation possibilities.



+ SLIM Track pag 192



+ SLIM GU10 Track pag 198



+ SLIM Semirecessed pag 072

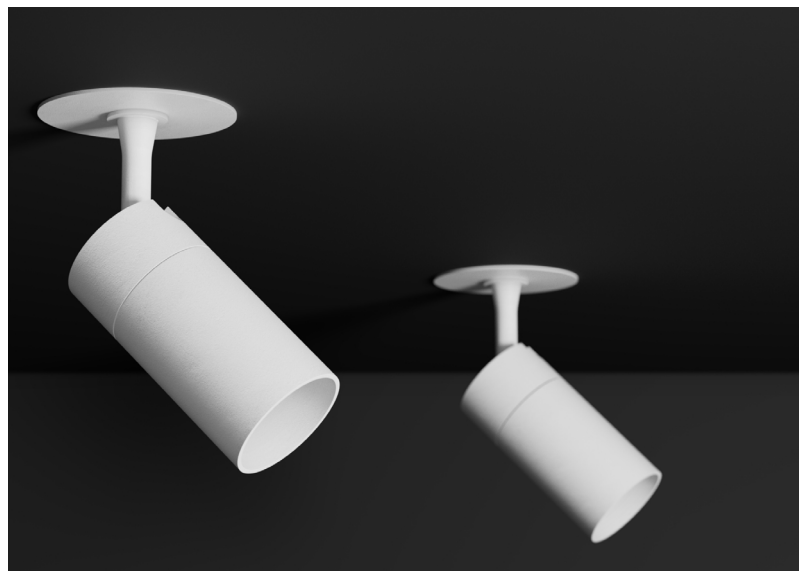

+ SLIM GU10 Semirecessed pag 072

EXTENDED COLLECTION

SLIM_Ceiling/Wall

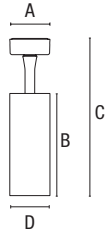

Power	Control	Lumen output	Hole size	Product dimension				Weight	* code to complete
				A	B	C	D		
12W	On/Off	1255 lm	/	52 mm	134 mm	203 mm	52 mm	0,40 kg	TB-BA + ● □ NF ▼
20W	On/Off	2280 lm	/	75 mm	170 mm	234 mm	55 mm	0,57 kg	TB-BC + ● □ NF ▼
33W	On/Off	3486 lm	/	75 mm	165 mm	239 mm	72 mm	0,77 kg	TB-BE + ● □ NF ▼

⊕ 220÷240Vac | IP20

CRI>90 | RG1 | SDCM<3
UP to 114 lm/W | L80/B20 50.000 h.

Lumen output values: luminaire luminous flux at 4000 K - optics 38°

* Select your option

Colour Base	+	CCT	●	Optic	□	Colour	▼
White	W	2700 K	1	15°	1	White	W
Black	B	3000 K	2	24°	2	Black	B
		4000 K	3	38°	4		
				55°	5		

SLIM_GU10 Ceiling/Wall

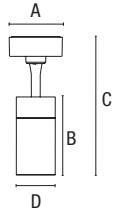

Power	Source	Lumen output	Product dimension				Weight	* code to complete
			A	B	C	D		
1x max 50 W	GU10	/	75 mm	110 mm	194 mm	55 mm	0,33 kg	TC-B ▼
<input type="checkbox"/> 220÷240Vac IP20								Lamp not included

* Select your option

Colour ▼

White W
Black B

HOOP



p.290

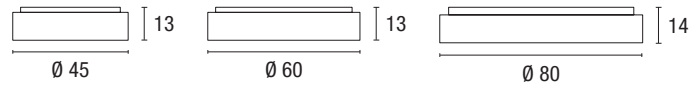

Hoop è una plafoniera realizzata in alluminio verniciato bianco opaco ed equipaggiata di schermo diffondente in PMMA. Permette di ottenere una luce morbida e diffusa per illuminare gli ambienti in modo confortevole e senza la presenza di ombre dure. Il driver è incluso nell'apparecchio, può essere On/Off o dimmerabile multifunzione con controllo 1...10V, Push, DALI, ed alimenta le sorgenti LED SMD ad alta efficienza. Hoop è disponibile nella versione a plafone in diverse misure e potenze, e si completa con le analoghe versioni a sospensione.

Hoop is aluminium ceiling luminaire matt white painted, equipped with a diffusing screen in PMMA. It allows to obtain a soft and diffused light to illuminate indoor ambients comfortably and without harsh shadows. The driver is included in the fixture, it can be On/Off or dimmable multifunction 1...10 V, Push, DALI controlled, and feeds a highly efficient SMD LED source. Hoop is available in the ceiling version in different sizes and light emissions and is completed with the same suspension versions.

Optical Info p. 534

Model	Colour	Ø	Power	Source	Lumen Output	CCT	Weight	Code
On/Off	White	45 mm	32 W	SMD LED	1920 lm	3000 K	1,7 kg	PLA00134
		60 mm	42 W	SMD LED	2520 lm	3000 K	2,5 kg	PLA00137
		80 mm	62 W	SMD LED	3720 lm	3000 K	4,7 kg	PLA00139
Dimmerabile DALI / 1...10 V / Push	White	45 mm	32 W	SMD LED	1920 lm	3000 K	1,7 kg	PLA00134DA
		60 mm	42 W	SMD LED	2520 lm	3000 K	2,5 kg	PLA00137DA
		80 mm	62 W	SMD LED	3720 lm	3000 K	4,7 kg	PLA00139DA

 220-240Vac | IP20

Versioni dimmerabili: regolazione della luminosità 0/1 - 100 % - Dimmable versions: light regulation 0/1 - 100 %

Finishes

White



CORONA



p.292

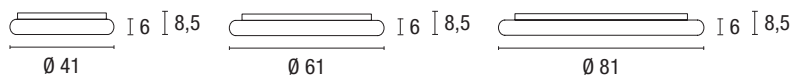

Corona è realizzata in alluminio verniciato bianco opaco ed è dotata di schermo diffondente in PMMA che permette di ottenere effetti di luce morbida e diffusa. La curvatura del corpo in alluminio si abbina perfettamente alla curvatura dello schermo interno in PMMA per realizzare un'unica forma dal design morbido e contemporaneo. La sorgente SMD LED ad alta efficienza è alimentata dal driver integrato nell'apparecchio e può essere On/Off o dimmerabile multifunzione con controllo 1...10V, Push, DALI. Corona è disponibile in diverse misure e potenze e si abbina alle versioni a sospensione.

Corona is made of matt white painted aluminium and is equipped with a PMMA diffusing screen which allows to obtain soft and diffused light effects. The curvature of the aluminium body perfectly matches the curvature of the internal PMMA screen to create a single shape with a soft and contemporary design. The high efficiency SMD LED source is powered by the driver integrated in the fixture and can be On/Off or dimmable multifunction 1...10 V, Push, DALI controlled. Corona is available in different sizes and powers and goes well with the suspension versions.

Optical Info p. 534

Model	Colour	Ø	Power	Source	Lumen Output	CCT	Weight	Code
On/Off	White	41 mm	32 W	SMD LED	1920 lm	3000 K	2,2 kg	GRF02111
		61 mm	50 W	SMD LED	3000 lm	3000 K	4,2 kg	GRF02211
		81 mm	80 W	SMD LED	4800 lm	3000 K	6,4 kg	GRF02311
Dimmerabile DALI / 1...10 V / Push	White	41 mm	32 W	SMD LED	1920 lm	3000 K	2,2 kg	GRF02111DM
		61 mm	50 W	SMD LED	3000 lm	3000 K	4,2 kg	GRF02211DM
		81 mm	80 W	SMD LED	4800 lm	3000 K	6,4 kg	GRF02311DM

220÷240Vac | IP20

Versioni dimmerabili: regolazione della luminosità 0/1 - 100 % - Dimmable versions: light regulation 0/1 - 100 %

Finishes

White



PENNY



Penny è realizzata in alluminio verniciato bianco opaco e si caratterizza per il suo grande schermo inferiore in PMMA che si illumina in modo perfettamente uniforme; utilizzando Penny si ottengono effetti di luce morbida e diffusa verso il basso con emissioni fino a 12700 lumen nella versione di maggior diametro; Penny è quindi particolarmente indicata per illuminare grandi ambienti con luce uniforme, perfettamente distribuita e senza ombre dure. Equipaggiata con sorgenti SMD LED ad alta efficienza, Penny è completa di driver integrati nel corpo dell'apparecchio ed è disponibile con controllo On/Off o dimmerabile multifunzione 1...10V, Push, DALI. Penny è disponibile in diverse misure e potenze e si abbina alle corrispondenti versioni a sospensione.

Penny is aluminium ceiling mounted luminaire in matt white painted color; it is characterized by its large PMMA lower screen which lights up perfectly evenly; by using Penny soft and diffused down light effects are obtained with emissions up to 12700 lumens in the larger diameter version; Penny is therefore particularly suitable for illuminating large rooms with uniform and perfectly distributed light without harsh shadows. Equipped with high efficiency SMD LED sources, Penny is complete with drivers integrated in the body of the fixture and is available with On/Off control or dimmable multifunction 1...10 V, Push, DALI. Penny is available in different sizes and powers and can be combined with the corresponding suspension versions.

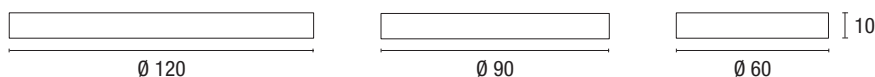

Model	Colour	Ø	Power	Source	Lumen Output	CCT	Weight	Code
On/Off	White	60 mm	60 W	SMD LED	3900 lm	3000 K	3,8 kg	GRF05111
		90 mm	120 W	SMD LED	7800 lm	3000 K	11,5 kg	GRF05211
		120 mm	195 W	SMD LED	12675 lm	3000 K	16,8 kg	GRF05311
Dimmerabile DALI / 1...10 V / Push	White	60 mm	32 W	SMD LED	3900 lm	3000 K	3,8 kg	GRF05111DM
		90 mm	42 W	SMD LED	7800 lm	3000 K	11,5 kg	GRF05211DM
		120 mm	62 W	SMD LED	12675 lm	3000 K	16,8 kg	GRF05311DM

□ 220÷240 Vac | IP20

Versioni dimmerabili: regolazione della luminosità 0/1 - 100 % - Dimmable versions: light regulation 0/1 - 100 %

Finishes

White



KART



p.298

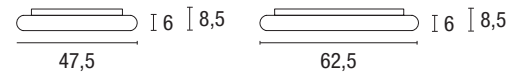

Kart è realizzata in alluminio verniciato bianco opaco ed è dotata di schermo diffondente in PMMA che permette di ottenere effetti di luce morbida e diffusa. La curvatura del corpo in alluminio si abbina perfettamente alla curvatura dello schermo interno in PMMA per realizzare un'unica forma dal design morbido e contemporaneo. La sorgente SMD LED ad alta efficienza è alimentata dal driver integrato nell'apparecchio e può essere On/Off o dimmerabile multifunzione con controllo 1...10V, Push, DALI. Kart è disponibile in diverse misure e potenze e si abbina alle versioni a sospensione.

Kart is made of matt white painted aluminium and is equipped with a PMMA diffusing screen which allows to obtain soft and diffused light effects. The curvature of the aluminium body perfectly matches the curvature of the internal PMMA screen to create a single shape with a soft and contemporary design. The high efficiency SMD LED source is powered by the driver integrated in the fixture and can be On/Off or dimmable multifunction 1...10 V, Push, DALI controlled. Kart is available in different sizes and powers and goes well with the suspension versions.

Optical Info p. 535

Model	Colour	Dimension	Power	Source	Lumen Output	CCT	Weight	Code
On/Off	White	47,5 x 47,5 mm	38 W	SMD LED	2290 lm	3000 K	3,3 kg	GRF03111
		62,5 x 62,5 mm	50 W	SMD LED	2450 lm	3000 K	5,0 kg	GRF03211
Dimmerabile DALI / 1...10 V / Push	White	47,5 x 47,5 mm	38 W	SMD LED	2290 lm	3000 K	3,3 kg	GRF03111DM
		62,5 x 62,5 mm	50 W	SMD LED	2450 lm	3000 K	5,0 kg	GRF03211DM

 220÷240Vac | IP20

Versioni dimmerabili: regolazione della luminosità 0/1 - 100 % - Dimmable versions: light regulation 0/1 - 100 %

Finishes

White

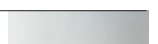

BIKE



p.294

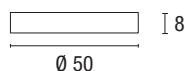

Ø 50

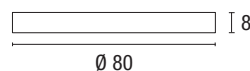

Ø 80

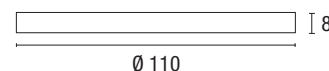

Ø 110

Bike è realizzata in alluminio verniciato bianco opaco ed è completa di schermo inferiore in PMMA; permette di realizzare effetti di luce morbida e diffusa verso il basso ed è particolarmente indicata per l'illuminazione generale di ambienti di medie o grandi dimensioni. La sua forma ad anello permette di vedere il soffitto nella parte interna dell'apparecchio. La sorgente SMD LED ad alta efficienza è alimentata dal driver integrato nell'apparecchio che può essere On/Off o dimmerabile multifunzione con controllo 1...10V, Push, DALI. Bike è disponibile in diverse misure e potenze e si abbina alle corrispondenti versioni a sospensione.

Bike is made of matt white painted aluminium and is complete with lower PMMA screen; it allows to create soft and diffused down light effects and is particularly suitable for general lighting of medium or large environments. Its ring shape allows you to see the ceiling on the inside of the appliance. The high efficiency SMD LED source is powered by the driver integrated in the fixture which can be On/Off or dimmable multifunction 1...10 V, Push, DALI controlled. Bike is available in different sizes and powers and can be combined with the corresponding suspension versions.

Optical Info p. 535

Model	Colour	Ø	Power	Source	Lumen Output	CCT	Weight	Code
On/Off	White	50 mm	38 W	SMD LED	2280 lm	3000 K	2,9 kg	GRF04111
		80 mm	80 W	SMD LED	4800 lm	3000 K	5,7 kg	GRF04211
		110 mm	120 W	SMD LED	7200 lm	3000 K	10,7 kg	GRF04311
Dimmerabile DALI / 1...10 V / Push	White	50 mm	38 W	SMD LED	2280 lm	3000 K	2,9 kg	GRF04111DM
		80 mm	80 W	SMD LED	4800 lm	3000 K	5,7 kg	GRF04211DM
		110 mm	120 W	SMD LED	7200 lm	3000 K	10,7 kg	GRF04311DM

 220-240Vac | IP20

Versioni dimmerabili: regolazione della luminosità 0/1 - 100 % - Dimmable versions: light regulation 0/1 - 100 %

Finishes

White



YOUNG

Young è realizzata in alluminio verniciato bianco opaco e si caratterizza per il ridotto spessore del corpo che la rende gradevole anche quando installata in ambienti con soffitti molto bassi; è dotata di schermo opalino diffondente in PMMA e, grazie alle sorgenti SMD LED integrate nel corpo dell'apparecchio, si illumina in modo perfettamente uniforme; Young permette di ottenere effetti di luce morbida e diffusa verso il basso, perfettamente distribuita e priva di ombre dure. Young è completa di driver integrati nel corpo dell'apparecchio.

Young is made of matt white painted aluminium and is characterized by the reduced thickness of the body which makes it pleasant even when installed in rooms with very low ceilings; it is equipped with an opal diffusing screen in PMMA and, thanks to the SMD LED sources integrated in the body of the luminaire, it lights up perfectly evenly; Young allows to obtain soft and diffused down light effects perfectly distributed and free of hard shadows. Young is complete with drivers integrated into the body of the device.



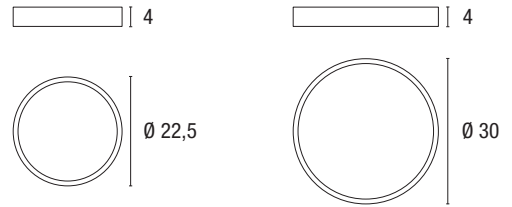

Optical Info p. 535

Colours	Ø	Power	Source	Lumen Output	CCT	Weight	Code
White	22,5 mm	24 W	SMD LED	1830 lm	3000 K	1,0 kg	SOP03211
		24 W	SMD LED	1880 lm	4000 K	1,0 kg	SOP03212
	30 mm	30 W	SMD LED	2230 lm	3000 K	1,6 kg	SOP03311
		30 W	SMD LED	2400 lm	4000 K	1,6 kg	SOP03312

☐ 220÷240Vac | IP20

Versioni dimmerabili: regolazione della luminosità 0/1 - 100 % - Dimmable versions: light regulation 0/1 - 100 %

Finishes

White



PLAY



Play è realizzata in alluminio verniciato bianco opaco o nero opaco ed è dotata di schermo opalino diffondente in PMMA. Grazie alle sorgenti SMD LED integrate nel corpo dell'apparecchio, lo schermo inferiore si illumina in modo perfettamente uniforme; Play permette di ottenere effetti di luce morbida e diffusa verso il basso ed è quindi particolarmente indicata per illuminare gli ambienti con luce uniforme, perfettamente distribuita e priva di ombre dure. Play è completa di driver integrati nel corpo dell'apparecchio ed è disponibile nelle versioni con controllo On/Off o con controllo dimmerabile 1...10V, Push, DALI. Completano la gamma le versioni per luce in emergenza permanente con 1 ora di autonomia, tempo di accensione 0,5 sec. e tempo di ricarica 24 h.

Play is an aluminium ceiling mounted luminaire in matt white or matt black color painted, equipped with a diffusing opal PMMA screen. Thanks to the SMD LED sources integrated in the body of the device, the lower screen lights up perfectly evenly; Play allows to obtain soft and diffused down light effects and is therefore particularly suitable for illuminating indoor ambients with uniform light, perfectly distributed and free of harsh shadows. Play is complete with drivers integrated into the body of the device and is available in versions OnOff controlled or dimmable 1 ... 10V, Push, DALI controlled. The range is completed by versions for permanent emergency light with 1 hour autonomy, ignition time 0.5 sec. and recharging time 24 h.

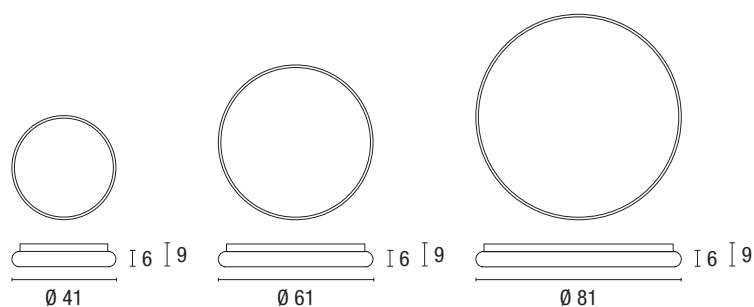

Optical Info p. 535

Model	Ø	Colours	Source	Power	Lumen Output	CCT	Weight	Code
On/Off	41 mm	White	SMD LED	38 W	2280 lm	3000 K	3,3 kg	GRF11111
		Black	SMD LED	38 W	2280 lm	3000 K	3,3 kg	GRF11121
	61 mm	White	SMD LED	62 W	3720 lm	3000 K	4,8 kg	GRF11211
		Black	SMD LED	62 W	3720 lm	3000 K	4,8 kg	GRF11221
	81 mm	White	SMD LED	100 W	6000 lm	3000 K	7,7 kg	GRF11311
		Black	SMD LED	100 W	6000 lm	3000 K	7,7 kg	GRF11321
Dimmerabile DALI / 1...10 V / Push	41 mm	White	SMD LED	38 W	2280 lm	3000 K	3,3 kg	GRF11111DM
		Black	SMD LED	38 W	2280 lm	3000 K	3,3 kg	GRF11121DM
	61 mm	White	SMD LED	62 W	3720 lm	3000 K	4,8 kg	GRF11211DM
		Black	SMD LED	62 W	3720 lm	3000 K	4,8 kg	GRF11221DM
	81 mm	White	SMD LED	100 W	6000 lm	3000 K	7,7 kg	GRF11311DM
		Black	SMD LED	100 W	6000 lm	3000 K	7,7 kg	GRF11321DM
Emergenza 1 h.	41 mm	White	SMD LED	in emergency mode 450 lm	3000 K	3000 K	3,3 kg	GRF11111H1
		Black	SMD LED	in emergency mode 450 lm	3000 K	3000 K	3,3 kg	GRF11121H1
	61 mm	White	SMD LED	in emergency mode 450 lm	3000 K	3000 K	4,8 kg	GRF11211H1
		Black	SMD LED	in emergency mode 450 lm	3000 K	3000 K	4,8 kg	GRF11221H1
	81 mm	White	SMD LED	in emergency mode 450 lm	3000 K	3000 K	7,7 kg	GRF11311H1
		Black	SMD LED	in emergency mode 450 lm	3000 K	3000 K	7,7 kg	GRF11321H1

 220÷240Vac | IP20

Versioni dimmerabili: regolazione della luminosità 0/1 - 100 % - Dimmable versions: light regulation 0/1 - 100 %

Finishes

White

Black



DAMA



Di forma quadrata, Dama è realizzata in alluminio verniciato bianco opaco o nero opaco; è dotata di schermo opalino diffondente in PMMA e, grazie alle sorgenti SMD LED integrate nel corpo dell'apparecchio, si illumina in modo perfettamente uniforme; Dama permette di ottenere effetti di luce morbida e diffusa verso il basso ed è quindi particolarmente indicata per illuminare gli ambienti con luce uniforme, perfettamente distribuita e priva di ombre dure. Dama è completa di driver integrati nel corpo dell'apparecchio ed è disponibile nelle versioni con controllo On/Off o con controllo dimmerabile 1...10V, Push, DALI. Completano la gamma le versioni per luce in emergenza permanente con 1 ora di autonomia, tempo di accensione 0,5 sec. e tempo di ricarica 24 h.

Designed in a square shape, Dama is made of matt white or matt black painted aluminium; it is equipped with an opal diffusing screen in PMMA and, thanks to the SMD LED sources integrated in the body of the luminaire, it lights up perfectly evenly; Dama allows to obtain soft and diffused down light effects and is therefore particularly suitable for illuminating indoor ambients with uniform light, perfectly distributed and free of harsh shadows. Dama is complete with drivers integrated into the body of the device and is available in versions On/Off controlled or dimmable 1...10 V, Push, DALI controlled. The range is completed by versions for permanent emergency light with 1 hour autonomy, ignition time 0.5 sec. and charging time 24 h.

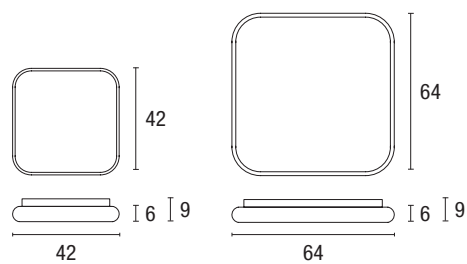

Optical Info p. 535

Model	Dimention	Colours	Source	Power	Lumen Output	CCT	Weight	Code
On/Off	42 x 42 mm	White	SMD LED	38 W	2280 lm	3000 K	3,8 kg	GRF12111
	42 x 42 mm	Black	SMD LED	38 W	2280 lm	3000 K	3,8 kg	GRF12121
	64 x 64 mm	White	SMD LED	62 W	3720 lm	3000 K	6,1 kg	GRF12211
	64 x 64 mm	Black	SMD LED	62 W	3720 lm	3000 K	6,1 kg	GRF12221
Dimmerabile DALI / 1...10 V / Push	42 x 42 mm	White	SMD LED	38 W	2280 lm	3000 K	3,8 kg	GRF12111DM
	42 x 42 mm	Black	SMD LED	38 W	2280 lm	3000 K	3,8 kg	GRF12121DM
	64 x 64 mm	White	SMD LED	62 W	3720 lm	3000 K	6,1 kg	GRF12211DM
	64 x 64 mm	Black	SMD LED	62 W	3720 lm	3000 K	6,1 kg	GRF12221DM
Emergenza 1 h.	42 x 42 mm	White	SMD LED	in emergency mode 450 lm	3000 K	3,8 kg		GRF12111H1
	42 x 42 mm	Black	SMD LED	in emergency mode 450 lm	3000 K	3,8 kg		GRF12121H1
	64 x 64 mm	White	SMD LED	in emergency mode 450 lm	3000 K	6,1 kg		GRF12211H1
	64 x 64 mm	Black	SMD LED	in emergency mode 450 lm	3000 K	6,1 kg		GRF12221H1

220÷240Vac | IP20

Versioni dimmerabili: regolazione della luminosità 0/1 - 100 % - Dimmable versions: light regulation 0/1 - 100 %

Finishes

White

Black



URANO_Ceiling

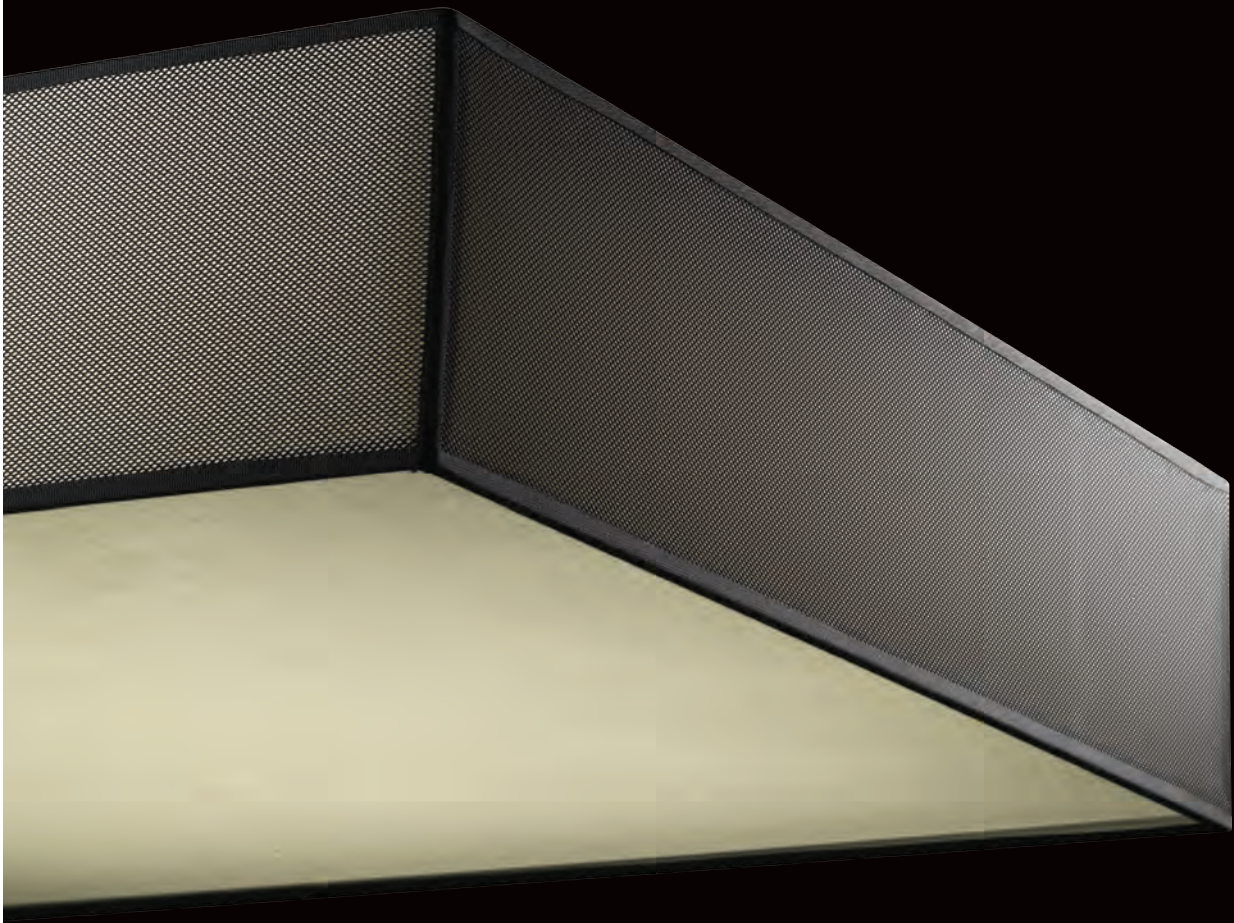



p.314

Urano si installa a plafone o a sospensione; è composto da un pannello a led e un paralume in tessuto completo di schermo in pergamena traslucida. Permette di ottenere effetti di luce estremamente confortevoli grazie all'abbinamento del pannello di tipo "edge led" con la pergamena diffondente. Disponibile in diverse misure e potenze, si installa a sospensione grazie ai cavetti in acciaio rivestito con guaina trasparente; l'altezza di sospensione è regolabile con sistema autobloccante "grip lock" fino ad una altezza massima di 350 cm.; la versione a plafone è completa di staffe di fissaggio a soffitto. Cavo di alimentazione in FEP+PVC trasparente.

Urano is a ceiling mounting or pendant luminaire; it is composed of a LED panel and a fabric shade complete with a translucent parchment screen. It allows to obtain extremely comfortable lighting effects thanks to the combination of the "edge led" type panel with the diffusing parchment. Urano can be installed as pendant up to 350 cm thanks to four steel cables covered with transparent sheath, adjustable in height with self-locking "grip lock" system; the ceiling mounted version is complete with ceiling fixing brackets. Power cable in FEP + PVC transparent.

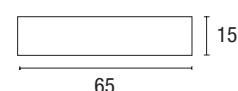

Description	Colour	Power	Source	Lumen Output	CCT	Weight	Code
35 x 35 cm	Bordeaux	18 W	LED Panel	1200 lm	3000K	2,8 kg	GRF15102
	Black Net	18 W	LED Panel	1100 lm	3000K	2,8 kg	GRF15103
65 x 65 cm	Bordeaux	36 W	LED Panel	2200 lm	3000K	3,8 kg	GRF15202
	Black Net	36 W	LED Panel	1950 lm	3000K	3,8 kg	GRF15203

☐ 220÷240Vac | IP20

Lamp not included

Lampshade finish

Bordeaux

Black Net



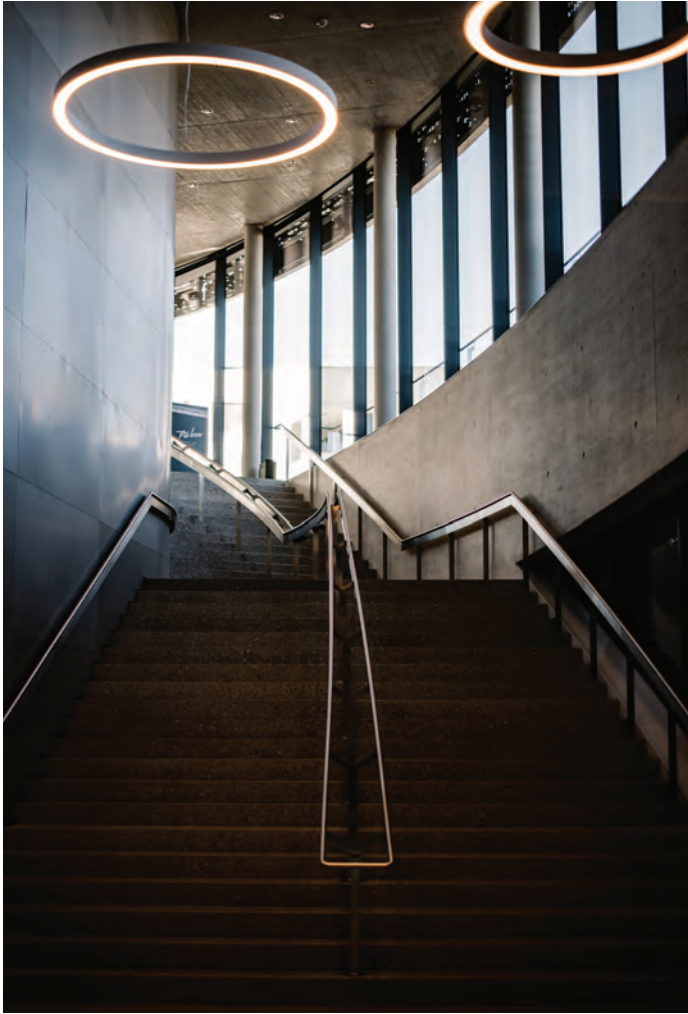

PENDANTS

05

I N D E X

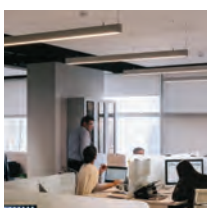

Karma_p.268



Maya_p.276



Maya Mini_p.284



Bahia_p.288



Hoop_p.290



Corona_p.292



Bike_p.294



Penny_p.296



Kart_p.298



Infinity_p.300



Lunar_p.302



Cross_p.304

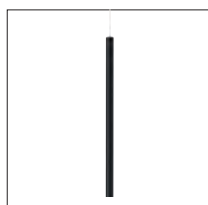

Stek_p.306



Lupin_p.308



Giove_p.310



Saturno_p.312



Urano_p.314

KARMA_Pendant

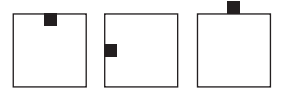

Karma sospensione è l'elemento centrale della gamma. L'apparecchio è disponibile in diverse misure, colori, ottiche secondo necessità, gestioni elettroniche che prevedono ON-OFF, DALI, Push, Casambi. Un progetto che rimane valido nel tempo si qualifica per l'insieme dei dettagli disponibili senza alterare l'estetica del prodotto: singola o doppia emissione, gruppi emergenza, accensioni separate. Affidabilità e componentistica ai massimi livelli sono i punti di forza della linea Karma. Si possono scegliere elementi da installare in versione stand alone oppure configurazioni, anche complesse, che includono linee continue ed angoli. Un configuratore on line permette la selezione del prodotto desiderato in maniera rapida e semplice.

Karma suspension is the central element of the range. The device is available in different sizes, colors, optics as needed, electronic management that provide ON-OFF, DALI, Push, Casambi. A project that remains valid over time qualifies for the set of details available without altering the aesthetics of the product: single or double emissions, emergency groups, double switch. Reliability and components at the highest levels are the strengths of the Karma line. You can choose elements to be installed in stand alone version or configurations, even complex, which include continuous lines and angles. An online configurator allows quick and easy selection of the desired product.



+ KARMA Ceiling pag 220

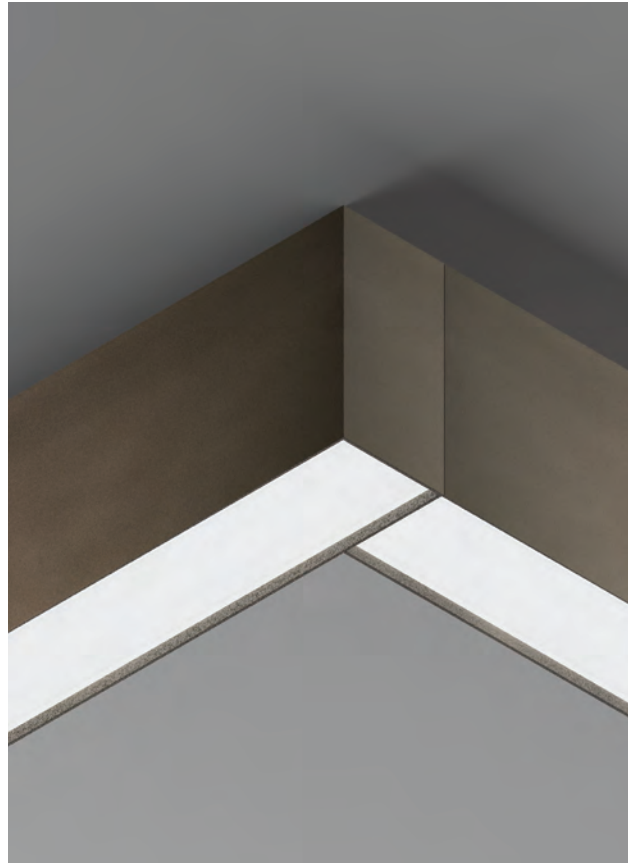

+ KARMA Recessed pag 056



+ KARMA Wall pag 326

**EXTENDED
COLLECTION**

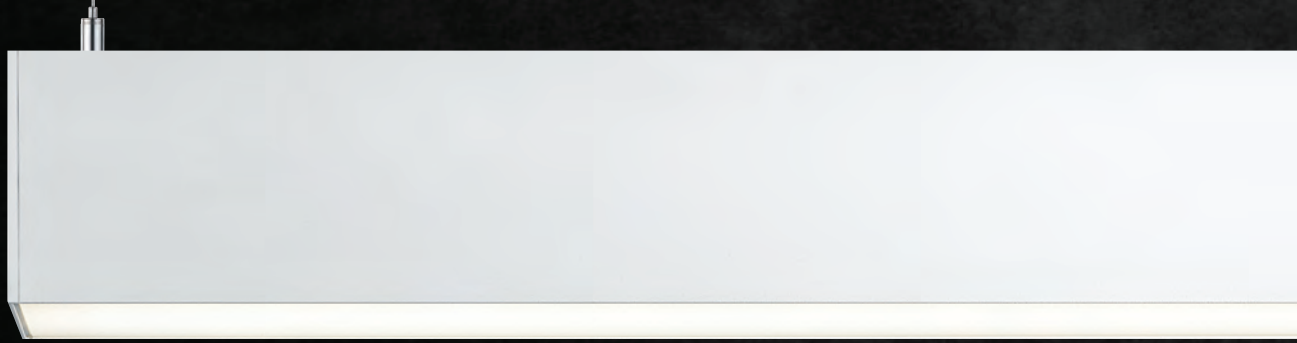

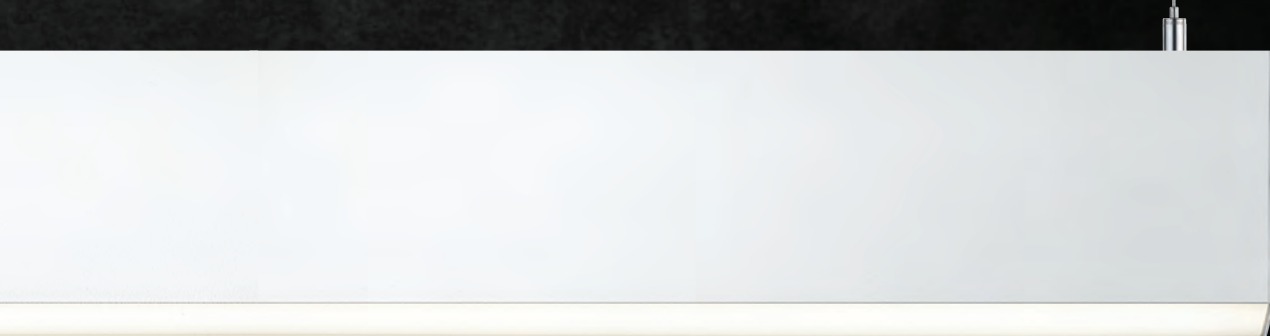

KARMA_Pendant



CONFIGURATOR

Karma_Pendant

Installation

Karma si installa in fila continua grazie al particolare giunto meccanico che, grazie alle sue viti di regolazione, permette di allineare perfettamente i singoli moduli strutturali. Agendo sulle viti di regolazione dei giunti meccanici si allineano i moduli strutturali fra loro, ottenendo così una migliore installazione. Gli appositi fast-plug garantiscono la connessione elettrica fra i moduli strutturali precablati senza bisogno di utilizzare utensili.

Karma can be installed in a continuous line thanks to the mechanic joint that, thanks to its adjustment screws, allows the individual rail modules to be perfectly aligned. Acting on the adjustment screws of the mechanical joints and aligning the rail modules together, thus obtaining a better installation. The special fast-plugs require the electrical connection between pre-wired modules without tools.

- 1 - Inserimento del giunto meccanico fra i moduli strutturali
Inserting mechanical joint between the rail modules
- 2 - Accoppiamento dei moduli strutturali
Matching of rail modules
- 3 - Fissaggio e allineamento dei moduli strutturali grazie alle apposite viti di regolazione
Fixing and alignment of the rail modules thanks to the appropriate adjustment screws

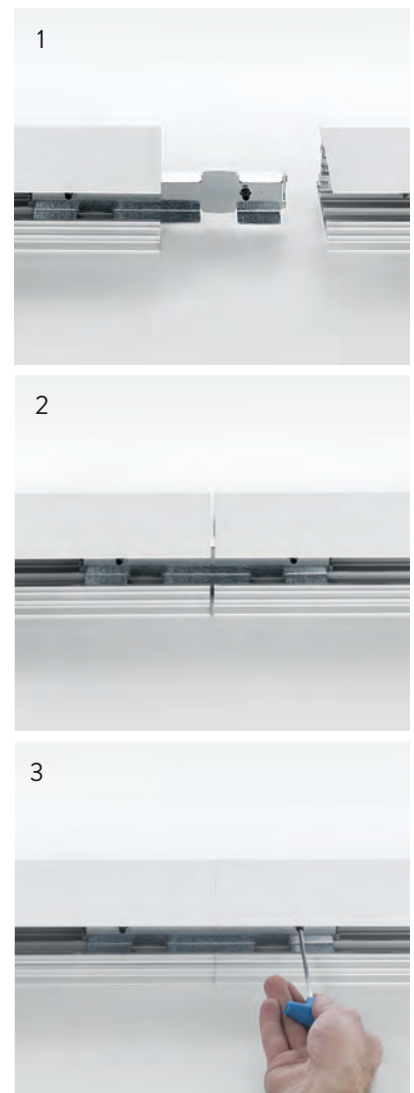

- Cavo di sospensione in acciaio e regolazione dell'altezza di sospensione con sistema "grip-lock".
Adjustable steel pendant with "grip-lock" system.
- Il "nipple" è posizionato sulla parte superiore dell'apparecchio anziché a soffitto per facilitare la fase regolazione.
The suspension nipple is located on the luminaire instead to the ceiling in order to make easy the height regulation.
- La portata massima di ogni kit di sospensione è di 12kg.
Each pendant kit is max.12kg strenght.

L'installazione di Karma è rapida, semplice ed intuitiva; una volta fissati a soffitto i moduli strutturali già precablati, si montano i moduli ottici con un semplice click grazie al sistema di fissaggio magnetico incorporato. Il collegamento elettrico dei moduli ottici è in bassissima tensione e avviene senza utensili grazie all'apposito "fast plug". Il sistema di regolazione della lunghezza del cavo di sospensione è facilmente accessibile perché collocato direttamente sul modulo strutturale.

The installation of Karma is quick, simple and intuitive; once the pre-wired rail modules are fixed to the wall, the optical modules are mounted with a simple click thanks to the built-in magnetic fixing system. The electrical connection of the optical modules is in very low voltage and without tools thanks to the special "fast plug". The suspension cable length adjustment system is easily accessible because it is placed directly on the rail module.

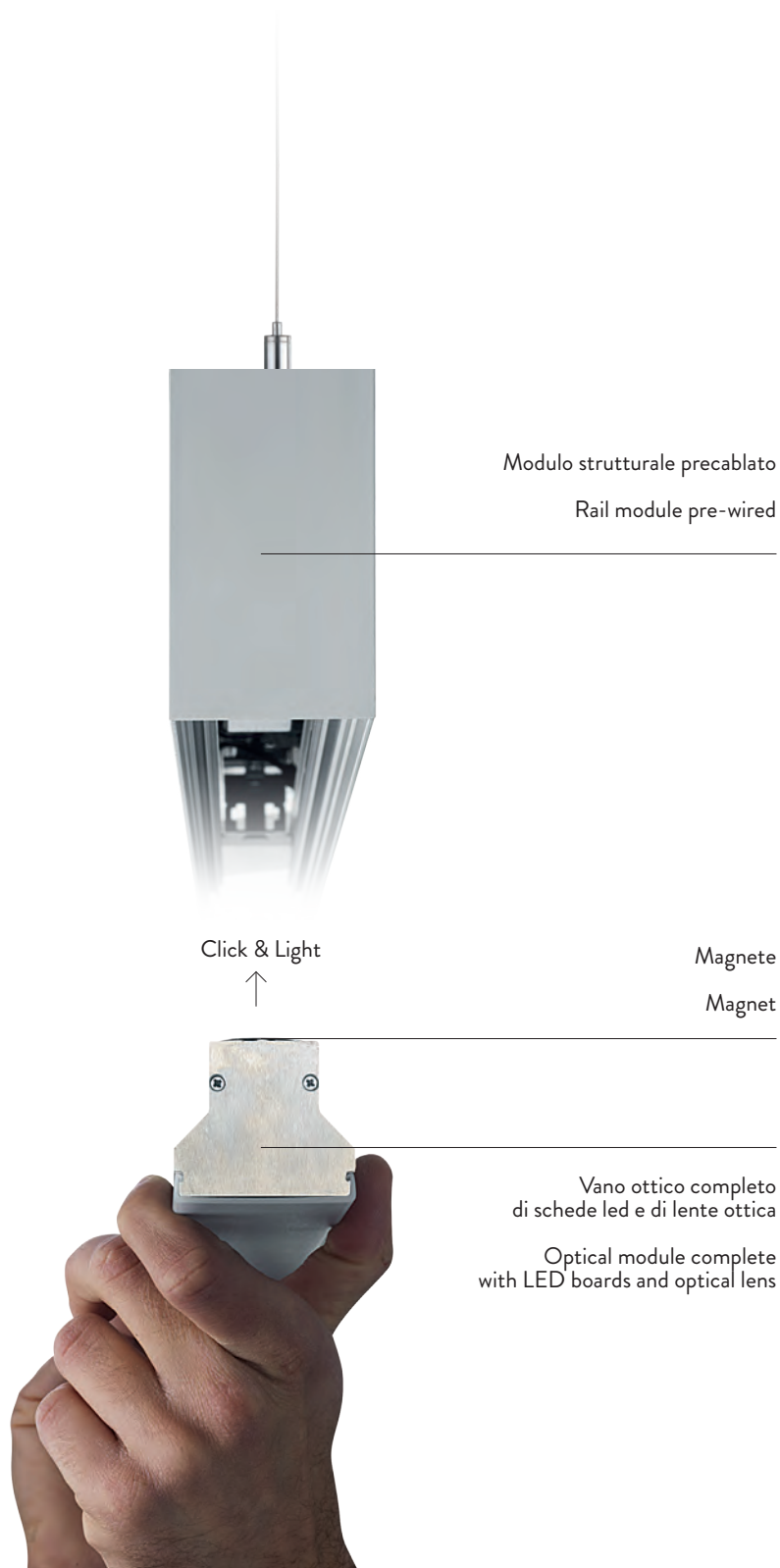

KARMA_Pendant

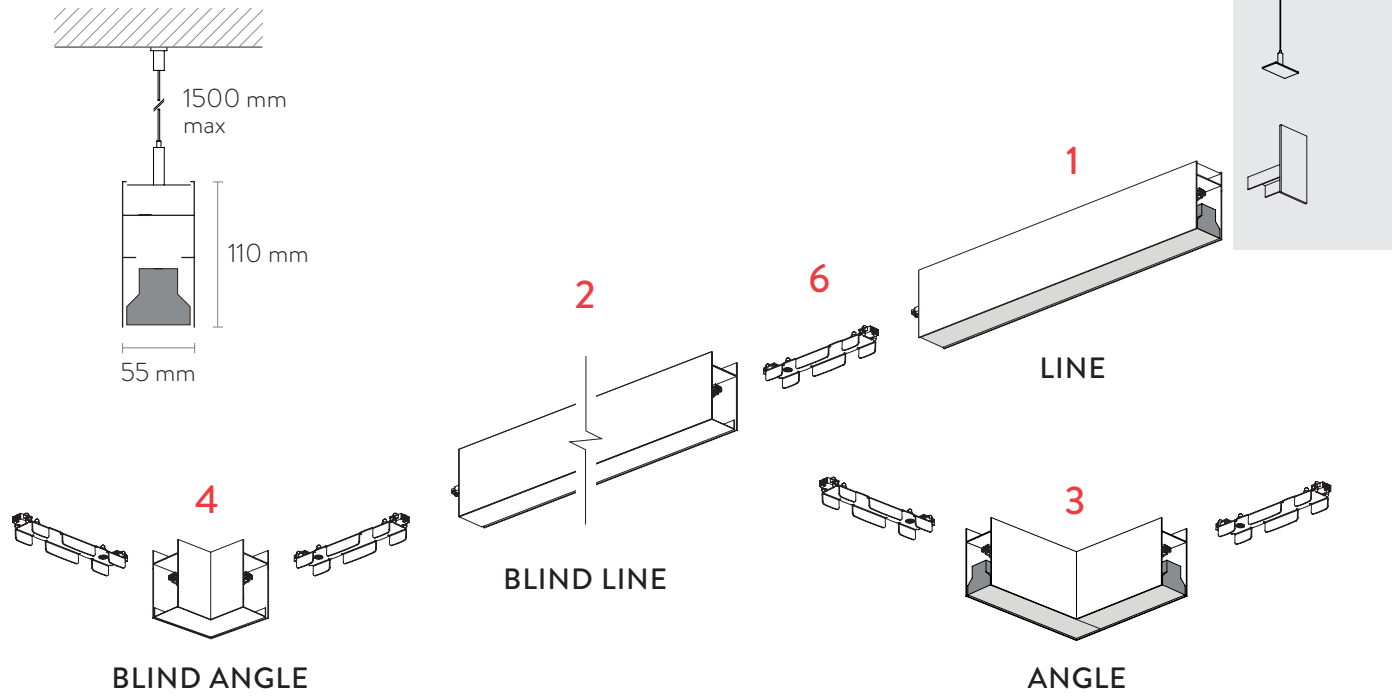

1 Line

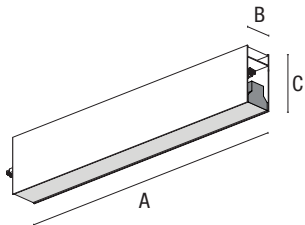

Downlight

Model	Power	Lumen output		Product dimension			* code to complete
		downlight	uplight	A	B	C	
600 (No Tunable)	12 W	1879 lm	/	573 mm	55 mm	110 mm	SE-HAAAA ■ ▲ ● □
1100	24 W	3758 lm	/	1131 mm	55 mm	110 mm	SE-HAABC ■ ▲ ● □
1700	36 W	5637 lm	/	1691 mm	55 mm	110 mm	SE-HAACD ■ ▲ ● □
2200	48 W	7516 lm	/	2250 mm	55 mm	110 mm	SE-HAADE ■ ▲ ● □

Downlight_Uplight

600	12+4 W	1879 lm	/	573 mm	55 mm	110 mm	SE-HABAB ■ ▲ ● □
1100	24+12 W	3758 lm	/	1131 mm	55 mm	110 mm	SE-HABBD ■ ▲ ● □
1700	36+12 W	5637 lm	/	1691 mm	55 mm	110 mm	SE-HABCE ■ ▲ ● □
2200	48+24 W	7516 lm	/	2250 mm	55 mm	110 mm	SE-HABDG ■ ▲ ● □

Downlight_Uplight
Dual switch

1100	24+12 W	3758 lm	1320 lm	1131 mm	55 mm	110 mm	SE-HACBD ■ ▲ ● □
1700	36+12 W	5637 lm	1320 lm	1691 mm	55 mm	110 mm	SE-HACCE ■ ▲ ● □
2200	48+24 W	7516 lm	2640 lm	2250 mm	55 mm	110 mm	SE-HACDG ■ ▲ ● □

⊕ 220÷240Vac | IP40

UP to 157 lm/W | UP to UGR≥19 | L80/B20 80.000 h. | CRI>90 | UP to RG0 | SDCM<3
Lumen output values: luminaire luminous flux at 4000 K - optics 60°

2 Blind Line

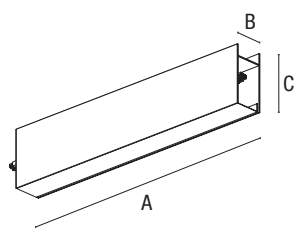

Model	Power	Lumen output	Product dimension			* code to complete
			A	B	C	
600	/	/	573 mm	55 mm	110 mm	SE-HAEA ●
1100	/	/	1131 mm	55 mm	110 mm	SE-HAEB ●
1700	/	/	1691 mm	55 mm	110 mm	SE-HAEC ●

3 Angle Downlight

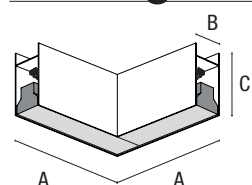

Model	Power	Lumen output	Product dimension			* code to complete
			A	B	C	
600x600	24 W	2705 lm	600 mm	55 mm	110 mm	SE-HFAMC ■ ▲ ● □

⊕ 220÷240Vac | IP40

UP to 112 lm/W | UP to UGR≥19 | L80/B20 80.000 h. | CRI>90 | RG0 | SDCM<3
Lumen output values: luminaire luminous flux at 4000 K - Only 120° optics

4 Blind Angle

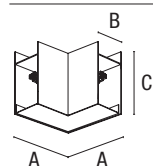

Model	Power	Lumen output	Product dimension			* code to complete
			A	B	C	
250x250	/	/	250 mm	55 mm	110 mm	SE-HFEZ ●

5 Accessories

Description	* code to complete
Canopy - 3x0,75 (On/Off - Casambi)	CSS01 ● :: T
Canopy - 5x0,75 (DALI - Push)	CSS02 ● :: T
Canopy - 3x1,5 (On/Off - Casambi)	CSS03 ● :: T
Canopy - 5x1,5 (DALI - Push)	CSS04 ● :: T
Hanger (2x line 300, 600, 1100 - 3x line 1700, 2200, 3x angle)	CSPP01 ◐ ::
End Cap (2x)	AT ● 07301

6 Joint

Description	code
Metal connection	ATS03303

Optical Info p. 528

* Select your option

CCT	Optic	Colour	Control	Pendant colour	Steel cable length	#
2700 K	60°	White	On/Off	Steel	1,5	Only: 120° - DALI(DT8), Casambi
3000 K	90°	Black	DALI	Black	3	** Only: 1700 - 2200
4000 K	120°	Corten	Em. 1h **		5	*** Configurations up to max 2800 mm length
Tunable # %	Asy	Lunar Grey	Casambi ****			% Only: 1100 - 1700 - 2200
	Sym	Tobacco	Push ***			

Finishes

White

Black

Corten

Lunar Grey

Tobacco



MAYA_Pendant



Maya Pendant occupa un posto di rilievo nella gamma Maya. In versione stand alone oppure un sistema continuo, Maya Pendant esprime al meglio design curato, efficienza tecnologica ed estetica del progetto. Diverse le lunghezze del profilo che attraverso giunti ed angoli permette di disegnare la configurazione desiderata in piena libertà. La gestione elettronica è affidata a componenti di primissimo livello in grado di garantire le migliori prestazioni per efficienza e stabilità nel tempo. È coperta l'intera gamma di alimentazione: On/Off, Dali, Push, Casambi. Maya impiega schede Led ad alta efficienza nelle varianti 2700K, 3000K e 4000K nonché una versione tunable white. Vasta la paletta colori che include varianti iconiche e fuori dai modelli tradizionali di verniciatura. On line è attivo un configuratore specifico che semplifica le scelte del prodotto ed i suoi accessori.

Maya Pendant holds a prominent position in the Maya range. Whether as a stand-alone or continuous system, Maya Pendant embodies well-designed aesthetics, technological efficiency, and project aesthetics. There are different lengths of the profile that allow for the freedom to create the desired configuration through joints and angles. The electronic management relies on top-quality components capable of guaranteeing the best performance in terms of efficiency and long-term stability. The entire range of power supply options is covered: On/Off, Dali, Push, Casambi. Maya utilizes high-efficiency LED boards in 2700K, 3000K, and 4000K variants, as well as a tunable white version. The color palette is extensive and includes iconic variations beyond traditional paint finishes. An online configurator is available to simplify product choices and accessories.



MODEL

300

600

1100

1700

2200

2800

+ MAYA Wall pag 332



+ MAYA Ceiling pag 226



EXTENDED COLLECTION



+ MAYA Track pag 212



+ MAYA Recessed pag 062

MAYA_Pendant

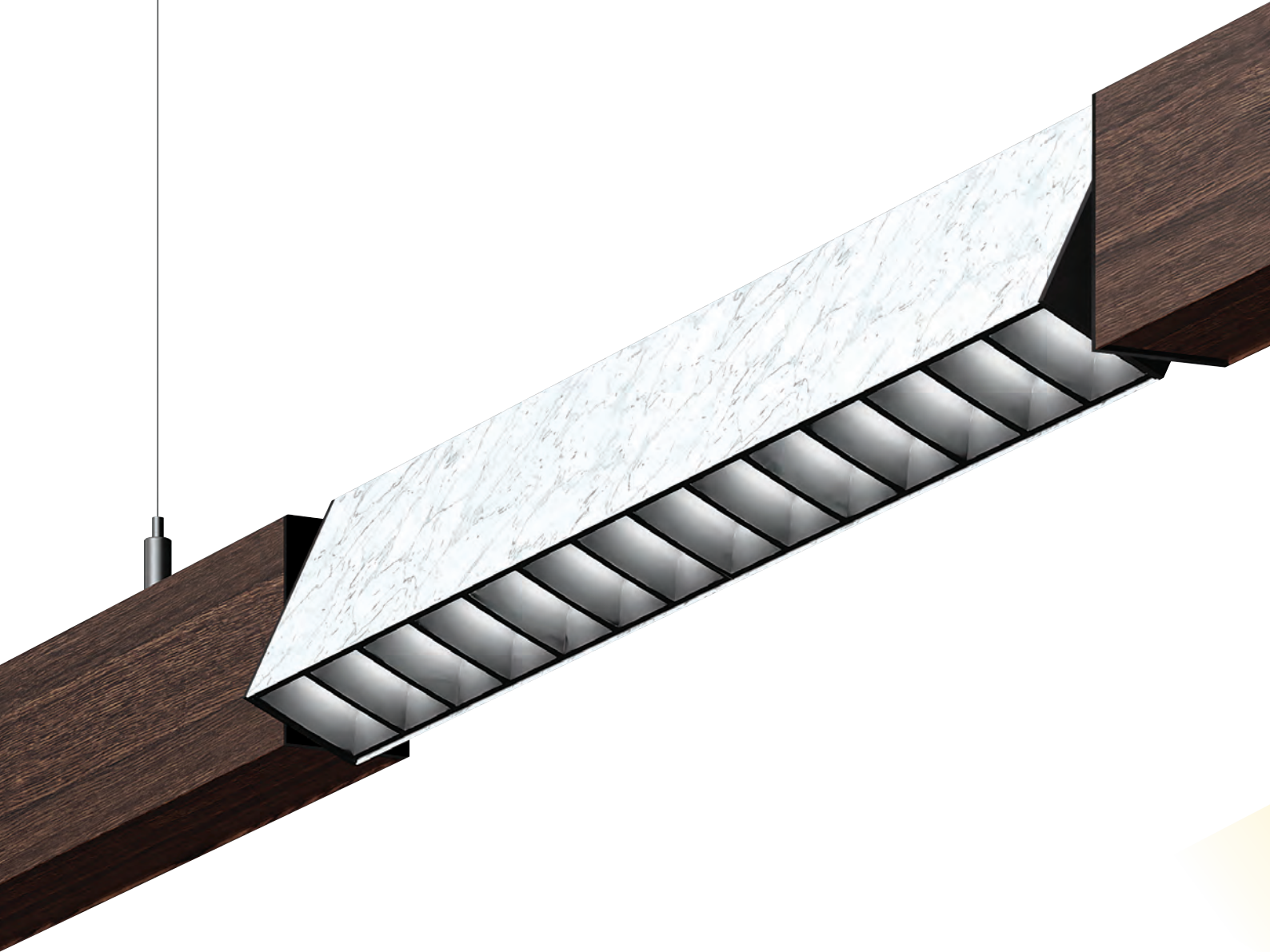

Pendant_ADJ

Il modello Maya_Adj rappresenta un ulteriore elemento di qualità progettuale del sistema. Questo componente, solitamente combinato con ottiche e riflettori, permette l'orientamento del flusso luminoso (120°). L'impiego di Maya_Adj in combinazione con lo sviluppo lineare del sistema lascia inalterata l'estetica minimale dell'intero impianto. La bancata ottica è disponibile nelle misure 300, 600 e 900mm.

Maya_Adj represents an additional element of design quality of our system. This specific component, usually combined with optics and reflectors, provides the adjustable luminous flux (120°). Maya_Adj combine with the linear development of the system lets unaffected the minimal esthetic of the entire facility. This model is available in 300, 600 and 900 mm length.

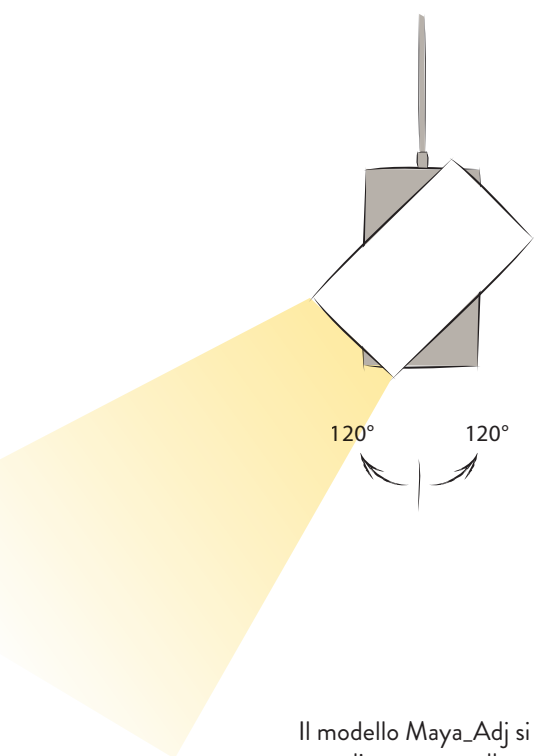

Il modello Maya_Adj si inserisce semplicemente nello sviluppo della linea luminosa. Il codice prevede la fornitura di tutti i componenti utili all'installazione.

The Maya_Adj model fits easily in the development of the light line. The single code include all components for installation.



MAYA_Pendant

OVERVIEW

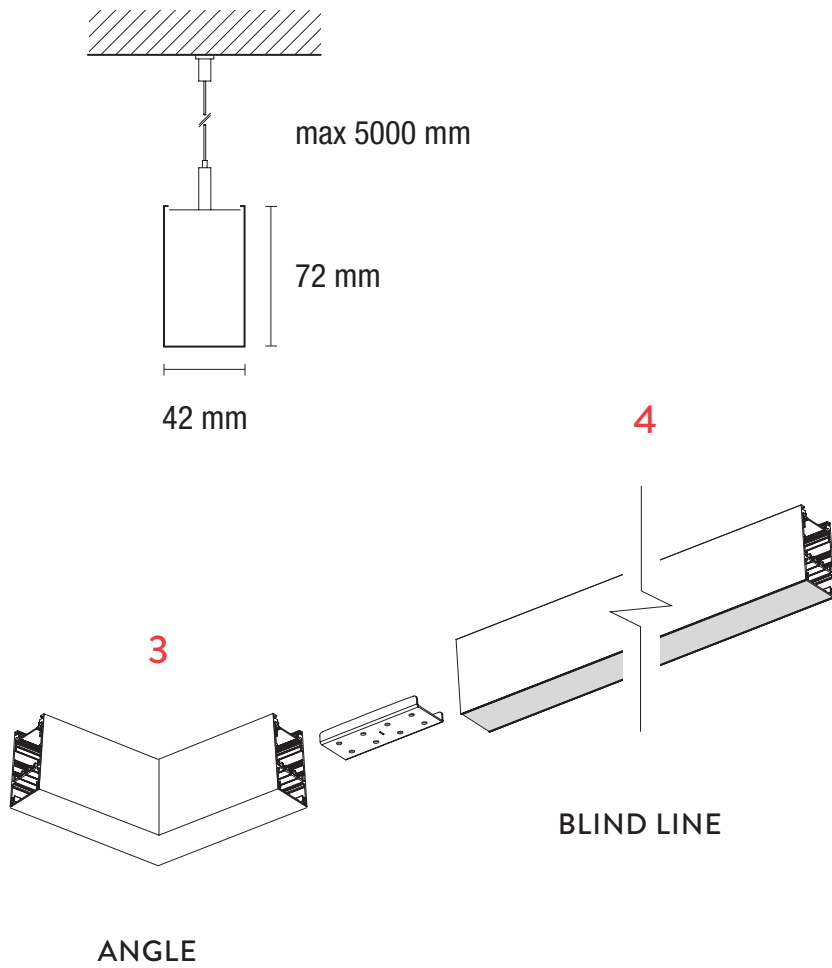

6

JOINT

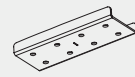

Metal connection



L



T



120°

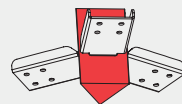

Y

1

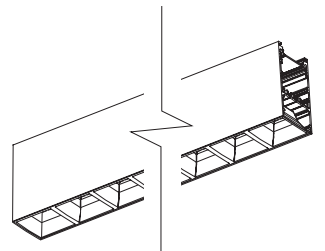

LINE

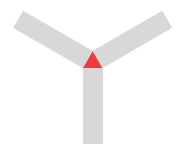
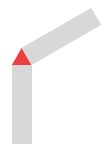
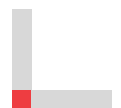

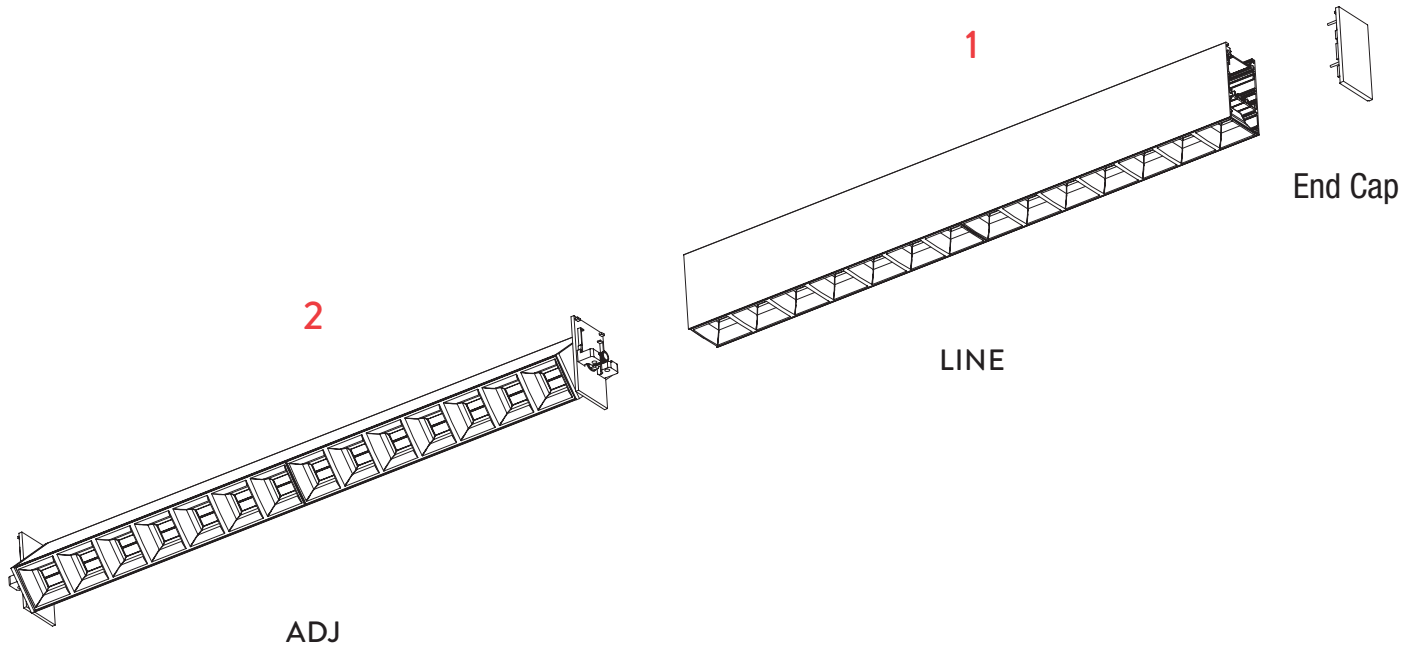

ACCESSORIES

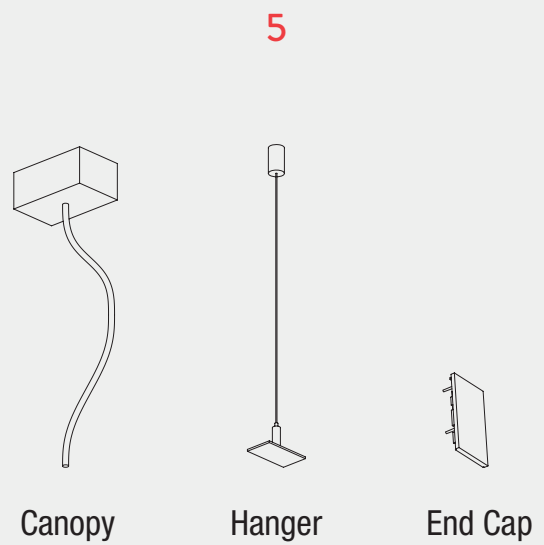

The version
is available
for desktop

MAYA_Pendant

1 Line

	Length	Power	Lumen output		* code to complete
			downlight	uplight	
Downlight	600	12 W	1518 lm	-	SM-HAAAA ■ △ ● □
	1100	24 W	3036 lm	-	SM-HAABC ■ △ ● □
	1700	36 W	4554 lm	-	SM-HAACD ■ △ ● □
	2200	48 W	6072 lm	-	SM-HAADE ■ △ ● □
	2800	60 W	7590 lm	-	SM-HAAWF ■ △ ● □
Downlight_Uplight	600	12+6 W	1518 lm	475 lm	SM-HABAB ■ △ ● □
	1100	24+12 W	3036 lm	897 lm	SM-HABBD ■ △ ● □
	1700	36+12 W	4554 lm	897 lm	SM-HABCE ■ △ ● □
	2200	48+24 W	6072 lm	1795 lm	SM-HABDG ■ △ ● □
	2800	60+36 W	7590 lm	2692 lm	SM-HABWJ ■ △ ● □
Downlight_Uplight Dual switch	1100	24+12 W	3036 lm	897 lm	SM-HACBD ■ △ ● □
	1700	36+12 W	4554 lm	897 lm	SM-HACCE ■ △ ● □
	2200	48+24 W	6072 lm	1795 lm	SM-HACDG ■ △ ● □
	2800	60+36 W	7590 lm	2692 lm	SM-HACWJ ■ △ ● □

⊕ 220÷240Vac | IP40

UP to 127 lm/W | UP to UGR≥16 | L80/B20 80.000 h. | CRI>90 | UP to RG0 | SDCM<3
Lumen output values: luminaire luminous flux at 4000 K - optics 50°

2 Adj

	Length	Power	Lumen output	* code to complete
Downlight	300 (System Mono Switch only)	6 W	760 lm	SM-HLAVQ ■ △ ● □
	600 (System Mono Switch only)	12 W	1518 lm	SM-HLAAA ■ △ ● □

⊕ 220÷240Vac | IP40

UP to 127 lm/W | UP to UGR≥16 | L80/B20 80.000 h. | CRI>90 | UP to RG0 | SDCM<3
Lumen output values: luminaire luminous flux at 4000 K - optics 50°

3 Angle

	Length	Power	Lumen output	* code to complete
Downlight	600x600	24 W	3036 lm	SM-HFAMC ■ △ ● □

⊕ 220÷240Vac | IP40

UP to 105 lm/W | UGR≥19 | L80/B20 80.000 h. | CRI>90 | UP to RG0 | SDCM<3
Lumen output values: luminaire luminous flux at 4000 K - optics MICRO

Optical Info p. 528

* Select your option

CCT	Optic	Colour	Control	#
2700 K	120°	White	On/Off	Only: 120° - DALI(DT8), Casambi
3000 K	Micro	Black	DALI	** Only: 1700 - 2200 - 2800
4000 K	50° White	Corten	Em. 1h **	*** Configurations up to max 2800 mm length
Tunable #	50° Black	Lunar Grey	Casambi	
	80° White	Tobacco	Push ***	
	80° Black	Magma Red		
	Asy White	Capri Blue		
	Asy Black	Beech Wood		
		Oak Wood		
		Walnut Wood		
		Antique Marble		

MAYA_Pendant

4 Blind line

Description	* code to complete
300	SM-HAEV ●
600	SM-HAEA ●
1100	SM-HAEB ●
1700	SM-HAEC ●
2200	SM-HAED ●

5 Accessories

Description	* code to complete
Canopy - 3x0,75 (On/Off - Casambi)	CSS01 ▼ :: T
Canopy - 5x0,75 (DALI - Push)	CSS02 ▼ :: T
Canopy - 3x1,5 (On/Off - Casambi)	CSS03 ▼ :: T
Canopy - 5x1,5 (DALI - Push)	CSS04 ▼ :: T
Hanger (2x line 300, 600, 1100 - 3x line 1700, 2200, 2800 - 3x angle)	CSPP00 ⚙ ::
End Cap (2x)	CS ▼ 07301

6 Joint

Description	* code to complete
L	CS ▼ 03312
T	CS ▼ 03313
120°	CS ▼ 03310
Y	CS ▼ 03311
Metal connection	CSS03303

* Select your option

Colour ●	Pendant colour ⚙	Steel cable length ::	Accessories + Joint colour ▼
White W	Steel A	1,5 1	White W
Black B	Black B	3 2	Black B
Corten C		5 3	Corten C
Lunar Grey G			Grey G
Tobacco O			Tobacco O
Magma Red R			Magma Red R
Capri Blue D			Capri Blue D
Beech Wood H			Sand V
Oak Wood I			Sage Green U
Walnut Wood L			
Antique Marble S			

MAYA_mini Pendant

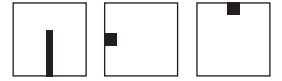

Maya_Mini in configurazione sospensione esalta le ridotte dimensioni del profilo e ne aumenta attrattiva e funzionalità. Questa soluzione offre una vasta scelta su tipologia e dimensioni mantenendo l'esclusività su finiture e prestazioni. Modelli disponibili 1100 - 1700 - 2200. Tante le tipologie funzionali: emissione flusso luminoso Up down, colori della scheda led, ottiche, dimmerazioni. A queste infinite variabili si aggiunge la scelta della gamma colori. Oltre i classici bianco e nero si spazia in combinazioni accattivanti facilmente selezionabili con il configuratore dedicato.

Maya_Mini in suspension configuration enhances the compact profile size and increases its attractiveness and functionality. This solution offers a wide selection of types and sizes while maintaining exclusivity in finishes and performance. Models available 1100 - 1700 - 2200. There are many functional options available, such as up-down light emission, LED board colors, optics, and dimming capabilities. In addition to these countless variables, there is also a choice of color range. Beyond the classic white and black, there are captivating combinations easily selectable with the dedicated configurator.



+ MAYA_mini Ceiling pag 234



+ MAYA_mini Floor pag 402



EXTENDED COLLECTION

+ MAYA_mini Wall/Ceiling pag 340

MAYA_mini Pendant

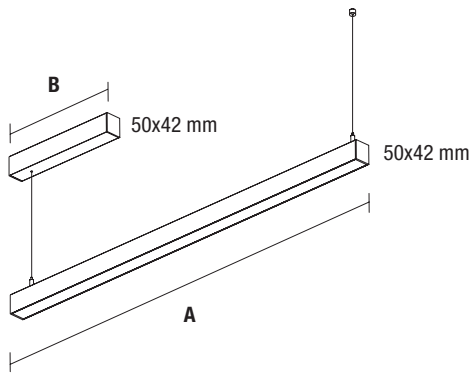

	Model	Power	Lumen output		Product dimension		* code to complete
			downlight	uplight	A	B	
Downlight	1100	24 W	3036	-	1126 mm	560 mm	MM-SABC ■ △ □ ● ☼ ▼
	1700	36 W	4554	-	1686 mm	560 mm	MM-SACD ■ △ □ ● ☼ ▼
	2200	48 W	6072	-	2246 mm	560 mm	MM-SADE ■ △ □ ● ☼ ▼
Downlight_Uplight	1100	24+12 W	3036	897	1126 mm	560 mm	MM-SBBD ■ △ □ ● ☼ ▼
	1700	36+12 W	4554	897	1686 mm	560 mm	MM-SBCE ■ △ □ ● ☼ ▼
	2200	48+24 W	6072	1795	2246 mm	1100 mm	MM-SBDG ■ △ □ ● ☼ ▼

⊕ 220÷240Vac | IP40 UP to 127 lm/W | UP to UGR≥16 | L80/B20 80.000 h. | CRI>90 | UP to RG0 | SDCM<3
Lumen output values: luminaire luminous flux at 4000 K - optics 50°

Optical Info p. 528

* Select your option

CCT	■	Optic	△	Control	□	Structure colour	●	Canopy colour	☼	End Cap colour	▼
2700 K	1	120°	E	On/Off	NF	White	W	White	W	White	W
3000 K	2	Micro	M	DALI	DA	Black	B	Black	B	Black	B
4000 K	3	50° White	N	Casambi	CA	Lunar Grey	G	Lunar Grey	G	Sand	V
		50° Black	O	Push	PU	Tobacco	O	Tobacco	O	Tobacco	O
		80° White	P			Old Zebra	M	Old Zebra	M	Gray	G
		80° Black	Q			Green Grass	N	Green Grass	N	Sage Green	U
						Oman Red	P	Oman Red	P	Orange Fluo	A
						Desert Camouflage	Q	Desert Camouflage	Q		
						Beech Wood	H	Beech Wood	H		
						Oak Wood	I	Oak Wood	I		
						Walnut Wood	L	Walnut Wood	L		
						Antique Marble	S	Antique Marble	S		
						Concrete	T	Concrete	T		

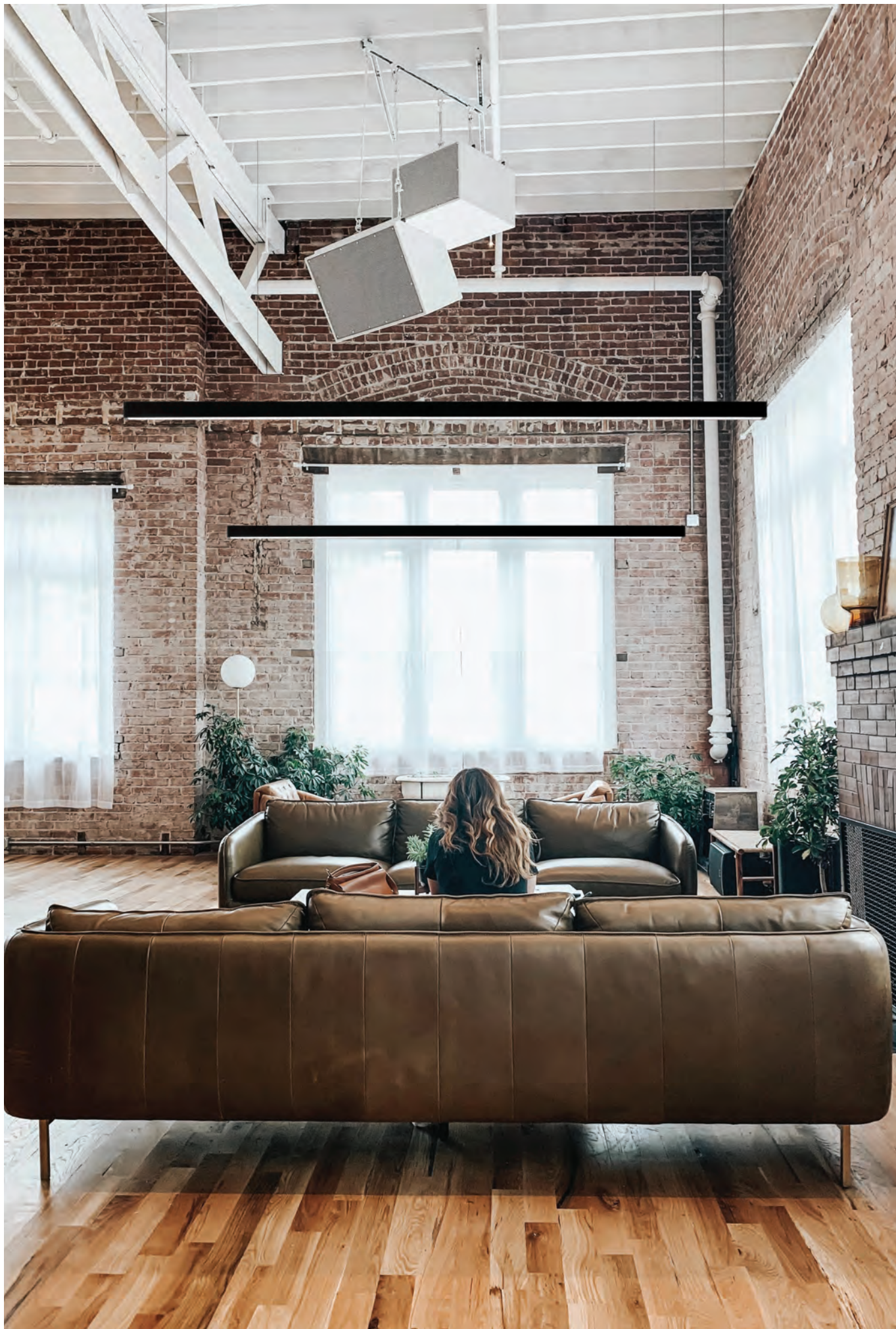

BAHIA



La sospensione di forma circolare è realizzata in estrusione di alluminio verniciato. Colori disponibili bianco e nero opaco. Lo schermo in PMMA garantisce l'emissione ottimale dei flussi luminosi emessi dalla scheda LED. L'apparecchio è regolabile in altezza attraverso i 3 cavi in acciaio con sistema meccanico di fissaggio (grip-lock). Il driver, ad alta efficienza, è integrato nel rosone a soffitto. Sono disponibili versioni dimmerabili multifunzione con controllo 1...10V, Push, DALI.

The circular suspension is made of painted aluminum extrusion. Available colors white and matt black. The PMMA screen guarantees the optimal emission of LED board luminous fluxes. The device is adjustable in height through the 3 steel cables with a mechanical fixing system (grip-lock). The high efficiency driver is integrated in the canopy. Multifunction dimmable versions with 1... 10V, Push, DALI.

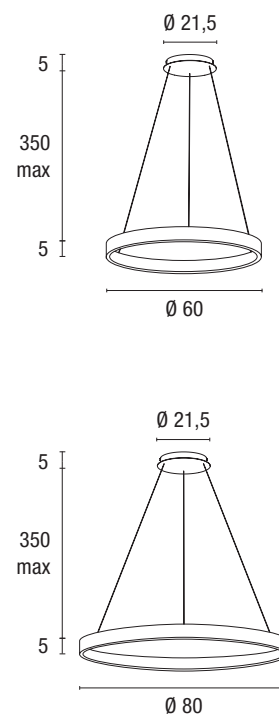

Optical Info p. 535

Description	Colour	Power	Source	Lumen Output	CCT	Weight	Code
Ø 60_ On / Off	White	40 W	SMD LED	2650 lm	3000K	3,0 kg	GRF16111
	Black	40 W	SMD LED	2650 lm	3000K	3,0 kg	GRF16112
Ø 80_ On / Off	White	60 W	SMD LED	3100 lm	3000K	4,0 kg	GRF16113
	Black	60 W	SMD LED	3100 lm	3000K	4,0 kg	GRF16114
Ø 60_ DALI / 1...10 V / Push	White	40 W	SMD LED	2650 lm	3000K	3,0 kg	GRF16111DM
	Black	40 W	SMD LED	2650 lm	3000K	3,0 kg	GRF16112DM
Ø 80_ DALI / 1...10 V / Push	White	60 W	SMD LED	3100 lm	3000K	4,0 kg	GRF16113DM
	Black	60 W	SMD LED	3100 lm	3000K	4,0 kg	GRF16114DM

 220÷240Vac | IP20

Versioni dimmerabili: regolazione della luminosità 0/1 - 100 % - Dimmable versions: light regulation 0/1 - 100 %

Finishes

White

Black



HOOP



Hoop è una sospensione realizzata in alluminio verniciato bianco opaco ed equipaggiata con schermo diffondente in PMMA. Si installa a sospensione mediante tre cavi in acciaio rivestiti con guaina trasparente e regolabili in altezza grazie ai tre “grip locks” posizionati sul corpo dell’apparecchio. Grazie a Hoop si ottengono effetti di luce morbida e diffusa adatti ad illuminare gli ambienti in modo confortevole e senza ombre dure. Il driver incluso può essere On/Off o dimmerabile multifunzione con controllo 1...10V, Push, DALI, ed alimenta una sorgente LED SMD ad alta efficienza. Hoop è disponibile nella versione a sospensione in diverse misure e potenze, e si completa con le analoghe versioni a plafone.

Hoop is a pendant made of matt white painted aluminium and equipped with a PMMA diffusing screen. It is suspended with three steel cables covered with transparent sheath and adjustable in height thanks to the three “grip locks” positioned on the body of the appliance. Thanks to Hoop, soft and diffused light effects are obtained, suitable for illuminating indoor ambients comfortably and without harsh shadows. The driver included can be On/Off or dimmable multifunction 1... 10V, Push, DALI controlled, and feeds a high efficiency SMD LED source. Hoop is available in the pendant version in different sizes and powers and is completed with the similar ceiling versions.



p.252

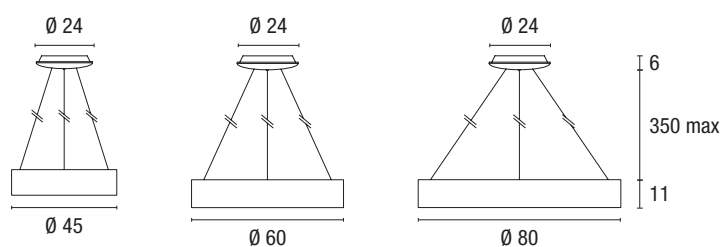

Optical Info p. 535

Description	Colour	Power	Source	Lumen Output	CCT	Weight	Code
Ø 45_ On / Off	White	32 W	SMD LED	1920 lm	3000K	1,6 kg	SOS00113
Ø 60_ On / Off	White	42 W	SMD LED	2520 lm	3000K	2,3 kg	SOS00116
Ø 80_ On / Off	White	62 W	SMD LED	3720 lm	3000K	3,0 kg	SOS00119
Ø 45_ DALI / 1...10 V / Push	White	32 W	SMD LED	1920 lm	3000K	1,6 kg	SOS00113DA
Ø 60_ DALI / 1...10 V / Push	White	42 W	SMD LED	2520 lm	3000K	2,3 kg	SOS00116DA
Ø 80_ DALI / 1...10 V / Push	White	62 W	SMD LED	3720 lm	3000K	3,0 kg	SOS00119DA

 220÷240Vac I IP20

Versioni dimmerabili: regolazione della luminosità 0/1 - 100 % - Dimmable versions: light regulation 0/1 - 100 %

Finishes

White



CORONA



p.253



Corona è realizzata in alluminio verniciato bianco opaco ed è dotata di schermo diffondente in PMMA per effetti di luce morbida e diffusa. La curvatura del corpo in alluminio si abbina perfettamente alla curvatura dello schermo interno in PMMA e realizza un'unica forma dal design morbido e contemporaneo. Corona si installa a sospensione mediante tre cavi in acciaio rivestiti con guaina trasparente e regolabili in altezza grazie ai tre "grip locks" posizionati sul corpo dell'apparecchio. La sorgente SMD LED ad alta efficienza è alimentata dal driver integrato nell'apparecchio e può essere On/Off o dimmerabile multifunzione con controllo 1...10V, Push, DALI. Corona è disponibile in diverse misure e potenze e si abbina alle versioni per l'installazione a plafone.

Corona is made of matt white painted aluminium and is equipped with a diffusing screen in PMMA for soft and diffused light effects. The curvature of the aluminium body perfectly matches the curvature of the internal PMMA screen and creates a unique shape with a soft and contemporary design. Corona is installed in suspension by means of three steel cables covered with transparent sheath and adjustable in height thanks to the three "grip locks" positioned on the body of the appliance. The high efficiency SMD LED source is powered by the driver integrated in the fixture and can be On/Off or dimmable multifunction with 1... 10V, Push, DALI control. Corona is available in different sizes and powers and is combined with versions for ceiling installation.

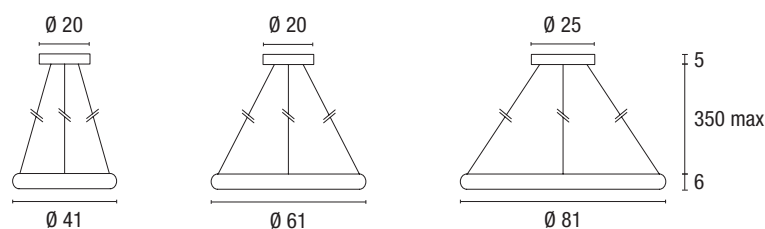

Optical Info p. 536

Description	Colour	Power	Source	Lumen Output	CCT	Weight	Code
Ø 41 On / Off	White	32 W	SMD LED	1920 lm	3000K	2,0 kg	GRF07111
Ø 61		50 W	SMD LED	3000 lm	3000K	3,3 kg	GRF07211
Ø 81		80 W	SMD LED	4800 lm	3000K	4,7 kg	GRF07311
Ø 41 DALI / 1...10 V / Push	White	32 W	SMD LED	1920 lm	3000K	2,0 kg	GRF07111DM
Ø 61		50 W	SMD LED	3000 lm	3000K	3,3 kg	GRF07211DM
Ø 81		80 W	SMD LED	4800 lm	3000K	4,7 kg	GRF07311DM

220÷240Vac I IP20

Versioni dimmerabili: regolazione della luminosità 0/1 - 100 % - Dimmable versions: light regulation 0/1 - 100 %

Finishes

White



BIKE



Bike è realizzata in alluminio verniciato bianco opaco ed è completa di schermo inferiore in PMMA; si installa sospensione mediante tre cavi in acciaio rivestiti con guaina trasparente e regolabili in altezza grazie ai tre “grip locks” posizionati sul corpo dell’apparecchio. Bike permette di realizzare effetti di luce morbida e diffusa verso il basso ed è particolarmente indicata per l’illuminazione generale di ambienti di medie o grandi dimensioni. La sorgente SMD LED ad alta efficienza è alimentata dal driver integrato nell’apparecchio che può essere On/Off o dimmerabile multifunzione con controllo 1...10V, Push, DALI. Bike è disponibile in diverse misure e potenze e si abbina alle corrispondenti versioni per il montaggio a plafone.



p.257

Bike is made of matt white painted aluminium and is complete with lower PMMA screen; the pendant version is installed by means of three steel cables covered with transparent sheath and adjustable in height thanks to the three “grip locks” positioned on the body of the appliance. Bike allows you to create soft and diffused down light effects and is particularly suitable for general lighting of medium or large indoor ambients. The high efficiency SMD LED source is powered by the driver integrated in the fixture which can be On/Off or dimmable multifunction 1... 10V, Push, DALI controlled. Bike is available in different sizes and powers and can be combined with the corresponding versions for ceiling mounting.

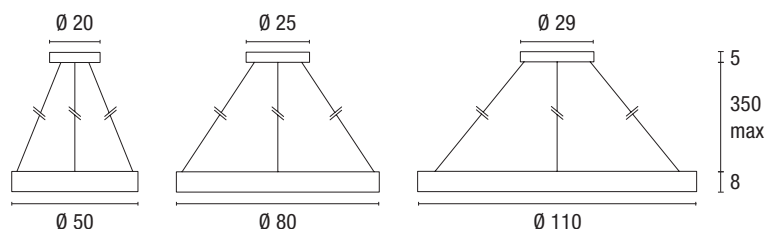

Optical Info p. 536

Description	Colour	Power	Source	Lumen Output	CCT	Weight	Code
Ø 50 On / Off	White	38 W	SMD LED	2280 lm	3000K	3,5 kg	GRF09111
Ø 80		80 W	SMD LED	4800 lm	3000K	6,4 kg	GRF09211
Ø 110		120 W	SMD LED	7200 lm	3000K	11,7 kg	GRF09311
Ø 50 Dimmerabile DALI / 1...10V / Push	White	38 W	SMD LED	2280 lm	3000K	3,5 kg	GRF09111DM
Ø 80		80 W	SMD LED	4800 lm	3000K	6,4 kg	GRF09211DM
Ø 110		120 W	SMD LED	7200 lm	3000K	11,7 kg	GRF09311DM

 220÷240Vac I IP20

Versioni dimmerabili: regolazione della luminosità 0/1 - 100 % - Dimmable versions: light regulation 0/1 - 100 %

Finishes

White



PENNY

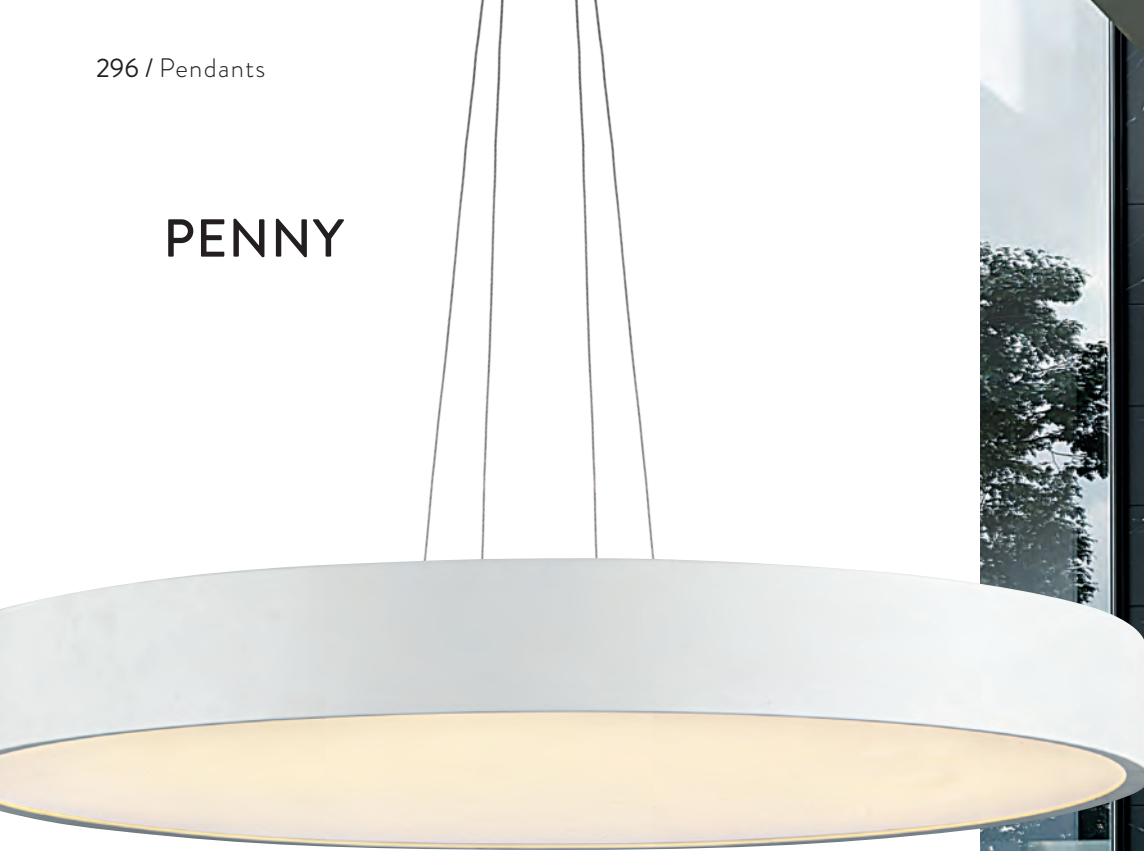

Penny è realizzata in alluminio verniciato bianco opaco e si caratterizza per il suo grande schermo inferiore in PMMA che si illumina in modo perfettamente uniforme; Penny si installa a sospensione grazie a quattro cavi in acciaio rivestito in PVC regolabili in altezza mediante quattro “grip locks” montati sul rosone. Utilizzando Penny si ottengono effetti di luce morbida e diffusa verso il basso con emissioni oltre 12000 lumen nella versione di maggior diametro; Penny è quindi particolarmente indicata per illuminare grandi ambienti con luce uniforme, perfettamente distribuita e senza ombre dure. Equipaggiata con sorgenti SMD LED ad alta efficienza, Penny è completa di driver integrati nel corpo dell'apparecchio ed è disponibile con controllo On/Off o dimmerabile multifunzione 1...10V, Push, DALI. Penny è disponibile in diverse misure e potenze si abbina alle corrispondenti versioni per l'installazione a soffitto.

Penny is made of matt white painted aluminium and is characterized by its large PMMA lower screen which lights up perfectly evenly; Penny is suspended by means of four PVC-coated steel cables adjustable in height by means of four “grip locks” mounted on the canopy. By using Penny, soft and diffused downward light effects are obtained with emissions beyond 12000 lumens in the larger diameter version; Penny is therefore particularly suitable for illuminating large rooms with uniform light, perfectly distributed and without harsh shadows. Equipped with high efficiency SMD LED sources, Penny is complete with drivers integrated in the body of the fixture and is available with On/Off control or dimmable multifunction 1...10 V, Push, DALI. Penny is available in different sizes and powers and is combined with the corresponding versions for ceiling mounting.



p.254

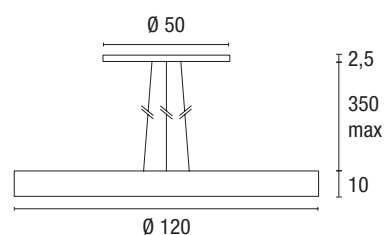
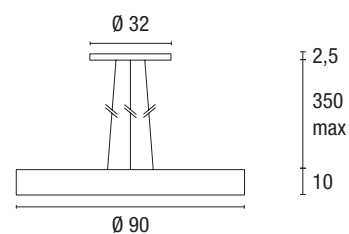
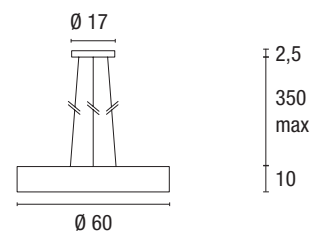

Optical Info p. 536

Description	Colour	Power	Source	Lumen Output	CCT	Weight	Code
Ø 60 On / Off	White	60 W	SMD LED	3900 lm	3000K	4,4 kg	GRF10111
Ø 90		120 W	SMD LED	7800 lm	3000K	11,3 kg	GRF10211
Ø 120		195 W	SMD LED	12675 lm	3000K	21,1 kg	GRF10311
Ø 60 Dimmerabile DALI / 1...10 V / Push	White	60 W	SMD LED	3900 lm	3000K	4,4 kg	GRF10111DM
Ø 90		120 W	SMD LED	7800 lm	3000K	11,3 kg	GRF10211DM
Ø 120		195 W	SMD LED	12675 lm	3000K	21,1 kg	GRF10311DM

 220÷240Vac I IP20

Versioni dimmerabili: regolazione della luminosità 0/1 - 100 % - Dimmable versions: light regulation 0/1 - 100 %

Finishes

White





KART



p.256



Kart è realizzata in alluminio verniciato bianco opaco ed è dotata di schermo diffondente in PMMA che permette di ottenere effetti di luce morbida e diffusa. La curvatura del corpo in alluminio si abbina perfettamente alla curvatura dello schermo interno in PMMA per realizzare un'unica forma dal design morbido e contemporaneo. Kart si installa a sospensione mediante quattro cavi in acciaio rivestiti con guaina trasparente e regolabili in altezza grazie ai quattro "grip locks" posizionati sul corpo dell'apparecchio. La sorgente SMD LED ad alta efficienza è alimentata dal driver integrato nell'apparecchio e può essere On/Off o dimmerabile multifunzione con controllo 1...10V, Push, DALI. Kart è disponibile in diverse misure e potenze e si abbina alle versioni per installazione a soffitto.

Kart is made of matt white painted aluminium and is equipped with a PMMA diffusing screen which allows to obtain soft and diffused light effects. The curvature of the aluminium body perfectly matches the curvature of the internal PMMA screen to create a single shape with a soft and contemporary design. Kart is installed in suspension by means of four steel cables covered with transparent sheath and adjustable in height thanks to the four "grip locks" positioned on the body of the appliance. The high efficiency SMD LED source is powered by the driver integrated in the fixture and can be On / Off or dimmable multifunction with 1...10V, Push, DALI control. Kart is available in different sizes and powers and matches the versions for ceiling installation.

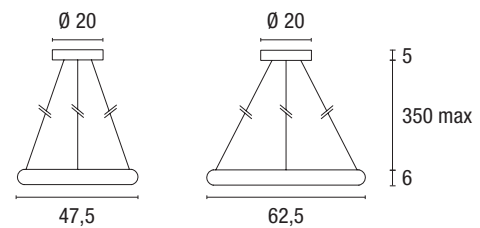

Optical Info p. 536

Description	Colour	Power	Source	Lumen Output	CCT	Weight	Code
47,5 x 47,5 mm On / Off	White	38 W	SMD LED	2280 lm	3000K	2,6 kg	GRF08111
62,5 x 62,5 mm		50 W	SMD LED	3000 lm	3000K	2,9 kg	GRF08211
47,5 x 47,5 mm DALI / 1...10 V / Push	White	38 W	SMD LED	2280 lm	3000K	2,6 kg	GRF08111DM
62,5 x 62,5 mm		50 W	SMD LED	3000 lm	3000K	2,9 kg	GRF08211DM

220÷240Vac I IP20

Versioni dimmerabili: regolazione della luminosità 0/1 - 100 % - Dimmable versions: light regulation 0/1 - 100 %

Finishes

White



INFINITY

I movimenti incrociati della struttura caratterizzano il modello INFINITY. L'apparente semplicità formale diventa elemento di spicco in ogni installazione. Il corpo lampada è realizzato in alluminio estruso. Lo schermo in policarbonato ha uno speciale trattamento per favorire l'emissione luminosa. Struttura disponibile in colore bianco opaco o finitura oro. L'apparecchio è regolabile in altezza. Il driver, ad alta efficienza, è integrato nel rosone a soffitto. Sono disponibili versioni dimmerabili multifunzione con controllo 1...10V, Push, DALI.

The crossed movements of the structure characterize the INFINITY models. An apparent formal simplicity becomes a prominent element in every installation. The lamp body is made of extruded aluminum, a polycarbonate screen with a special treatment maximizes light emission. Structure available in matt white or gold finish. The device is adjustable in height. The high efficiency driver is integrated in the ceiling rose. Multifunction dimmable versions with 1... 10V, Push, DALI.



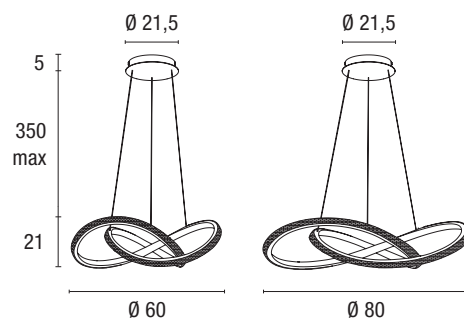

Description	Colour	Power	Source	Lumen Output	CCT	Weight	Code
Ø 60_ On / Off	White	50 W	SMD LED	3600 lm	3000K	3,3 kg	GRF17111
	Brushed gold	50 W	SMD LED	3600 lm	3000K	3,3 kg	GRF17112
Ø 80_ On / Off	White	80 W	SMD LED	5570 lm	3000K	4,3 kg	GRF17113
	Brushed gold	80 W	SMD LED	5570 lm	3000K	4,3 kg	GRF17114
Ø 60_ DALI	White	50 W	SMD LED	3600 lm	3000K	3,3 kg	GRF17111DM
	Brushed gold	50 W	SMD LED	3600 lm	3000K	3,3 kg	GRF17112DM
Ø 80_ DALI	White	80 W	SMD LED	5570 lm	3000K	4,3 kg	GRF17113DM
	Brushed gold	80 W	SMD LED	5570 lm	3000K	4,3 kg	GRF17114DM

220÷240Vac | IP20

Versioni dimmerabili: regolazione della luminosità 0/1 - 100 % - Dimmable versions: light regulation 0/1 - 100 %

Finishes

White

Brushed gold



LUNAR



p.410



Apparecchio a sospensione. Corpo in alluminio verniciato bianco opaco. Schermo diffondente in PMMA. Sorgente LED ad alta efficienza. Per effetti di luce diffusa. Driver elettronico integrato nell'apparecchio. Diffusore orientabile. Eventuali altre alimentazioni disponibili su richiesta salvo fattibilità. Cavo di sospensione in PVC di colore bianco. Lunghezza massima 250 cm.

Pendant luminaire. Matt white painted aluminium body. PMMA diffusing screen. High efficiency LED light source. For diffused light effects. Electronic driver integrated in the fixture. Adjustable diffuser. Other powers available upon request and after checking feasibility. White PVC suspension cable. Maximum length 250 cm.



Optical Info p. 536

Description	Colour	Power	Source	Lumen Output	CCT	Weight	Code
Ø 39	White	20 W	SMD LED	1910 lm	3000K	2,7 kg	SOS00056
<input type="checkbox"/> 220÷240Vac I IP20 Flusso luminoso emesso: semi-diretto; frontale 90% retro 10% / Luminous flux output: semi-direct; front 90% back 10%							

Finishes

White



CROSS



La sospensione Cross è realizzata con doppio corpo in alluminio verniciato bianco. Lo schermo diffondente è in PMMA. Viene utilizzata una sorgente LED ad alta efficienza che garantisce un'ottima resa per intensità e qualità. L'alimentazione è collocata nel rosone a soffitto ed utilizza un driver elettronico integrato. Gli anelli luminosi si regolano in modo indipendente in altezza ed inclinazione. Possibilità di gestire sistemi di dimmerazione su richiesta. Il cavo di sospensione in acciaio è rivestito con guaina trasparente ed è regolabile in altezza con sistema autobloccante "grip lock". Lunghezza massima 350 cm.

The Cross suspension is made with double body in white painted extruded aluminum. PMMA diffuser screen. An high efficiency LED source guarantees an excellent yield in intensity and quality. The power supply is located in the ceiling canopy and uses an integrated electronic driver. Light rings are independently adjustable in height and inclination. Possibility to manage dimming systems on request. Steel suspension cable is covered with transparent sleeve, adjustable in height with self-locking system "grip lock". Maximum length 350 cm.



Pendant Ø 40 / 60 cm.

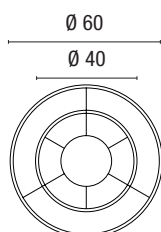

Pendant Ø 60 / 80 cm.

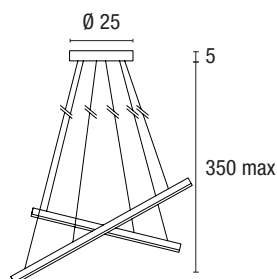
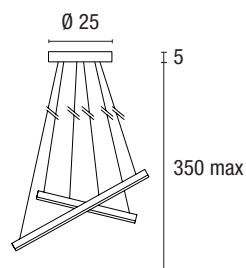
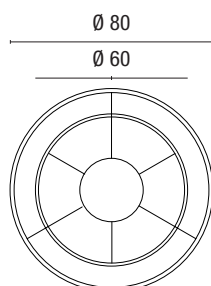

Optical Info p. 536

Description	Colour	Power	Source	Lumen Output	CCT	Weight	Code
Ø 40 / 60	White	74 W	SMD LED	5088 lm	3000K	3,5 kg	GRF13111
Ø 60 / 80	White	104 W	SMD LED	7630 lm	3000K	5,2 kg	GRF13211

☐ 220÷240Vac I IP20

Finishes

White



STEK



p.367



Stek è un apparecchio a sospensione disponibile in due diverse misure: il corpo, in alluminio verniciato bianco opaco o nero opaco, può essere lungo 60 o 80 cm. Lo schermo diffondente e il cut-off nero permettono una perfetta schermatura della sorgente led integrata, evitando l'abbagliamento diretto da tutte le direzioni di osservazione. Stek è l'apparecchio ideale per effetti di luce spot estremamente definiti. Equipaggiato con driver elettronico integrato nell'apparecchio, è completo di cavo di sospensione in PVC trasparente, lunghezza massima 350 cm.

Stek is a pendant luminaire available in two different sizes: the body, in matt white or matt black painted aluminium, can be 60 or 80 cm long. The diffusing screen and the black cut-off allow perfect shielding of the integrated LED source, avoiding direct glare from all directions of observation. Stek is the ideal fixture for extremely defined spotlight effects. Equipped with an electronic driver integrated in the luminaire, it is complete with a transparent PVC suspension cable, maximum length 350 cm.

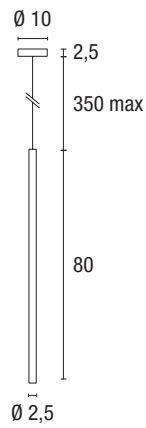
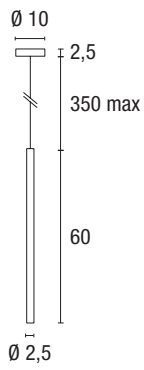

Optical Info p. 536

Description	Colour	Power	Source	Lumen Output	CCT	Weight	Code
h. 60 cm.	White	4,5 W	Power LED	410 lm	3000K	0,6 kg	SOS11111
	Black	4,5 W	Power LED	410 lm	3000K	0,6 kg	SOS11131
h. 80 cm.	White	4,5 W	Power LED	410 lm	3000K	0,7 kg	SOS11211
	Black	4,5 W	Power LED	410 lm	3000K	0,7 kg	SOS11231

220÷240Vac | IP20

Finishes

White

Black



LUPIN

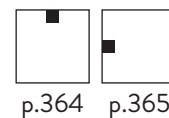

La serie di apparecchi Lupin è realizzata in alluminio verniciato bianco opaco. Attacco lampada GU10. Lupin è progettato per illuminare con effetti di luce concentrata e si completa con le versioni in coordinato per l'installazione a parete. Cavo di sospensione in FEP+PVC trasparente, lunghezza massima 185 cm.

The Lupin luminaire series is made in aluminium matt white painted. GU10 socket. Lupin is designed to illuminate with focusing light effects and is completed with coordinated versions for wall installation. Suspension cable in FEP + transparent PVC, maximum length 185 cm.



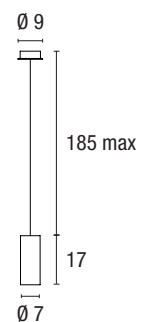

Description	Colour	Power	Source	Socket	Lumen Output	CCT	Weight	Code
h. 17 cm.	White	7 W	LED	GU10	550 lm	3000K	0,6 kg	SOS063
 220÷240Vac IP20							Lamp included	

Finishes

White

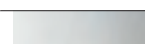

GIOVE

Giove è un apparecchio a sospensione caratterizzato dal paralume in tessuto montato su telaio. È completo di schermo in pergamena traslucida ed è equipaggiato con attacchi E27. Permette di ottenere effetti di luce diffusa ed è disponibile in diversi diametri. Si sospende fino a 350 cm. grazie a tre cavi in acciaio rivestiti con guaina trasparente, regolabili in altezza con sistema autobloccante "grip lock". Cavo di alimentazione in FEP+PVC trasparente.

Giove is a pendant luminaire characterized by a fabric shade mounted on a frame. It is complete with a translucent parchment screen and is equipped with E27 sockets. It allows to obtain diffused light effects and is available in different diameters. It suspends up to 350 cm. thanks to three steel cables covered with transparent sheath, adjustable in height with self-locking "grip lock" system. Power cable in FEP + transparent PVC.



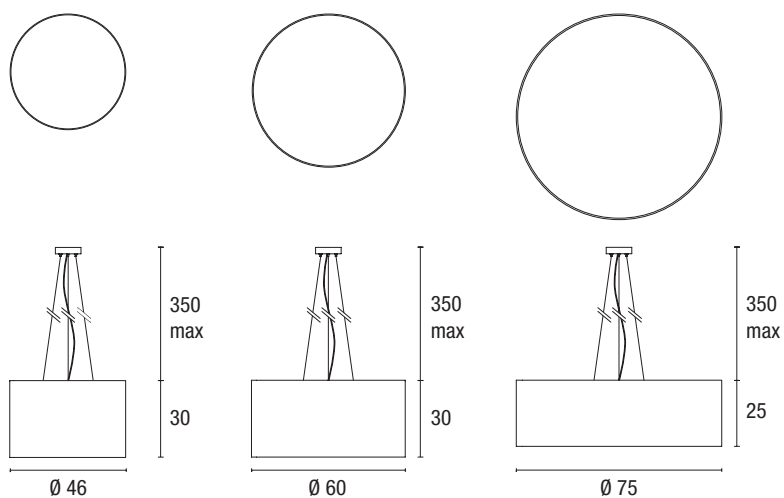

Description	Colour	Power	Source	Socket	CCT	Weight	Code
Ø 46	Linen	max 40 W	LED / IAA	E27	3000K	0,7 kg	GRF14101
	Bordeaux	max 40 W	LED / IAA	E27	3000K	0,7 kg	GRF14102
	Black Net	max 40 W	LED / IAA	E27	3000K	0,7 kg	GRF14103
Ø 60	Linen	max 40 W	LED / IAA	E27	3000K	1,2 kg	GRF14201
	Bordeaux	max 40 W	LED / IAA	E27	3000K	1,2 kg	GRF14202
	Black Net	max 40 W	LED / IAA	E27	3000K	1,2 kg	GRF14203
Ø 75	Linen	3x max 40 W	LED / IAA	E27	3000K	1,8 kg	GRF14301
	Bordeaux	3x max 40 W	LED / IAA	E27	3000K	1,8 kg	GRF14302
	Black Net	3x max 40 W	LED / IAA	E27	3000K	1,8 kg	GRF14303

⊕ 220-240Vac | IP20

Lamp not included

Lampshade finish

Linen

Bordeaux

Black Net



SATURNO



Saturno è un apparecchio a sospensione caratterizzato dal paralume in tessuto montato su telaio e dalla sua geometria ad anello. È completo di schermo in pergamena traslucida ed è equipaggiato con attacchi E27. Permette di ottenere effetti di luce diffusa ed è disponibile in diversi diametri. Saturno si installa a sospensione grazie ai cavetti in acciaio rivestito con guaina trasparente; l'altezza di sospensione è regolabile con sistema autobloccante "grip lock" fino ad una altezza massima di 350 cm. Cavo di alimentazione in FEP+PVC trasparente.

Saturno is a pendant luminaire characterized by a fabric shade mounted on a frame and by its ring shape. It is complete with a translucent parchment screen and is equipped with E27 sockets. It allows to obtain diffused light effects and is available in different diameters. Saturno can be installed as pendant up to 350 cm thanks to four steel cables covered with transparent sheath, adjustable in height with self-locking "grip lock" system. Power cable in FEP+PVC transparent.

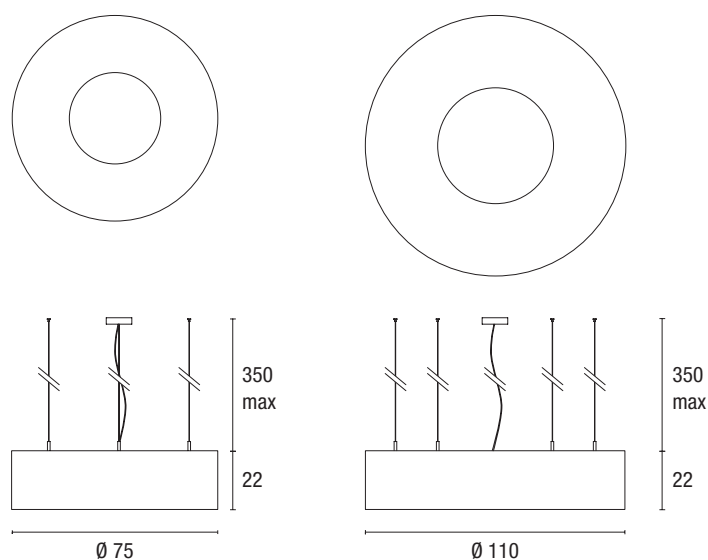

Description	Colour	Power	Source	Socket	CCT	Weight	Code
Ø 75	Linen	6x max 40 W	LED / IAA	E27	3000K	3,0 kg	GRF13101
	Bordeaux	6x max 40 W	LED / IAA	E27	3000K	3,0 kg	GRF13102
	Black Net	6x max 40 W	LED / IAA	E27	3000K	3,0 kg	GRF13103
Ø 110	Linen	8x max 40 W	LED / IAA	E27	3000K	4,5 kg	GRF13201
	Bordeaux	8x max 40 W	LED / IAA	E27	3000K	4,5 kg	GRF13202
	Black Net	8x max 40 W	LED / IAA	E27	3000K	4,5 kg	GRF13203

⊕ 220÷240Vac | IP20

Lamp not included

Lampshade finish

Linen

Bordeaux

Black Net



URANO_Pendants





p.264

Urano si installa a plafone o a sospensione; è composto da un pannello a led e da paralume in tessuto completo di schermo in pergamena traslucida. Permette di ottenere effetti di luce estremamente confortevoli grazie all'abbinamento del pannello di tipo "edge led" con la pergamena diffondente. Disponibile in diverse misure e potenze, si installa a sospensione grazie ai cavetti in acciaio rivestito con guaina trasparente; l'altezza di sospensione è regolabile con sistema autobloccante "grip lock" fino ad una altezza massima di 350 cm.; la versione a plafone è completa di staffe di fissaggio a soffitto. Cavo di alimentazione in FEP+PVC trasparente.

Urano is a ceiling mounting or pendant luminaire; it is composed of a LED panel and a fabric shade complete with a translucent parchment screen. It allows to obtain extremely comfortable lighting effects thanks to the combination of the "edge led" type panel with the diffusing parchment. Urano can be installed as pendant up to 350 cm thanks to four steel cables covered with transparent sheath, adjustable in height with self-locking "grip lock" system; the ceiling mounted version is complete with ceiling fixing brackets. Power cable in FEP + PVC transparent.

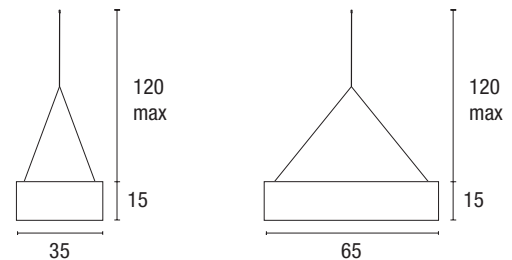

Description	Colour	Power	Source	Lumen Output	CCT	Weight	Code
35 x 35 cm	Bordeaux	18 W	LED Panel	1200 lm	3000K	2,8 kg	GRF15105
	Black Net	18 W	LED Panel	1100 lm	3000K	2,8 kg	GRF15106
65 x 65 cm	Bordeaux	36 W	LED Panel	2200 lm	3000K	3,8 kg	GRF15205
	Black Net	36 W	LED Panel	1950 lm	3000K	3,8 kg	GRF15206

⊕ 220÷240Vac | IP20

Lamp not included

Lampshade finish

Bordeaux

Black Net





WALL

06

I N D E X

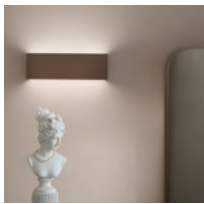

Quik_p.318

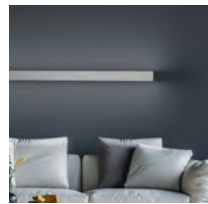

Karma_p.326



Maya_p.332



Maya Mini_p.340



Match_p.344

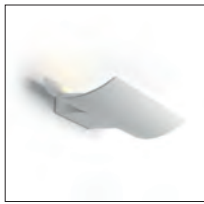

Onda_p.345



Elle_p.346

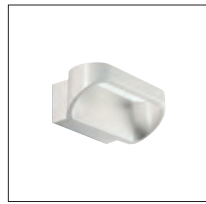

Grace_p.347

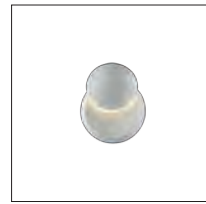

Eclis_p.348



Polka_p.350

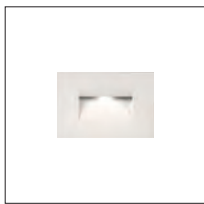

Fast_p.352



Alyson_p.356

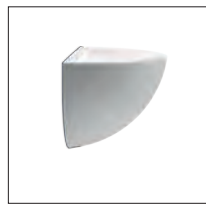

Pod_p.358



Boreale_p.359



Idra_p.360



Tube_p.361



Oberon_p.362

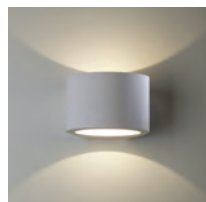

Ely_p.363



Lupin_p.364



Dippy_p.366



Pako_p.367



Berlin_p.368



London_p.369



Paris_p.370



Cama_p.371



Soft_p.370



Jazz_p.371

QUIK

Il progetto Quik aggiunge valore nelle installazioni di lampade a parete. La flessibilità ed il livello tecnico-qualitativo delle soluzioni adottate rende Quik elemento centrale in queste applicazioni. Disponibile come singolo apparecchio in infinite misure, si può installare anche in linea continua oppure con sistemi angolari. La gamma include versioni On-Off, DALI, Push, Casambi; Accensione singola oppure doppia accensione. Grande attenzione è stata posta ai rapporti dimensionali ed estetici. Il copro lampada è realizzato in alluminio estruso e verniciato, si caratterizza per lo stile minimale ma decisamente personale e definito. La cura costruttiva ed i diversi colori disponibili rendono Quik adatto ad ogni contesto in cui si debba prevedere un apparecchio con alti contenuti tecnologici in grado di offrire prestazioni di vertice.

The Quik project adds value to wall lamp installations. The flexibility and the technical-qualitative level of the solutions adopted makes Quik a central element in these applications. Available as a single luminaire in several sizes, it can also be installed in continuous line or with angular systems. The range includes versions On-Off, DALI, Push, Casambi; Single or double switch. The focus is set on dimensional and aesthetic relations. The lamp cover is made of extruded and painted aluminum, is characterized by minimal style but definitely personal and defined. The perfect construction and the colors available make Quik suitable for any context in which you have to provide a luminaire with high technological content with top performance.





MODEL

300

600

900

1100

1700

2200

QUIK





QUIK_Line

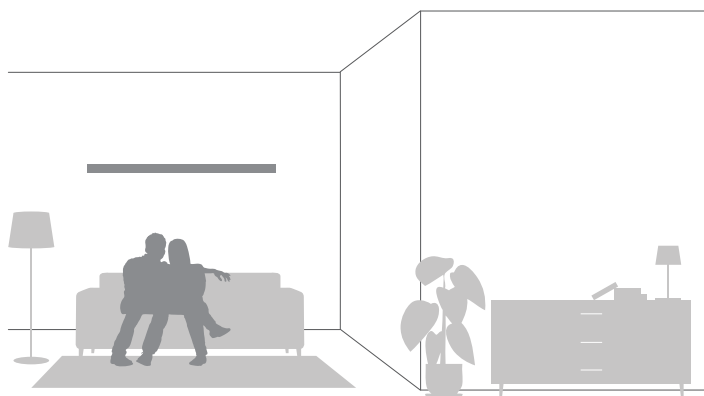
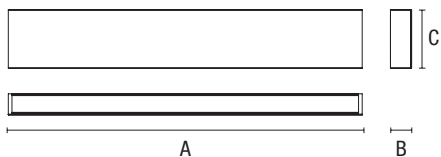

Uplight_Downlight

single switch

Model	Power	Lumen output		Product dimension			* code to complete
		downlight	uplight	A	B	C	
300	6+6 W	645 lm	645 lm	303 mm	35 mm	95 mm	QM-WABATA ■ ▲ ● □
600	12+12 W	1290 lm	1290 lm	582 mm	35 mm	95 mm	QM-WABAAC ■ ▲ ● □
900	18+18 W	1935 lm	1935 lm	862 mm	35 mm	95 mm	QM-WABAUD ■ ▲ ● □
1100	24+24 W	2580 lm	2580 lm	1141 mm	35 mm	95 mm	QM-WABABE ■ ▲ ● □
1700	36+36 W	3870 lm	3870 lm	1700 mm	35 mm	95 mm	QM-WABACG ■ ▲ ● □
2200	48+48 W	5160 lm	5160 lm	2259 mm	35 mm	95 mm	QM-WABADJ ■ ▲ ● □

dual switch

1100	24+24 W	2580 lm	2580 lm	1141 mm	35 mm	95 mm	QM-WACABE ■ ▲ ● □
1700	36+36 W	3870 lm	3870 lm	1700 mm	35 mm	95 mm	QM-WACACG ■ ▲ ● □
2200	48+48 W	5160 lm	5160 lm	2259 mm	35 mm	95 mm	QM-WACADJ ■ ▲ ● □

⊕ 220÷240Vac | IP40

UP to 108 lm/W | L80/B20 80.000 h. | CRI>90 | UP to R90 | SDCM<3
Lumen output values: luminaire luminous flux at 4000 K - matt clear

Optical Info p. 532

* Select your option

CCT	■	Optic	▲	Colour	●	Control #	□
2700 K	1	Matt opal	E	White	W	On/Off	NF
3000 K	2	Matt clear	R	Black	B	DALI	DA
4000 K	3			Silver	G	Casambi	CA
Tunable **	4			Corten	C	Push	PU
				Tobacco	O		

No 300, 600 mm - Casambi

** Only: 1100, 1700, 2200 mm
DALI, Casambi.

Quik offre grandi possibilità di customizzare secondo specifiche richieste se non previste dai modelli standard. custom@panint.it
Quik offers a large possibilities to customize according to specific request as sizes, colors, long lines. custom@panint.it

Finishes

White Black Silver Corten Tobacco

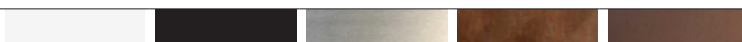

QUIK_Inside Corner



Uplight_Downlight

single switch	Model	Lumen output		Product dimension			* code to complete	
		downlight	uplight	A	B	C		
1	600	12+12 W	1290 lm	1290 lm	582 mm	35 mm	95 mm	QM-WABDAC ■ △ ● □
	900	18+18 W	1935 lm	1935 lm	862 mm	35 mm	95 mm	QM-WABDUD ■ △ ● □
	1100	24+24 W	2580 lm	2580 lm	1141 mm	35 mm	95 mm	QM-WABDBE ■ △ ● □
	1700	36+36 W	3870 lm	3870 lm	1700 mm	35 mm	95 mm	QM-WABDCG ■ △ ● □
	2200	48+48 W	5160 lm	5160 lm	2259 mm	35 mm	95 mm	QM-WABDDJ ■ △ ● □
2	600	12+12 W	1290 lm	1290 lm	582 mm	35 mm	95 mm	QM-WABEAC ■ △ ● □
	900	18+18 W	1935 lm	1935 lm	862 mm	35 mm	95 mm	QM-WABEUD ■ △ ● □
	1100	24+24 W	2580 lm	2580 lm	1141 mm	35 mm	95 mm	QM-WABEBE ■ △ ● □
	1700	36+36 W	3870 lm	3870 lm	1700 mm	35 mm	95 mm	QM-WABECG ■ △ ● □
	2200	48+48 W	5160 lm	5160 lm	2259 mm	35 mm	95 mm	QM-WABEDJ ■ △ ● □
dual switch	1100	24+24 W	2580 lm	2580 lm	1141 mm	35 mm	95 mm	QM-WACDBE ■ △ ● □
	1700	36+36 W	3870 lm	3870 lm	1700 mm	35 mm	95 mm	QM-WACDCG ■ △ ● □
	2200	48+48 W	5160 lm	5160 lm	2259 mm	35 mm	95 mm	QM-WACDDJ ■ △ ● □
	1100	24+24 W	2580 lm	2580 lm	1141 mm	35 mm	95 mm	QM-WACEBE ■ △ ● □
	1700	36+36 W	3870 lm	3870 lm	1700 mm	35 mm	95 mm	QM-WACECG ■ △ ● □
	2200	48+48 W	5160 lm	5160 lm	2259 mm	35 mm	95 mm	QM-WACEDJ ■ △ ● □

⊕ 220÷240Vac | IP40

UP to 108 lm/W | L80/B20 80.000 h. | CRI>90 | UP to RGO | SDCM<3
Lumen output values: luminaire luminous flux at 4000 K - matt clear

Optical Info p. 532

* Select your option

CCT	■	Optic	△	Colour	●	Control #	□
2700 K	1	Matt opal	E	White	W	On/Off	NF
3000 K	2	Matt clear	R	Black	B	DALI	DA
4000 K	3			Silver	G	Casambi	CA
Tunable **	4			Corten	C	Push	PU
				Tobacco	O		

No 600 mm - Casambi

** Only: 1100, 1700, 2200 mm
DALI, Casambi.

Quik offre grandi possibilità di customizzare secondo specifiche richieste se non previste dai modelli standard. custom@panint.it
Quik offers a large possibilities to customize according to specific request as sizes, colors, long lines. custom@panint.it

Finishes

White Black Silver Corten Tobacco

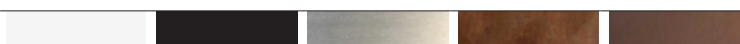

QUIK_Outside Corner



Uplight_Downlight

single switch	Model	Power	Lumen output		Product dimension			* code to complete
			downlight	uplight	A	B	C	
1	600	12+12 W	1290 lm	1290 lm	582 mm	35 mm	95 mm	QM-WABBAC ■ △ ● □
	900	18+18 W	1935 lm	1935 lm	862 mm	35 mm	95 mm	QM-WABBUD ■ △ ● □
	1100	24+24 W	2580 lm	2580 lm	1141 mm	35 mm	95 mm	QM-WABBBE ■ △ ● □
	1700	36+36 W	3870 lm	3870 lm	1700 mm	35 mm	95 mm	QM-WABBGG ■ △ ● □
	2200	48+48 W	5160 lm	5160 lm	2259 mm	35 mm	95 mm	QM-WABBDJ ■ △ ● □
2	600	12+12 W	1290 lm	1290 lm	582 mm	35 mm	95 mm	QM-WABCAC ■ △ ● □
	900	18+18 W	1935 lm	1935 lm	862 mm	35 mm	95 mm	QM-WABCUD ■ △ ● □
	1100	24+24 W	2580 lm	2580 lm	1141 mm	35 mm	95 mm	QM-WABCBE ■ △ ● □
	1700	36+36 W	3870 lm	3870 lm	1700 mm	35 mm	95 mm	QM-WABCCG ■ △ ● □
	2200	48+48 W	5160 lm	5160 lm	2259 mm	35 mm	95 mm	QM-WABCDJ ■ △ ● □

dual switch	Model	Power	Lumen output	Product dimension	* code to complete		
						A	B
1	1100	24+24 W	2580 lm	1141 mm	35 mm	95 mm	QM-WACBBE ■ △ ● □
	1700	36+36 W	3870 lm	1700 mm	35 mm	95 mm	QM-WACBCG ■ △ ● □
	2200	48+48 W	5160 lm	2259 mm	35 mm	95 mm	QM-WACBDJ ■ △ ● □
2	1100	24+24 W	2580 lm	1141 mm	35 mm	95 mm	QM-WACCBE ■ △ ● □
	1700	36+36 W	3870 lm	1700 mm	35 mm	95 mm	QM-WACCCG ■ △ ● □
	2200	48+48 W	5160 lm	2259 mm	35 mm	95 mm	QM-WACCDJ ■ △ ● □

⊕ 220÷240Vac | IP40

UP to 108 lm/W | L80/B20 80.000 h. | CRI>90 | UP to R90 | SDCM<3
Lumen output values: luminaire luminous flux at 4000 K - matt clear

Optical Info p. 532

* Select your option

CCT	■	Optic	△	Colour	●	Control #	□	# No 600 mm - Casambi
2700 K	1	Matt opal	E	White	W	On/Off	NF	** Only: 1100, 1700, 2200 mm DALI, Casambi.
3000 K	2	Matt clear	R	Black	B	DALI	DA	
4000 K	3			Silver	G	Casambi	CA	
Tunable **	4			Corten	C	Push	PU	
				Tobacco	O			

Quik offre grandi possibilità di customizzare secondo specifiche richieste se non previste dai modelli standard. custom@panint.it
Quik offers a large possibilities to customize according to specific request as sizes, colors, long lines. custom@panint.it

Finishes

White Black Silver Corten Tobacco

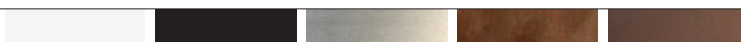



KARMA_Wall

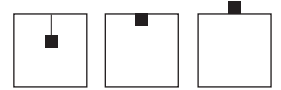

Karma è un sistema d'illuminazione che si pone ai vertici della categoria per qualità, efficienza ed estetica. La validità dei contenuti permette il passaggio dalla forma lineare alle composizioni, coniugando la tecnologia più avanzata ad un quadro stilistico contemporaneo e di facile interpretazione. La versione parete offre elevate prestazioni ed affidabilità. Karma è disponibile in diverse misure, colori e gestioni elettroniche che prevedono ON-OFF, DALI, Push, Casambi. Un configuratore on line permette la selezione del prodotto desiderato in maniera rapida e semplice.

Karma is a lighting system that stands at the top of the category for quality, efficiency and aesthetics. The validity of the contents allows the transition from linear form to compositions, combining the most advanced technology with a contemporary and easy to interpret stylistic framework. The wall version offers high performance and reliability. Karma is available in different sizes, colors and electronic management that include ON-OFF, DALI, Push, Casambi. An online configurator allows quick and easy selection of the desired product.



+ KARMA Recessed pag 056



+ KARMA Ceiling pag 220



+ KARMA Pendant pag 268

EXTENDED COLLECTION

Karma_Wall

Installation

Karma si installa in fila continua grazie al particolare giunto meccanico che, grazie alle sue viti di regolazione, permette di allineare perfettamente i singoli moduli strutturali. Agendo sulle viti di regolazione dei giunti meccanici si allineano i moduli strutturali fra loro, ottenendo così una migliore installazione. Gli appositi fast-plug garantiscono la connessione elettrica fra i moduli strutturali precablati senza bisogno di utilizzare utensili.

Karma can be installed in a continuous line thanks to the mechanic joint that, thanks to its adjustment screws, allows the individual rail modules to be perfectly aligned. Acting on the adjustment screws of the mechanical joints and aligning the rail modules together, thus obtaining a better installation. The special fast-plugs require the electrical connection between pre-wired modules without tools.

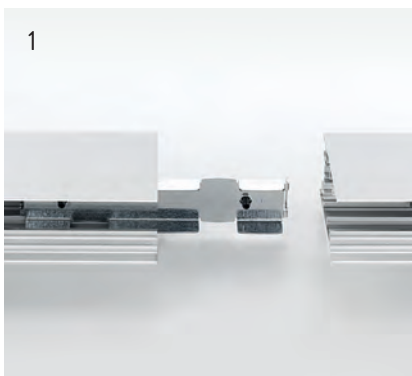

- 1 - Inserimento del giunto meccanico fra i moduli strutturali
Inserting mechanical joint between the rail modules
- 2 - Accoppiamento dei moduli strutturali
Matching of rail modules
- 3 - Fissaggio e allineamento dei moduli strutturali grazie alle apposite viti di regolazione
Fixing and alignment of the rail modules thanks to the appropriate adjustment screws

L'installazione di Karma è rapida, semplice ed intuitiva; una volta fissati a soffitto i moduli strutturali già precablati, si montano i moduli ottici con un semplice click grazie al sistema di fissaggio magnetico incorporato. Il collegamento elettrico dei moduli ottici è in bassissima tensione e avviene senza utensili grazie all'apposito "fast plug". Il sistema di regolazione della lunghezza del cavo di sospensione è facilmente accessibile perché collocato direttamente sul modulo strutturale.

The installation of Karma is quick, simple and intuitive; once the pre-wired rail modules are fixed to the wall, the optical modules are mounted with a simple click thanks to the built-in magnetic fixing system. The electrical connection of the optical modules is in very low voltage and without tools thanks to the special "fast plug". The suspension cable length adjustment system is easily accessible because it is placed directly on the rail module.



KARMA_Wall

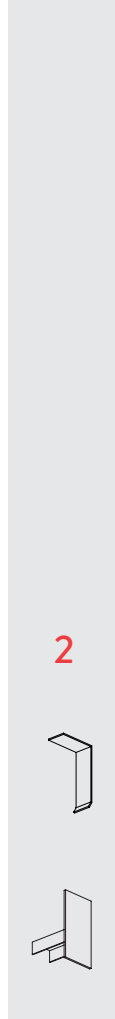
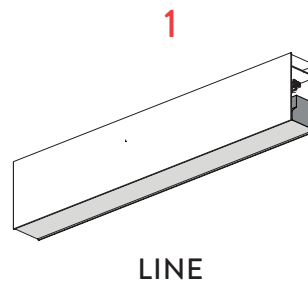
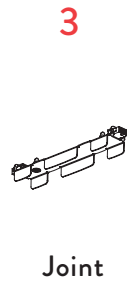
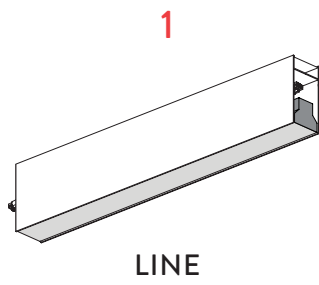
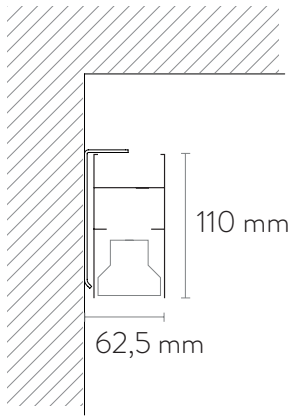

Accessories
Wall

Karma_Wall

1 Line

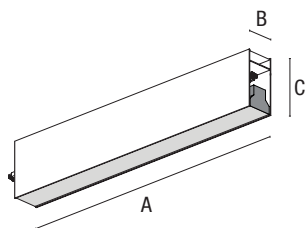

Downlight

Model	Power	Lumen output		Product dimension			* code to complete
		downlight	uplight	A	B	C	
600	12 W	1879 lm	/	573 mm	55 mm	110 mm	SE-WAAAA ■ △ ● □
1100	24 W	3758 lm	/	1131 mm	55 mm	110 mm	SE-WAABC ■ △ ● □
1700	36 W	5637 lm	/	1691 mm	55 mm	110 mm	SE-WAACD ■ △ ● □
2200	48 W	7516 lm	/	2250 mm	55 mm	110 mm	SE-WAADE ■ △ ● □

Downlight_Uplight

600	12+4 W	1879 lm	660	573 mm	55 mm	110 mm	SE-WABAB ■ △ ● □
1100	24+12 W	3758 lm	1320	1131 mm	55 mm	110 mm	SE-WABBD ■ △ ● □
1700	36+12 W	5637 lm	1320	1691 mm	55 mm	110 mm	SE-WABCE ■ △ ● □
2200	48+24 W	7516 lm	2640	2250 mm	55 mm	110 mm	SE-WABDG ■ △ ● □

Downlight_Uplight
Dual switch

1100	24+12 W	3758 lm	1320 lm	1131 mm	55 mm	110 mm	SE-WACBD ■ △ ● □
1700	36+12 W	5637 lm	1320 lm	1691 mm	55 mm	110 mm	SE-WACCE ■ △ ● □
2200	48+24 W	7516 lm	2640 lm	2250 mm	55 mm	110 mm	SE-WACDG ■ △ ● □

⊕ 220÷240Vac | IP40

UP to 157 lm/W | UP to UGR>19 | L80/B20 80.000 h. | CRI>90 | UP to RG0 | SDCM<3
Lumen output values: luminaire luminous flux at 4000 K - optics 60°

2 Accessories Wall

Description	* code to complete
Fixing bracket (2x)	ATS05201
End Cap (2x)	AT ● 07301

3 Joint

Metal connection	ATS03303
------------------	----------

Optical Info p. 528

* Select your option

CCT	Optic	Colour	Control	#
2700 K	60°	White	On/Off	Only: 120° - DALI(DT8), Casambi
3000 K	90°	Black	DALI	** Only: 1700 - 2200
4000 K	120°	Corten	Em. 1h **	*** Configurations up to max 2800 mm length
Tunable # %	Asy	Lunar Grey	Casambi ****	% Only: 1100 - 1700 - 2200
	Sym	Tobacco	Push ***	

Finishes

White Black Corten Lunar Grey Tobacco



MAYA_Wall

Le installazioni parete rappresentano un elemento centrale nell'illuminazione d'interni. Maya offre soluzioni ottimali con misure e colori. Maya si installa a parete sia con apparecchi stand alone che a sistema, si configura in tutte le dimensioni, colori e possibilità offerte dal mondo Maya. Oltre alla tradizionale applicazione in aderenza alla parete, con staffe, è disponibile la versione WALL_PENDANT, creata per risolvere installazioni specifiche.

Wall installations represent a central element in interior lighting. Maya offers optimal solutions with measurements and colors. Maya is installed on the wall with both stand alone and system luminaires, it is configured in all sizes, colors and possibilities offered by the Maya world. In addition to the traditional wall-tight application with brackets, the WALL_PENDANT version is available, created to solve specific installations.



MODEL
600
1100
1700
2200
2800

+ MAYA Pendant pag 276



+ MAYA Ceiling pag 226



+ MAYA Track pag 212



+ MAYA Recessed pag 062

EXTENDED COLLECTION

MAYA_Wall

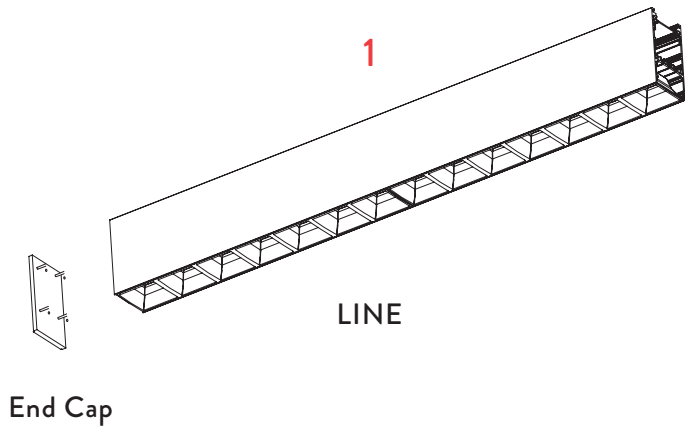
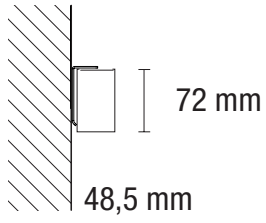

3
Joint



Metal connection

2
Accessories Wall

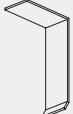

Fixing Bracket



End Cap

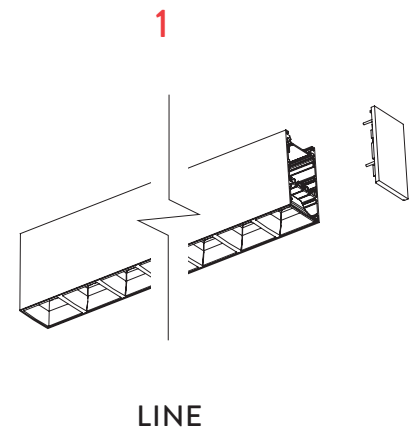

MAYA_Wall

1 Line

	Model	Power	Lumen output		*code to complete
			downlight	uplight	
Downlight	600	12 W	1518 lm	-	SM-WAAAA ■ △ ● □
	1100	24 W	3036 lm	-	SM-WAABC ■ △ ● □
	1700	36 W	4554 lm	-	SM-WAACD ■ △ ● □
	2200	48 W	6072 lm	-	SM-WAADE ■ △ ● □
	2800	60 W	7590 lm	-	SM-WAAWF ■ △ ● □
Downlight_Uplight	600	12+6 W	1518 lm	475 lm	SM-WABAB ■ △ ● □
	1100	24+12 W	3036 lm	897 lm	SM-WABBD ■ △ ● □
	1700	36+12 W	4554 lm	897 lm	SM-WABCE ■ △ ● □
	2200	48+24 W	6072 lm	1795 lm	SM-WABDG ■ △ ● □
	2800	60+36 W	7950 lm	2692 lm	SM-WABWJ ■ △ ● □
Downlight_Uplight Dual switch	1100	24+12 W	3036 lm	897 lm	SM-WACBD ■ △ ● □
	1700	36+12 W	4554 lm	897 lm	SM-WACCE ■ △ ● □
	2200	48+24 W	6072 lm	1795 lm	SM-WACDG ■ △ ● □
	2800	60+36 W	7950 lm	2692 lm	SM-WACWJ ■ △ ● □

⊕ 220÷240Vac | IP40

UP to 127 lm/W | UP to UGR≥16 | L80/B20 80.000 h. | CRI>90 | UP to RG0 | SDCM<3
Lumen output values: luminaire luminous flux at 4000 K - optics 50°

2 Accessories Wall

Description	* code to complete
Fixing bracket (2x line 600, 1100 - 3x line 1700, 2200, 2800)	CSS05201
End Cap (2x)	CS ▼ 07301

3 Joint

Metal connection	CSS03303
------------------	----------

Optical Info p. 528

* Select your option

CCT	■	Optic	△	Colour	●	Control	□	End Cap colour	▼ #	Only: 120° - DALI(DT8), Casambi
2700 K	1	120°	E	White	W	On/Off	NF	White	W	** Only: 1700 - 2200 - 2800
3000 K	2	Micro	M	Black	B	DALI	DA	Black	B	*** Configurations up to max 2800 mm length
4000 K	3	50° White	N	Corten	C	Em. 1h **	H1	Corten	C	
Tunable #	4	50° Black	O	Lunar Grey	G	Casambi	CA	Grey	G	
		80° White	P	Tobacco	O	Push ***	PU	Tobacco	O	
		80° Black	Q	Beech Wood	H			Sand	V	
		Asy White	R	Oak Wood	I			Sage Green	U	
		Asy Black	S	Walnut Wood	L					
				Antique Marble	S					

MAYA_Wall Pendant

Nuove soluzioni integrano ed ampliano il Sistema Maya. Oltre alla tradizionale applicazione parete, con staffe, è disponibile la versione WALL_PENDANT. Ideale per illuminazione di spazi in aderenza con la parete, si configura in tutte le dimensioni, colori e possibilità offerte dal mondo Maya.

New solutions integrate and extend the Maya System. Besides the traditional wall application, with wall bracket, we present the new model WALL_PENDANT is. Ideal for illuminating spaces in adherence with the wall, can be configured in all dimensions, colors and possibilities offered by the Maya world.



La connessione del profilo alla parete è totalmente invisibile. E' previsto lo spazio per il collegamento elettrico.

The connection between the profile and the wall is totally invisible. A space is reserved for the electric linking.



La parte terminale dell'apparecchio si fissa al soffitto in maniera estremamente semplice e pulita.

The terminal part of the device is fixed to the ceiling in simple and clean way.



Il secondo punto di sostegno della struttura è costituito dal cavetto di sospensione in acciaio.

Suspension detail: the second point of sustain for the structure is offered from the steel suspension cable.



MAYA_Wall Pendant

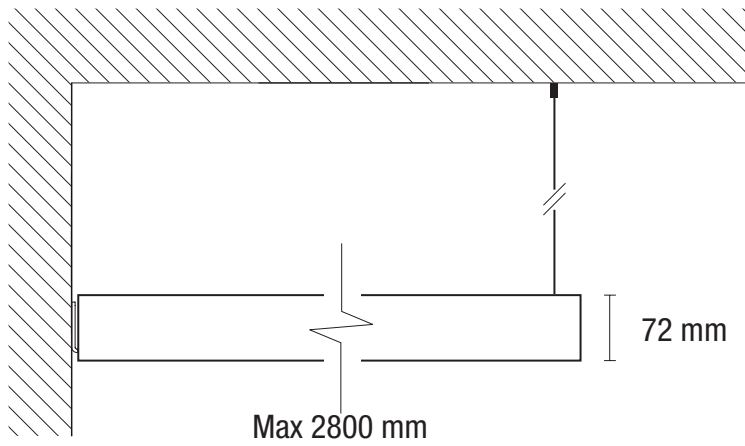

2

Accessories
Wall_Pendant

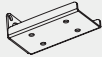

Fixing Bracket



Hanger



End Cap

This vertical grey panel lists the accessories for the Maya Wall Pendant. It includes a red number '2' at the top, followed by the heading 'Accessories Wall_Pendant'. Below this are three items: a 'Fixing Bracket' (a small metal plate with four holes), a 'Hanger' (a vertical rod with a hook at the top and a base at the bottom), and an 'End Cap' (a rectangular cap with a notch on one side).

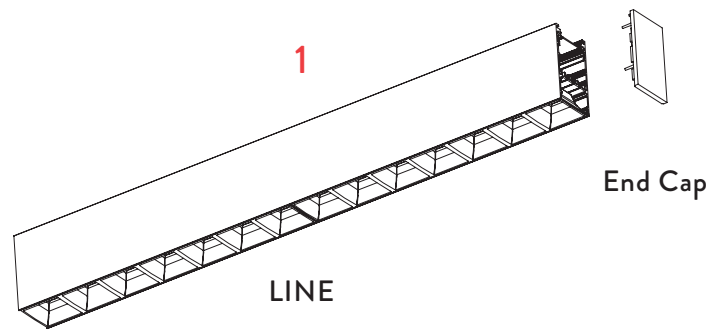

MAYA_Wall Pendant

1 Line

	Model	Power	Lumen output		*code to complete
			downlight	uplight	
Downlight	600	12 W	1518 lm	-	SM-HAAAA ■ △ ● □
	1100	24 W	3036 lm	-	SM-HAABC ■ △ ● □
	1700	36 W	4554 lm	-	SM-HAACD ■ △ ● □
	2200	48 W	6072 lm	-	SM-HAADE ■ △ ● □
	2800	60 W	7590 lm	-	SM-HAAWF ■ △ ● □
Downlight_Uplight	600	12+4 W	1518 lm	299 lm	SM-HABAB ■ △ ● □
	1100	24+12 W	3036 lm	897 lm	SM-HABBD ■ △ ● □
	1700	36+12 W	4554 lm	897 lm	SM-HABCE ■ △ ● □
	2200	48+24 W	6072 lm	1795 lm	SM-HABDG ■ △ ● □
	2800	60+36 W	7950 lm	2692 lm	SM-HABWJ ■ △ ● □
Downlight_Uplight Dual switch	1100	24+12 W	3036 lm	897 lm	SM-HACBD ■ △ ● □
	1700	36+12 W	4554 lm	897 lm	SM-HACCE ■ △ ● □
	2200	48+24 W	6072 lm	1795 lm	SM-HACDG ■ △ ● □
	2800	60+36 W	7950 lm	2692 lm	SM-HACWJ ■ △ ● □

⊕ 220÷240Vac | IP40

UP to 127 lm/W | UP to UGR≥16 | L80/B20 80.000 h. | CRI>90 | UP to RG0 | SDCM<3
Lumen output values: luminaire luminous flux at 4000 K - optics 50°

2 Accessories Wall_Pendant

Description	* code to complete
End Cap	CS ▼ 07301
Hanger	CSPP00 ● ●
Fixing Bracket	CSS05203

Optical Info p. 528

* Select your option

CCT	Optic	Colour	Control	End Cap colour	Pendant colour	Steel cable length
2700 K 1	120° E	White W	On/Off NF	White W	Steel A	1,5 1
3000 K 2	Micro M	Black B	DALI DA	Black B	Black B	3 2
4000 K 3	50° White N	Corten C	Em. 1h ** H1	Corten C		5 3
Tunable # 4	50° Black O	Lunar Grey G	Casambi CA	Grey G		
	80° White P	Tobacco O	Push *** PU	Tobacco O		
	80° Black Q	Beech Wood H		Sand V		
	Asy White R	Oak Wood I		Sage Green U		
	Asy Black S	Walnut Wood L				
		Antique Marble S				

Only: 120° - DALI (DT8), Casambi

** Only: 1700 - 2200 - 2800

*** Configurations up to max
2800 mm length

MAYA_mini Wall/Ceiling



Maya_Mini nelle versioni installabili a PARETE – SOFFITTO esalta le ridotte dimensioni del profilo e ne aumenta attrattiva e funzionalità. Questa soluzione offre una vasta scelta su tipologia, dimensioni ed orientabilità mantenendo l'esclusività su finiture e prestazioni. Due i modelli di base : installazione fissa oppure con flusso luminoso orientabile. Le dimensioni variano dai 300 mm del modello più piccolo si arriva ai 2200 mm della versione più grande. Tante le tipologie funzionali: colori della scheda led, ottiche, dimmerazioni. A queste infinite variabili si aggiunge la scelta della gamma colori. Oltre i classici bianco e nero si spazia in combinazioni accattivanti facilmente selezionabili con il configuratore dedicato.

Maya_Mini, in its wall and ceiling installable versions, enhances the compact size of the profile and increases its attractiveness and functionality. This solution offers a wide range of options in terms of type, dimensions, and adjustability while maintaining exclusivity in finishes and performance. There are two basic models: fixed installation or adjustable light flow. The sizes range from 300 mm for the smallest model to 2200 mm for the largest version. There are various functional options available, such as LED board colors, optics, and dimming capabilities. In addition to these infinite variables, there is also a choice of color range. Beyond the classic white and black, there are captivating combinations easily selectable with the dedicated configurator.



+ MAYA_mini Ceiling pag 234



+ MAYA_mini Pendant pag 284



+ MAYA_mini Floor pag 402

EXTENDED
COLLECTION

MAYA_mini

ADJ

L'allargamento della gamma Maya_Mini propone soluzioni all'avanguardia nella tecnologia e nell'estetica. Maya_Mini_Adj si candida ad occupare un posto di rilievo nella sezione della luce proiettata. Le ottiche in uso sul sistema vengono proposte con schede Led di diversa dimensione: 300/600/900 mm. Flussi luminosi importanti, con ottiche a scelta tra 50° ed 80°, possono essere installate a soffitto, a parete, a terra. Orientabilità del flusso luminoso di 120° a destra e sinistra sull'asse.

The expansion of Maya_Mini range offers cutting-edge solutions in aesthetics and technology. Maya_Mini_Adj is a candidate for a prominent place in our projected light section. The optics used on the system are offered with Led boards of different sizes: 300/600/900 mm. Important luminous fluxes, with optics between 50° and 80°, can be installed on the ceiling, wall, ground. Lumen flux can be adjusted 120° on right and left of central axis.

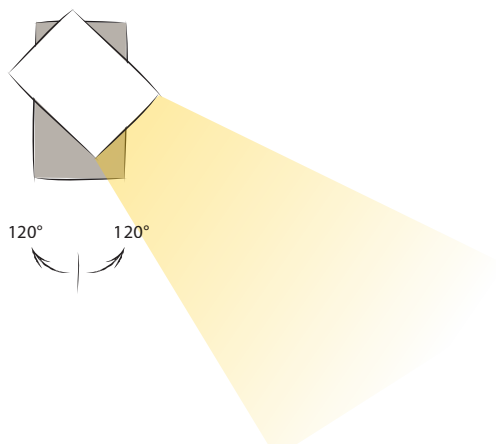

MAYA_mini Adj

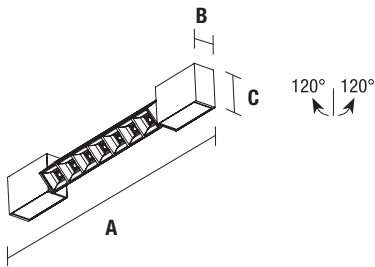

Model	Power	Lumen output	Product dimension			* code to complete
			A	B	C	
300 mm	8 W	990 lm	489 mm	42 mm	72 mm	MM-OAVQ ■ ▲ □ ● ☺ ▼
600 mm	16 W	1975 lm	769 mm	42 mm	72 mm	MM-OAAA ■ ▲ □ ● ☺ ▼
900 mm	24 W	2965 lm	1066 mm	42 mm	72 mm	MM-OAUR ■ ▲ □ ● ☺ ▼

⊕ 220÷240Vac | IP40

UP to 123 lm/W | L80/B20 80.000 h. | CRI>90 | UP to RG0 | SDCM<3
Lumen output values: luminaire luminous flux at 4000 K - optics 50°

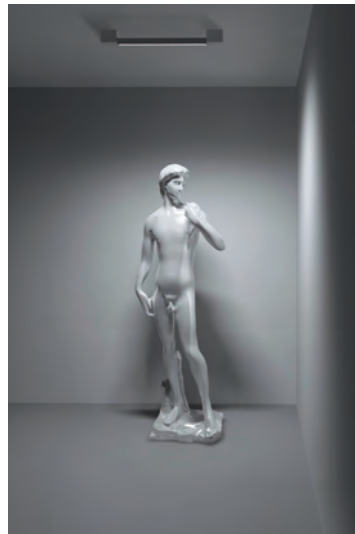

* Select your option

CCT	■	Optic	▲	Control	□	Colour central module	●	Colour side modules	☺	End Cap colour	▼
2700 K	1	120°	E	On/Off	NF	White	W	White	WW	White	W
3000 K	2	Micro	M	DALI **	DA	Black	B	Black	BB	Black	B
4000 K	3	50° White	N	Push **	PU	Lunar Grey	G	Lunar Grey	GG	Grey	G
		50° Black	O			Tobacco	O	Tobacco	OO	Tobacco	O
		80° White	P			Old Zebra	M	Beech Wood	HH	Sand	V
		80° Black	Q			Green Grass	N	Oak Wood	II	Sage Green	U
						Oman Red	P	Walnut Wood	LL		
						Desert Camouflage	Q	Antique Marble	SS		
						Beech Wood	H				
						Oak Wood	I				
						Walnut Wood	L				
						Antique Marble	S				
						Concrete	T				

** only 600 - 900

MATCH





Match si installa a parete ed è indicato per effetti di luce lineare. Realizzato in alluminio verniciato bianco opaco, è dotato di schermo in policarbonato diffondente, di sorgente SMD LED ad alta efficienza e di driver elettronico integrato nell'apparecchio. L'emissione è bidirezionale verso l'alto e verso il basso, per effetti di luce radente sulla parete.

Match is installed on the wall and is suitable for linear lighting effects. Made of opaque white painted aluminium, it is equipped with a diffusing polycarbonate screen, a high efficiency SMD LED source and an electronic driver integrated in the luminaire. The emission is bidirectional upwards and downwards, due to grazing light effects on the wall.

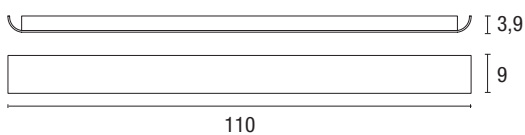
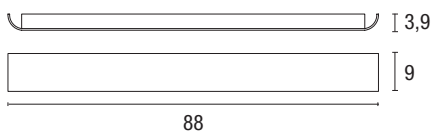
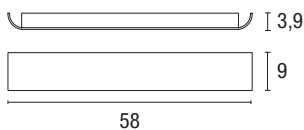

Description	Power	CCT	Source	Lumen Output	Colour	Weight	Code
58 cm	20 W	3000K	SMD Led	1625 lm	White	1,1 kg	PAR04111
		4000K	SMD Led	3600 lm	White	1,1 kg	PAR04112
88 cm	32 W	3000K	SMD Led	2808 lm	White	1,8 kg	PAR04211
		4000K	SMD Led	5500 lm	White	1,8 kg	PAR04212
110 cm	40 W	3000K	SMD Led	5900 lm	White	2,2 kg	PAR04311
		4000K	SMD Led	7600 lm	White	2,2 kg	PAR04312

220÷240Vac | IP20

Finishes

White

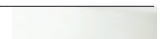

ONDA

Onda è realizzato in alluminio verniciato bianco opaco. È dotato di schermo in vetro diffondente ed è equipaggiato con sorgente SMD LED ad alta efficienza e driver integrato. È l'ideale per effetti di luce indiretta ed è in grado di illuminare l'area circostante con luce diffusa. Grazie al grado di protezione IP54 è installabile in ambienti interni ed esterni.

Onda is made of matt white painted aluminium. It has a diffusing glass screen and is equipped with a high efficiency SMD LED source and integrated driver. It is ideal for indirect light effects and is able to illuminate the surrounding area with diffused light. Thanks to the degree of protection IP54, it can be installed in indoor and outdoor.



Optical Info p. 537

Description	Power	Source	Lumen Output	CCT	Weight	Code
White	15 W	SMD LED	1270 lm	3000K	1,2 kg	PAR00012

⊕ 220÷240Vac | IP54

ELLE

Elle è realizzato in alluminio verniciato bianco opaco ed è dotato di schermo in vetro diffondente. Si installa a parete ed è completo di sorgente LED ad alta efficienza e di driver integrato. È particolarmente indicato per l'illuminazione diffusa dell'ambiente grazie alla sua emissione "uplight".

Elle is made of matt white painted aluminium and is equipped with a diffusing glass screen. It can be installed on the wall and is complete with high efficiency LED source and integrated driver. It is particularly suitable for diffused lighting of the environment thanks to its "uplight" emission.

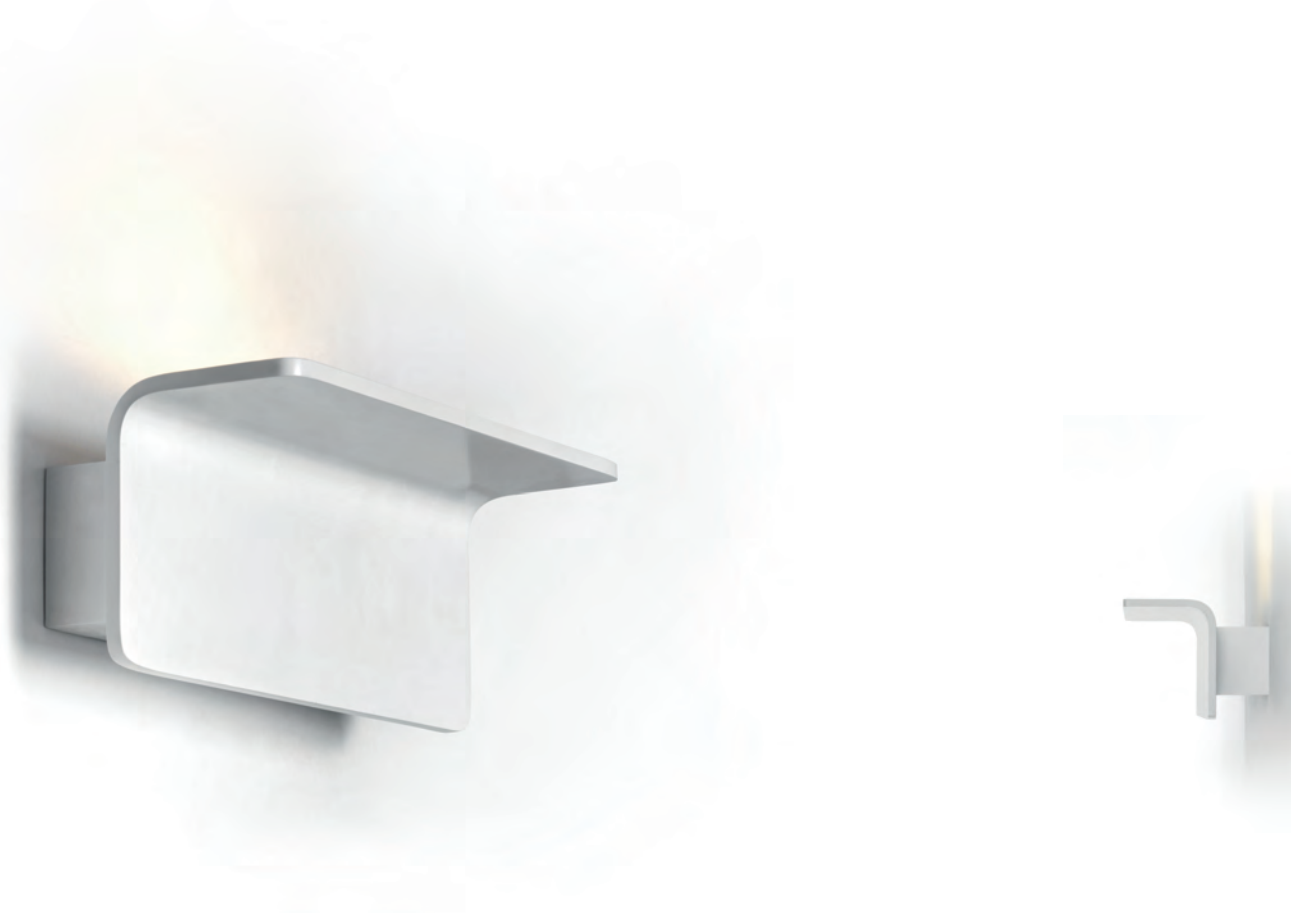
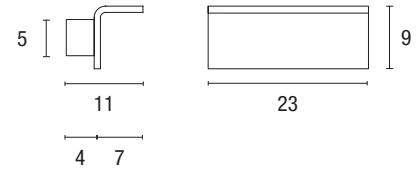

Optical Info p. 537

Description	Power	Source	Lumen Output	CCT	Weight	Code
White	24 W	CoB LED	2230 lm	3000K	1 kg	PAR00016

⊕ 220÷240Vac | IP20

GRACE

Grace, realizzata in alluminio, è particolarmente indicata per l'illuminazione diffusa negli ambienti interni. Utilizza una scheda LED da 5 W ideale per illuminazione d'accento. È disponibile in colore bianco o bicolore: bianco per la parte interna a vista e alluminio naturale per la parte esterna. L'alimentatore si trova all'interno della base.

Grace, made of aluminium, is particularly suitable for indoor application. It uses a 5W LED board ideal for accent lighting. It is available in white or two-tone: white for the inside and natural aluminum for the outside. The power supply is located inside the base.

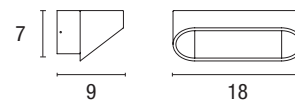
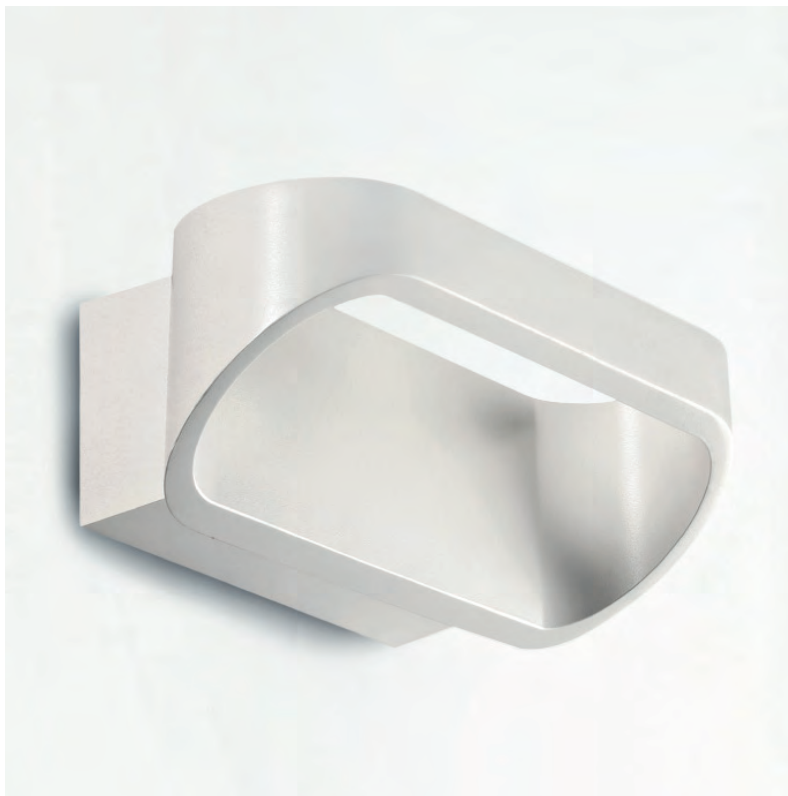

Description	Colour	Power	Source	Lumen Output	CCT	Weight	Code
18 cm	Aluminum - White	5 W	Power LED	310 lm	3000K	0,6 kg	PAR264
18 cm	White	5 W	Power LED	310 lm	3000K	0,6 kg	PAR265

⊕ 220=240Vac | IP20

ECLIS

Apparecchio da parete con grado di protezione IP54. Realizzato con corpo in alluminio verniciato e schermo in materiale plastico. È equipaggiato con sorgente CoB LED ad alta efficienza e driver integrato. L'apparecchio è dotato di testa girevole che, ruotando sull'asse orizzontale, permette di creare effetti di luce personalizzati sulla parete.

Wall-mounted luminaire with IP54 protection degree. Made with painted aluminium body and plastic screen. It is equipped with a high efficiency CoB LED source and integrated driver. The device is equipped with a swivel head which, by rotating on the horizontal axis, allows you to create personalized light effects on the wall.

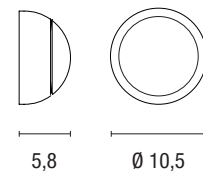

Description	Power	Power	Source	Lumen Output	CCT	Weight	Code
Ø 10,5 cm	White	4 W	CoB LED	250 lm	3000K	0,6 kg	PAR00075

⊕ 220÷240Vac | IP54

POLKA

Polka è un segnapasso per l'illuminazione dei percorsi in interni e in esterni. Realizzato in pressofusione di alluminio verniciato, è dotato di cavo di alimentazione in neoprene tipo H05RN-F. Polka è particolarmente indicato per le installazioni in outdoor. Grazie alla sua emissione asimmetrica e alla sorgente led arretrata nel corpo, illumina il pavimento in modo confortevole e senza abbagliamento. E' completo di pozzetto di installazione in PVC.

Polka is a path lighter for indoor and outdoor applications. Painted die-cast aluminum, it is equipped with a H05RN-F neoprene power cable. It is particularly suitable for outdoor installations. Thanks to its asymmetrical emission and to the led source hidden in the body, it illuminates the floor comfortably and without glare. PVC housing included.



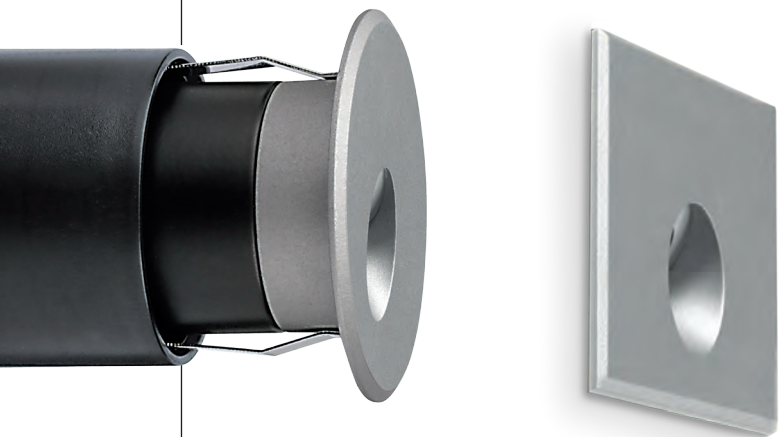

Installabile in parete piena con pozzetto in dotazione, oppure in parete a pannelli di spessore minimo 10 mm. senza pozzetto.

Suitable for mounting in concrete wall (sleeve included) or in vertical panels of minimum thickness 10 mm. (sleeve not needed).

Round 3 W

Square 3 W

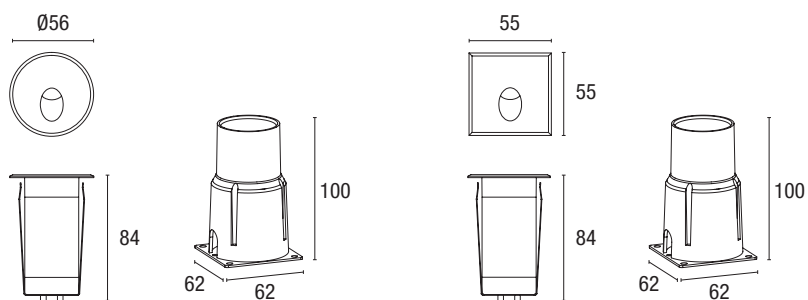

Optical Info p. 537

Model	Colour	Size	Power	Source	Light Output	CCT	Weight	Optic	Code
Round	Grey	Ø 56 mm	3 W	POWER LED	120 lm	3000 K	0,32 kg	30°	EST54017
				POWER LED	150 lm	4000 K	0,32 kg	30°	EST54015
Square	Grey	55x55 mm	3 W	POWER LED	150 lm	3000 K	0,32 kg	30°	EST54018
				POWER LED	150 lm	4000 K	0,32 kg	30°	EST54016

⊕ 220÷240Vac | IP65 | IK10

Finishes

Grey



FAST

Gli apparecchi segnapasso da parete FAST permettono di illuminare i percorsi con una luce confortevole e priva di abbagliamento. Tutte le versioni sono IP65 e sono installabili sia in ambienti interni che in outdoor. Sempre con driver incluso, Fast è disponibile in diverse configurazioni: con ottiche asimmetriche per l'illuminazione diretta del pavimento, o con ottiche diffondenti per luce generalmente soffusa; fra queste, la versione "no frame" è completa di vetro satinato montato su telaio non in vista. Completa la gamma la versione per luce d'emergenza completa di led di segnalazione; tutte le versioni da 3,6 W sono installabili direttamente nella scatola standard 503 per ottimizzare le soluzioni impiantistiche; le placchette estetiche sono realizzate in pressofusione di alluminio, verniciate nei colori bianco e grigio.

FAST wall-mounted pathway luminaires allow you to illuminate paths with a light comfortable and glare-free. All versions are IP65 and can be installed both indoors and outdoors. Always with driver included, Fast is available in different configurations: with asymmetrical optics for direct floor lighting, or with diffusing optics for generally soft light; among these, the "no frame" version is complete with frosted glass with frame totally hidden. The range is completed by the version for emergency light complete with signaling LED; all 3.6 W versions can be installed directly in the standard 503 box to optimize the system solutions; the plates are made of die-cast aluminum, coated in white and gray.



FAST_Diffuser

Telaio nascosto / Hidden frame

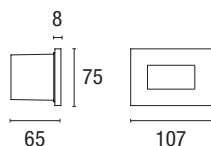

Optical Info p. 537

Power	Colour	Code	Source	Lumen Output	CCT	Optic	Weight
3,6 W	White	INC59006	SMD Led	40 lm	3000 K	150°	0,3 kg

⊕ 220÷240Vac | IP65

Telaio a vista / Visible frame

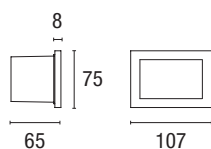

Optical Info p. 537

Description	Power	Code	Source	Lumen Output	CCT	Optic	Weight
White	3,6 W	INC59010	SMD Led	40 lm	3000 K	150°	0,3 kg
Grey	3,6 W	INC59011	SMD Led	40 lm	3000 K	150°	0,3 kg

⊕ 220÷240Vac | IP65



Compatibile con scatola 503
Suitable for 503 box

FAST_Asymmetric

Orizzontale asimmetrico /Asymmetric horizontal

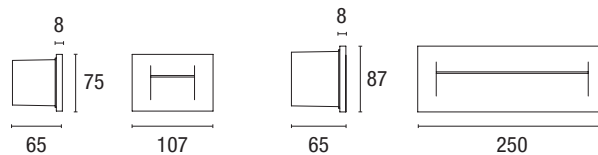

Optical Info p. 537

Power	Colour	Code	Source	Lumen Output	CCT	Optic	Weight
3,6 W	White	INC59000	SMD Led	60 lm	3000 K	AS	0,3 kg
	Grey	INC59001					
8,5 W	White	INC59004	SMD Led	205 lm	3000 K	AS	0,7 kg
	Grey	INC59005					

⊕ 220÷240Vac | IP65

Verticale asimmetrico /Asymmetric vertical

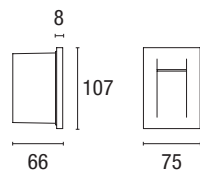

Optical Info p. 537

Power	Colour	Code	Source	Lumen Output	CCT	Optic	Weight
3,6 W	White	INC59002	SMD Led	70 lm	3000 K	150°	0,3 kg
3,6 W	Grey	INC59003					

⊕ 220÷240Vac | IP65

FAST_Emergency

La versione di Fast Emergenza può funzionare sia in modalità per luce “permanente” sia in modalità per luce “non permanente”. La selezione della modalità avviene tramite un apposito miniswitch posizionato sul retro dell'apparecchio. Fast Emergenza è completo di led di segnalazione verde a vista per l'indicazione dello stato di alimentazione; è dotato di converter e batteria 3.6V 0.6Ah NiCd che garantisce un'autonomia di 1 h. ricaricandosi in 24 h. Fast Emergenza si installa in scatola standard 503 e si alimenta in Classe II a 230 VAC 50/60 Hz).

The Fast Emergency version can work both in “permanent” and “non-permanent” lighting mode. The mode is selected by a specific miniswitch located on the back of the fixture. Fast Emergency is complete with visible green signaling LED to indicate the power supply status; it is equipped with a converter and 3.6V 0.6Ah NiCd battery that ensure 1 h. of authonomy and a recharging time of 24 h. Fast Emergenza is installed in a standard 503 box and is feeded in Class II at 230 VAC 50/60 Hz).



Compatibile con scatola 503
Suitable for 503 box

Emergenza orizzontale / Emergency horizontal

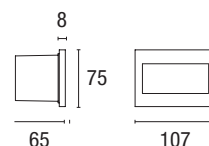
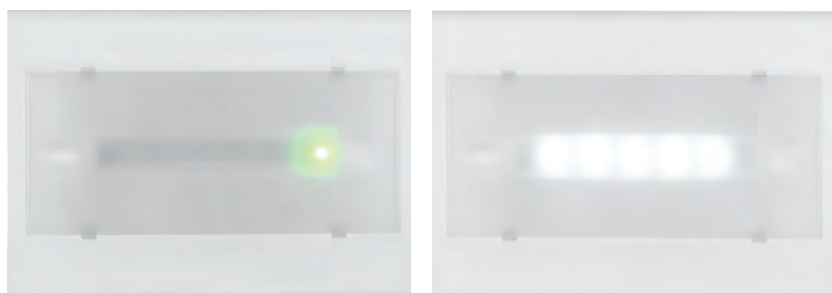

Optical Info p. 537

Power	Colour	Code	Operation time	Source	Switching time	Recharging time	Weight
3,6 W	White	INC59600EM	1 hour	SMD Led	0,5 sec	24 h.	0,3 kg

ALYSON

Alyson viene proposto in 3 diverse misure, il corpo lampada è realizzato in gesso con particolare attenzione al livello della finitura. Se verniciato nei colori della parete si integra perfettamente nell'ambiente. Monta una scheda Led 3000K/4000K ed è completo di alimentazione.

Alyson is available in 3 different sizes. The lamp body is made of plaster and particular attention is paid to the finish. If painted in the same colours of the wall, it integrates perfectly into any environment. It is equipped with 2 x 3000K/4000K Led boards and complete with power supply.





Plaster

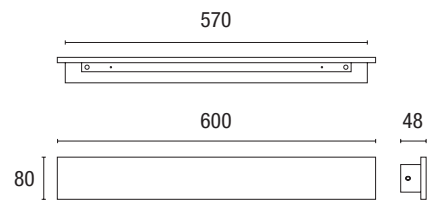
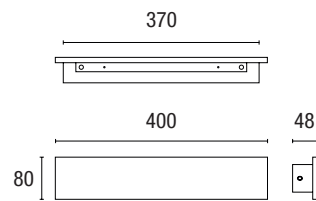
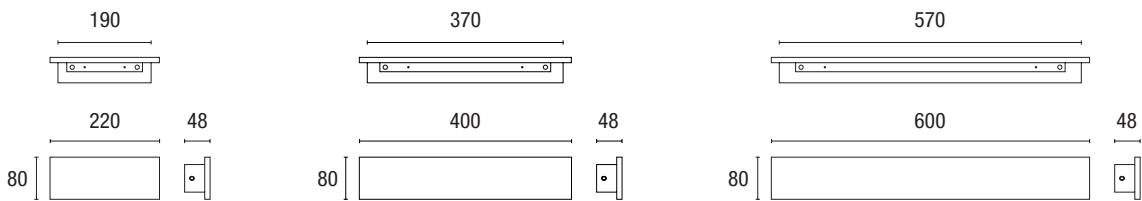
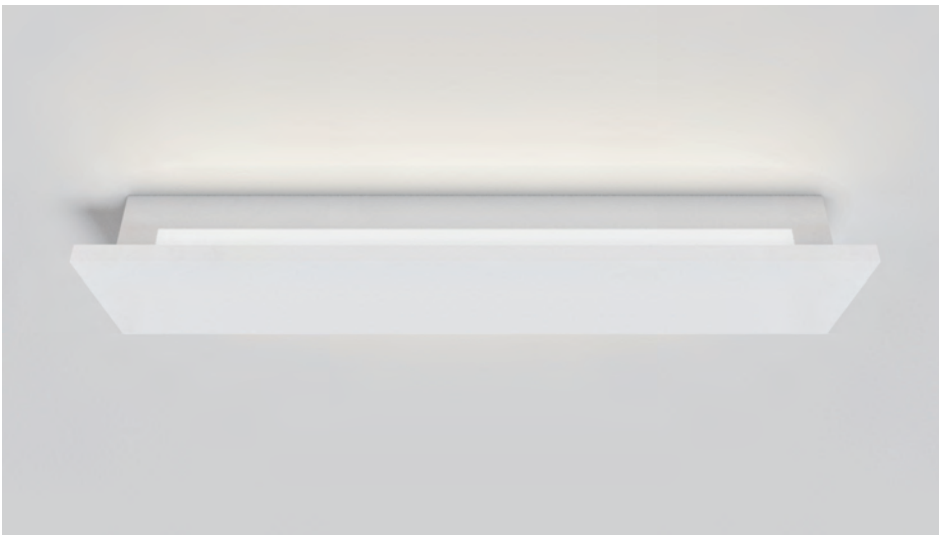
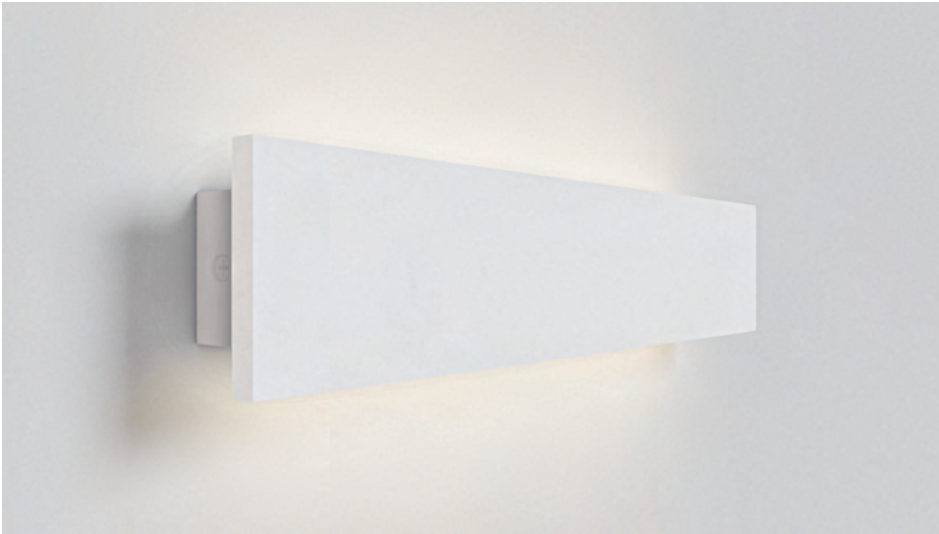

Description	Power	CCT	Source	Lumen Output	Colour	Weight	Code
22 cm	8 W	3000K	SMD Led	950 lm	White	1 kg	PAR10329
40 cm	12 W	3000K	SMD Led	1200 lm	White	1,25 kg	PAR10330
60 cm	20 W	3000K	SMD Led	1600 lm	White	1,8 kg	PAR10331

⊕ 220÷240Vac | IP20

Finishes

White



POD

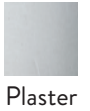

Plaster

Pod si installa a parete; è realizzato in gesso liscio bianco che rende l'apparecchio verniciabile esternamente anche dopo l'installazione; dotato di sorgente LED ad alta efficienza integrata e di driver è indicato per l'illuminazione diffusa dell'ambiente con luce indiretta.

Pod is installed on the wall; it is made of smooth white plaster which makes the device paintable externally even after installation; equipped with integrated high efficiency LED source and driver, it is suitable for diffused lighting of the environment with indirect light.

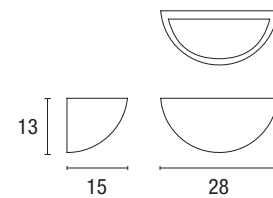

Description	Colour	Power	Source	Lumen Output	CCT	Weight	Code
28 cm	White	6,3 W	SMD LED	520 lm	3000K	2 kg	PAR10327

⊕ 220÷240Vac | IP20

BOREALE



Plaster

Boreale si installa a parete ed è verniciabile esternamente anche dopo la prima installazione. L'emissione di luce è bidirezionale e consente di ottenere effetti di luce radente sulla parete. Il Corpo è realizzato in gesso liscio bianco ed è completo di schermo in vetro diffondente, di sorgente LED ad alta efficienza e di driver integrato. Completa la gamma la versione per sorgenti luminose con attacco E14.

Boreale can be installed in walls and can be painted externally even after the first installation. The light emission is bidirectional and allows to obtain grazing light effects on the wall. The body is made of smooth white plaster and is complete with diffusing glass screen, high efficiency LED source and integrated driver. The range is completed by the version for light sources with E14 socket.

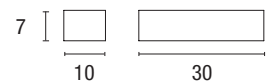

Description	Colour	Power	Source	Socket	Lumen Output	CCT	Weight	Code
LED / IAA *	White	max. 15 W	LED / IAA	E14	/	/	1,3 kg	PAR310
SMD LED *	White	2x 6 W	SMD LED	/	2x 500 lm	3000 K		PAR10326

⊕ 220÷240Vac | IP20

* Lamp not included

IDRA



Plaster

Apparecchio da parete. Il corpo dell'apparecchio è realizzato in gesso liscio bianco, che lo rende verniciabile esternamente anche dopo la prima installazione. Sorgente LED ad alta efficienza integrata. Emissione bidirezionale per effetti di luce radente sulla parete. Driver elettronico integrato nell'apparecchio.

Wall mounted fixture. The body is made of smooth white plaster, which makes it paintable externally even after the first installation. Integrated high efficiency LED source. Bidirectional emission for grazing light effects on the wall. Electronic driver integrated.

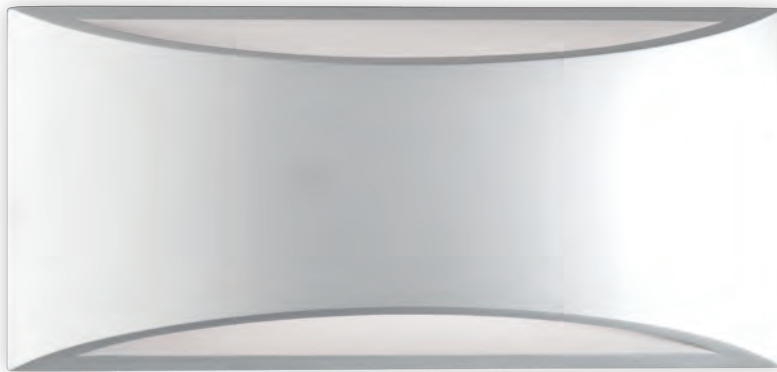
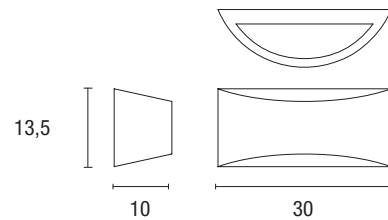

Description	Colour	Power	Source	Lumen Output	CCT	Weight	Code
30 cm	White	2x 6 W	SMD LED	2x 500 lm	3000K	1,5 kg	PAR10328

⊕ 220÷240Vac | IP20

TUBE



Plaster

Apparecchio da parete. Corpo in gesso liscio bianco verniciabile esternamente. Schermo diffondente e frontale antiabbagliamento. Equipaggiato con attacco GU10. Emissione monodirezionale o bidirezionale per effetti di luce radente sulla parete.

Wall mounted fixture. White smooth plaster body externally paintable. Diffusing screen and anti-glare front. Equipped with GU10 socket. Monodirectional or bidirectional emission for grazing light effects on the wall.

Downlight

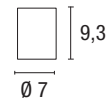

Uplight / Downlight

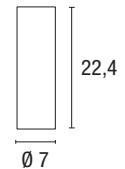

Description	Colour	Power	Source	Socket	Lumen Output	Weight	Code
Downlight	White	1x max. 35 W	LED	GU10	/	0,4 kg	PAR10000
Uplight / Downlight	White	2x max. 35 W	LED	GU10	/	0,8 kg	PAR10002

OBERON



Plaster

Apparecchio da parete. Corpo in gesso liscio bianco verniciabile esternamente. Schermo diffondente e frontale antiabbagliamento. Sorgente LED ad alta efficienza integrata. Emissione bidirezionale per effetti di luce radente sulla parete. Driver elettronico integrato nell'apparecchio. Corpo dell'apparecchio verniciabile.

Wall luminaire. White polished plaster body externally paintable. Front antiglare diffuser. Integrated high efficiency LED light source. Bidirectional emission for grazing light effects. Electronic driver integrated in the fixture.

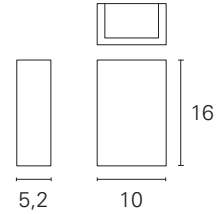

Description	Colour	Power	Source	Lumen Output	CCT	Weight	Code
Uplight / Downlight	White	2x 3 W	Power LED	300 lm	3000K	0,7 kg	PAR321

⊕ 220÷240Vac | IP20

ELI



Plaster

Apparecchio da parete. Corpo in gesso liscio bianco verniciabile esternamente. Schermo diffondente e frontale antiabbagliamento. Sorgente LED ad alta efficienza integrata. Emissione bidirezionale per effetti di luce radente sulla parete. Driver elettronico integrato nell'apparecchio.

Wall luminaire. White polished plaster body externally paintable. Front antiglare diffuser. Integrated high efficiency LED light source. Bidirectional emission for grazing light effects. Electronic driver integrated in the fixture.

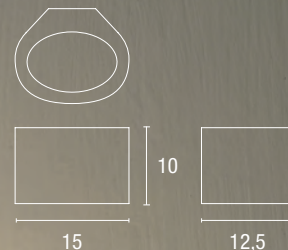

Description	Colour	Power	Source	Lumen Output	CCT	Weight	Code
Uplight / Downlight	White	5 W	CoB LED	220 lm	3000K	1,5 kg	PAR10325

⚡ 220÷240Vac | IP20

LUPIN



p.308

La serie di apparecchi Lupin è realizzata in alluminio verniciato bianco opaco. Attacco GU10. Lupin è progettato illuminare con effetti di luce spot; la gamma prevede diverse configurazioni per l'installazione a parete o a soffitto, e si completa con le versioni in coordinato per l'installazione a sospensione.

The Lupin luminaire series is made of matt white painted aluminium. GU10 socket. Lupine is designed to illuminate with concentrated light effects; the range includes different configurations for wall or ceiling installation and is completed with coordinated versions for suspended installation.

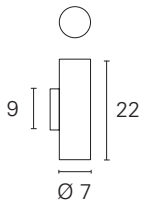

Description	Colour	Power	Source	Socket	Lumen Output	CCT	Weight	Code
Uplight / Downlight	White	2x 7 W	LED	GU10	2x 550 lm	3000K	0,6 kg	PAR00018

Lamp included



Wall 1x Spot

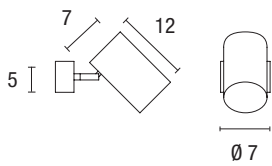

Wall 2x Spots

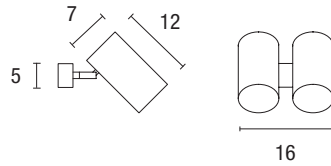

Description	Colour	Power	Source	Socket	Lumen Output	CCT	Weight	Code
1x Spot	White	7 W	LED	GU10	550 lm	3000 K	0,5 kg	PAR243
2x Spots	White	2x 7 W	LED	GU10	2x 550 lm	3000 K	0,8 kg	PAR00024

⊕ 220÷240Vac | IP20

Lamp included

DIPPY

Dippy è un proiettore installabile a parete o a soffitto. È realizzato in metallo verniciato bianco opaco o nero opaco ed è completo di schermo diffondente. Il particolare piano inclinato che ne caratterizza il design permette l'orientabilità del proiettore di 90°. Equipaggiato con sorgente CoB LED ad alta efficienza e driver integrato si utilizza per effetti di luce spot.

Dippy is a projector that can be installed on the wall or ceiling. It is made of matt white or matt black painted metal and is complete with a diffusing screen. The peculiar inclined plane that characterizes its design allows the projector to be adjusted by 90°. Equipped with a high efficiency CoB LED source and integrated driver, it is used to obtain spotlight effects.

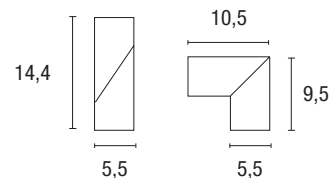

Optical Info p. 537

Description	Power	Source	Lumen Output	CCT	Weight	Code
White	7 W	CoB LED	600 lm	3000 K	1 kg	PAR282
Black	7 W	CoB LED	600 lm	3000 K	1 kg	PAR281

⊕ 220÷240Vac | IP40

Finishes

White

Black



PAKO



p.306

Pako è un proiettore installabile a parete e a soffitto. È realizzato in metallo verniciato bianco opaco o nero opaco ed è completo di schermo diffondente. Il corpo principale si caratterizza per il taglio inclinato sul quale la testa ottica può ruotare di 90°. Pako è completo di LED ad alta efficienza e driver integrato, si utilizza per effetti di luce spot e si abbina alla serie di apparecchi a sospensione Stek.

Pako is a projector for wall mounting or ceiling mounting. It is made of matt white or matt black painted metal and is complete with a diffusing screen. The main body is characterized by the inclined cut on which the optical head can rotate 90°. Pako is complete with high efficiency LEDs and integrated driver, it is used for spotlight effects and is combined with the Stek pendant fixture series.

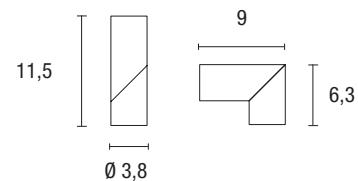

Optical Info p. 537

Description	Power	Source	Lumen Output	CCT	Weight	Code
White	4 W	SMD LED	320 lm	3000 K	0,3 kg	SOP08111
Black	4 W	SMD LED	320 lm	3000 K	0,3 kg	SOP08121

⊕ 220÷240Vac | IP20

Finishes

White

Black



BERLIN

Lampada da parete per lettura. Corpo in alluminio verniciato. Braccio flessibile ed orientabile. Sorgente LED ad alta efficienza integrata. Per luce diretta per accenti luminosi. Driver elettronico integrato nell'apparecchio. Emissione con fascio di apertura a 30°. Interruttore On/Off e presa USB integrata nella parte inferiore della basetta di fissaggio.

Wall reading lamp. Painted aluminium body. Adjustable and flexible arm. Integrated high efficiency LED light source. Direct lighting for bright accents. Electronic driver integrated in the fixture. Beam angle 30°. On/Off and USB on the base.

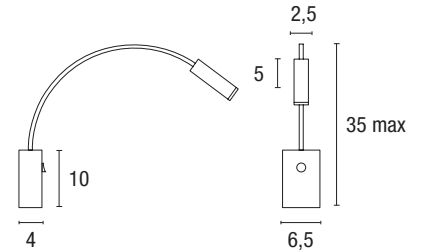

Usb



Description	Power	Source	Lumen Output	CCT	Weight	Code
White	3 W	Power LED	190 lm	3000 K	0,5 kg	RGL02110
Black	3 W	Power LED	190 lm	3000 K	0,5 kg	RGL02120

□ 220÷240Vac | IP20

Finishes

White

Black



LONDON

Lampada da parete per lettura. Corpo in alluminio verniciato. Braccio flessibile ed orientabile. Sorgente LED ad alta efficienza integrata. Per luce diretta per accenti luminosi. Driver elettronico integrato nell'apparecchio. Emissione con fascio di apertura a 30°. Interruttore On/Off sulla base.

Wall reading lamp. Painted aluminium body. Adjustable and flexible arm. Integrated high efficiency LED light source. Direct lighting for bright accents. Electronic driver integrated in the fixture. Beam angle 30°. On/Off on the base.

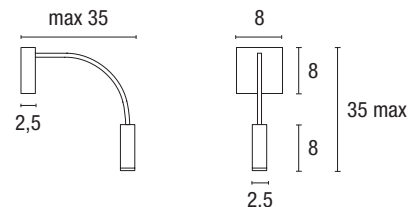

Description	Power	Source	Lumen Output	CCT	Weight	Code
White	3 W	Power LED	190 lm	3000 K	0,4 kg	RGL03110
Black	3 W	Power LED	190 lm	3000 K	0,4 kg	RGL03120

220÷240Vac | IP20

Finishes

White

Black



PARIS

Apparecchio da parete. Corpo in alluminio verniciato o cromato. Braccio flessibile ed orientabile. Sorgente LED ad alta efficienza integrata. Per luce diretta per accenti luminosi. Driver elettronico integrato nell'apparecchio. Interruttore On/Off sulla base.

Wall luminaire. Painted or chromed aluminium body. Adjustable and flexible arm. Integrated high efficiency LED light source. Direct lighting for bright accents. Electronic driver integrated in the fixture. On/Off on the base.



Description	Colour	Power	Source	Lumen Output	CCT	Weight	Code
Flexible Arm	White	2 W	Power LED	150 lm	3000 K	0,4 kg	PAR00254
Flexible Arm	Chrome	2 W	Power LED	150 lm	3000 K	0,4 kg	PAR00255
Flexible Arm	Steel	2 W	Power LED	150 lm	3000 K	0,4 kg	PAR00256

☐ 220÷240Vac | IP20

SOFT_Wall

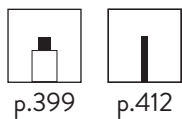

Apparecchio da parete. Paralume in tessuto. Struttura in metallo cromato. Per lampade con attacco E27 o equivalenti a LED. Per effetti di luce diffusa. Lampada non inclusa. Interruttore On/Off sulla base.

Wall luminaire. Fabric shade. Chrome body. For E27 light bulb or LED equivalent. For diffused light effects. Bulb not included. Switch On/Off on the base.

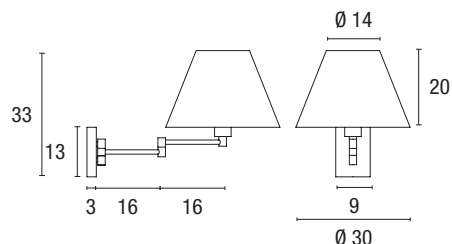

Description	Colour	Power	Source	Socket	Weight	Code
Wall Mounting	Chrome - White	1x max. 15 W	LED / FBT E27	E27	1,6 kg	PAR097

⊕ 220÷240Vac | IP20

Lamp not included

CAMA

Lampada da parete per lettura. Corpo in alluminio verniciato a sezione tonda o quadrata. Testa orientabile sul piano orizzontale e sul piano verticale per il puntamento della luce. Sorgente LED ad alta efficienza e driver elettronico integrato nell'apparecchio. Interruttore On/Off sulla base.

Wall lamp for reading. Painted aluminium body with round or square section. Head adjustable on the horizontal plane and on the vertical plane for pointing the light. High efficiency LED source and electronic driver integrated in the fixture. On/Off switch on the base.



Square Wall mounting

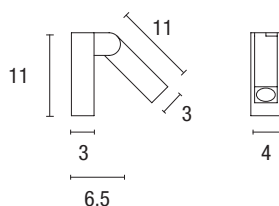

Round Wall mounting

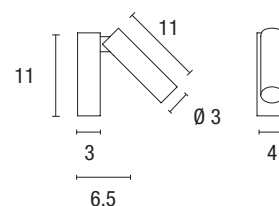

Description	Colour	Power	Source	Lumen Output	CCT	Weight	Code
Square	White	2 W	Power LED	130 lm	3000 K	0,5 kg	PAR00035
Round	White	2 W	Power LED	130 lm	3000 K	0,5 kg	PAR00037

⊕ 220÷240Vac | IP20

JAZZ

Apparecchio da parete. Paralume in tessuto per effetti di luce diffusa. Struttura in metallo cromato. Per lampade con attacco E27 o equivalenti a LED. Interruttore On/Off sulla base con accensioni separate. Completa di spot 30° orientabile montato su braccetto flessibile equipaggiato con sorgente a LED e driver integrato nel corpo dell'apparecchio.

Wall mounted fixture. Fabric lampshade for diffused light effects. Chromed metal structure. For lamps with E27 socket or LED equivalent. On / Off switch on the base with separate switches. Complete with adjustable 30° spot mounted on a flexible arm equipped with LED source and driver integrated in the body of the device.

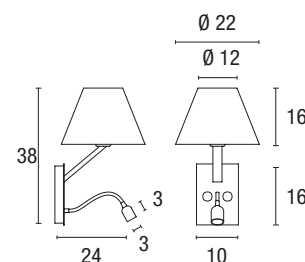

Description	Colour	Power	Source	Socket	Weight	Code
Wall Mounting	Chrome - White	1x max. 15W+1W	FBT E27 / LED	E27+Led	1,3 kg	PAR091

⊕ 220÷240Vac | IP20

Light source E27 not included



TABLE LAMPS

07

I N D E X



Seal_p.374



Sunny_p.376



Smart_p.380



Asia / Asia Mini_p.382



Rex_p.384



Joy_p.386



Sol_p.388



Yab_p.392



Summer_p.394



Mida_p.395



Alter_p.396

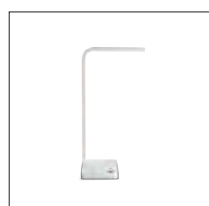

Milla_p.398



Soft_p.399

SEAL

Seal non è soltanto un modello adatto ad illuminare un tavolo nei momenti conviviali ma è un elemento di arredo puntuale che ben si inserisce in interni ed esterni. Il corpo lampada è realizzato in pressofusione di alluminio verniciato su cui è installato il diffusore in policarbonato satinato. La lampada impiega una batteria ricaricabile garanzia di autonomie superiori alle 10 ore di accensione. Il pulsante di accensione permette la regolazione della luminosità con modalità STEPLESS DIMMING ed anche il tono colore 2700-3000 -4000K. In dotazione l'unità di ricarica rapida (220V AC) con cavo USB

Seal is not only a model suitable for illuminating a table during social gatherings, but it is also a punctual decorative element that fits well in both indoor and outdoor settings. The lamp body is made of painted aluminum die-casting, on which the satin-finished polycarbonate diffuser is installed. The lamp utilizes a rechargeable battery, ensuring autonomy of over 10 hours of operation. The power button allows for brightness adjustment with STEPLESS DIMMING mode, as well as color temperature adjustment between 2700-3000-4000K. Is supplied with fast charging unit (220V AC) and USB cable.



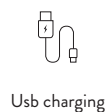
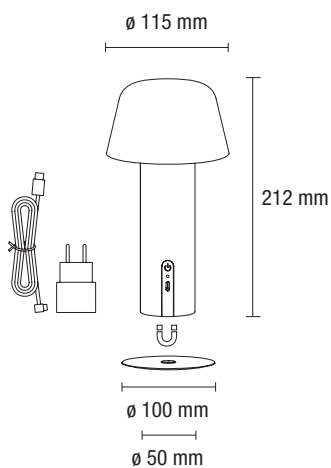

Description	Power	Source	Lumen Output	CCT	CRI	Optic	Weight	Code
White	2 W	SMD Led	180 lm	2200/2700/3000K	>80	Diffuse	0,94 kg	TAV40040
Anthracite	2 W	SMD Led	180 lm	2200/2700/3000K	>80	Diffuse	0,94 kg	TAV40041
Sage Green	2 W	SMD Led	180 lm	2200/2700/3000K	>80	Diffuse	0,94 kg	TAV40042

III 5 V DC | IP54

Autonomia max 10 ore – Tempo di ricarica 5 ore / Work time battery max 10 hours – Recharge 5 hours

Finishes

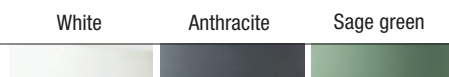

SUNNY





SUNNY



La lampada portatile Sunny è una ricaricabile portatile con diffusore in policarbonato satinato perfetta per giardini, dehors ed ambienti ove si richiede illuminazione puntuale e d'effetto. Ottima l'emissione luminosa che può superare i 240 lumens. Utilizza una batteria ricaricabile che garantisce autonomia superiore alle 6 ore di funzionamento. Il pulsante di accensione permette la regolazione della luminosità con modalità STEPLESS DIMMING con funzione memoria. In dotazione l'unità di ricarica rapida (220V AC) con cavo USB

The Sunny portable lamp is a rechargeable and portable lamp with a satin-finished polycarbonate diffuser, perfect for gardens, outdoor spaces, and environments where precise and impactful lighting is required. It has excellent luminous output that can exceed 240 lumens. It utilizes a rechargeable battery that provides over 6 hours of operating autonomy. The power button allows for brightness adjustment with STEPLESS DIMMING mode and a memory function. Is supplied with fast charging unit (220V AC) and USB cable.

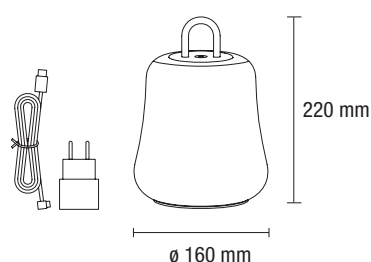

Usb charging

Dimmable
5-100%Work time battery
max 6 hours

Description	Power	Source	Lumen Output	CCT	CRI	Optic	Weight	Code
White	2 W	SMD Led	240 lm	3000K	>80	Diffuse	0,55 kg	GDN05120
Rusty	2 W	SMD Led	240 lm	3000K	>80	Diffuse	0,55 kg	GDN05121
Sage Green	2 W	SMD Led	240 lm	3000K	>80	Diffuse	0,55 kg	GDN05122
Sand	2 W	SMD Led	240 lm	3000K	>80	Diffuse	0,55 kg	GDN05123

III 5 V DC 1A | IP54

Autonomia max 6 ore – Tempo di ricarica 3 ore / Work time battery max 6 hours – Recharge 3 hours

Finishes

White

Rusty

Sage green

Sand



SMART



Lampada da tavolo in metallo verniciato dal design minimalista ed attuale. Ideale completamento di luoghi d'incontro, ambienti interni ed esterni. Viene proposta in 4 colori: bianco, antracite, ruggine e salvia. Il gruppo led da 2.5W 3000K, si alimenta con batteria al litio ricaricabile da 2x 2200 mAh e garantisce accensioni prolungate fino a 12 ore. Pulsante di accensione e regolazione luminosa "soft touch" sulla base. In dotazione una base di ricarica a contatto (220V AC) con cavo USB. Indice di protezione IP54.

Minimalist and contemporary design table lamp. Die casting painted body available in 4 colours: white, anthracite, rust and sage green. Smart is the ideal lighting complement in meeting places, both indoor and outdoor. The 2.5W 3000K led group is powered by a 2x 2200 mAh rechargeable lithium battery and guarantees prolonged switching on up to 12 hours. "Soft touch" on/off and dimming switch on the base. All versions supplied with contact charging base (220V AC) and USB cable. IP54 protection rating for indoor and outdoor use.

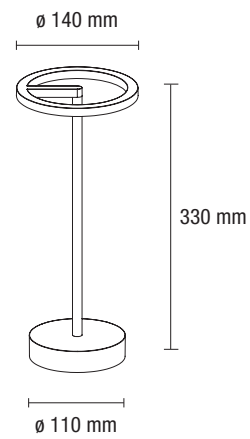

Base di ricarica a contatto
Contact charging base

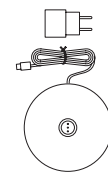

Ø 104 mm

Description	Power	Source	Lumen Output	CCT	CRI	Optic	Weight	Code
White	2,5 W	SMD Led	160 lm	3000K	>80	Diffuse	0,55 kg	TAV40010
Anthracite	2,5 W	SMD Led	160 lm	3000K	>80	Diffuse	0,55 kg	TAV40011
Rusty	2,5 W	SMD Led	160 lm	3000K	>80	Diffuse	0,55 kg	TAV40012
Sage Green	2,5 W	SMD Led	160 lm	3000K	>80	Diffuse	0,55 kg	TAV40013

III 3,7 V DC | IP54

Autonomia max 12 ore – Tempo di ricarica 6-8 ore / Work time battery max 12 hours – Recharge 6-8 hours

Finishes

White

Anthracite

Rusty

Sage green



ASIA & ASIA_Mini

Lampada da tavolo per ambienti esterni ed interni, si inserisce perfettamente in ambienti domestici e nel mondo della ristorazione. Offre un valido comfort visivo con emissione soft e controllata. La struttura è in pressofusione di alluminio verniciato ed usa un diffusore led in policarbonato. L'accensione ha funzione touch dimmer. In dotazione una base di ricarica a contatto (220V AC) con cavo USB.

Table lamp for indoor and outdoor environments, it fits perfectly in domestic settings and in the restaurant industry. It provides reliable visual comfort with soft and controlled lighting. The structure is made of painted aluminum die-casting and uses a polycarbonate LED diffuser. The lamp features a touch dimmer function for turning it on. All versions supplied with contact charging base (220V AC) and USB cable.



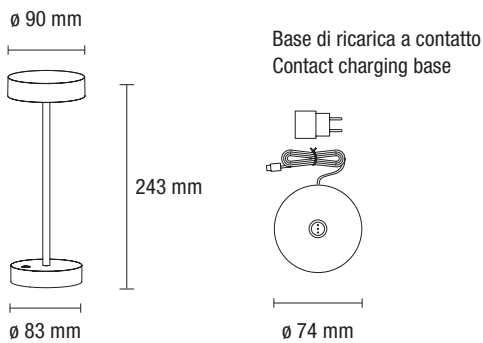

Description	Power	Source	Lumen Output	CCT	CRI	Optic	Weight	Code
White	1,5 W	SMD Led	130 lm	3000K	>80	Diffuse	0,40 kg	TAV40034
Anthracite	1,5 W	SMD Led	130 lm	3000K	>80	Diffuse	0,40 kg	TAV40035
Sage Green	1,5 W	SMD Led	130 lm	3000K	>80	Diffuse	0,40 kg	TAV40036
Sand	1,5 W	SMD Led	130 lm	3000K	>80	Diffuse	0,40 kg	TAV40037

III 3,7 V DC | IP54

Autonomia max 7 ore – Tempo di ricarica 2,5 ore / Work time battery max 7 hours – Recharge 2,5 hours

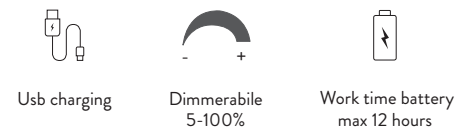
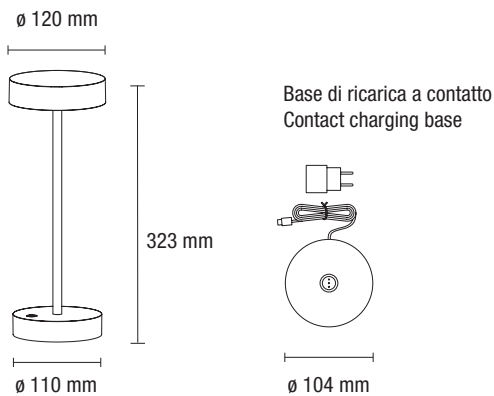

Description	Power	Source	Lumen Output	CCT	CRI	Optic	Weight	Code
White	2,2 W	SMD Led	190 lm	3000K	>80	Diffuse	0,60 kg	TAV40030
Anthracite	2,2 W	SMD Led	190 lm	3000K	>80	Diffuse	0,60 kg	TAV40031
Sage Green	2,2 W	SMD Led	190 lm	3000K	>80	Diffuse	0,60 kg	TAV40032
Sand	2,2 W	SMD Led	190 lm	3000K	>80	Diffuse	0,60 kg	TAV40033

III 3,7 V DC | IP54

Autonomia max 12 ore – Tempo di ricarica 6-8 ore / Work time battery max 12 hours – Recharge 6-8 hours

Finishes

White

Anthracite

Sage green

Sand



REX

Lampada da tavolo dal design trendy e contemporaneo. Si integra perfettamente su tavoli, mensole e piani d'appoggio, sia in interno che in esterno. La struttura è realizzata in metallo verniciato. Il gruppo led da 2W 3000K, si alimenta con batteria al litio ricaricabile da 2600 mAh e garantisce accensioni durevoli nel tempo. Uno schermo in PMMA garantisce l'ottimale distribuzione della luce. Viene proposta in 4 colori: bianco, grigio chiaro, grigio scuro e ruggine. Pulsante di accensione e regolazione luminosa "soft touch" sul riflettore. In dotazione l'unità di ricarica rapida (220V AC) con cavo USB. Indice di protezione IP54.

Trendy and contemporary table lamp which suits perfectly as a piece of furniture on tables, shelves and tops, both indoor and outdoor. Painted metal structure. The 2W 3000K led is powered by a 2600 mAh rechargeable lithium battery and guarantees long lasting lighting performances. PMMA screen guarantees optimal light distribution. It is offered in 4 colours: white, light gray, dark gray and rust. "Soft touch" on/off and dimming switch on the base. Rex is supplied with fast charging unit (220V AC) and USB cable. IP54 protection rating.



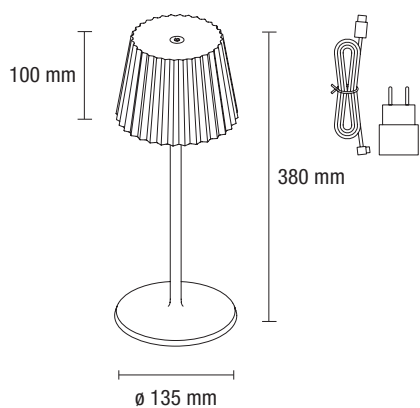

Description	Power	Source	Lumen Output	CCT	CRI	Optic	Weight	Code
White	2 W	SMD Led	190 lm	3000K	>80	Diffuse	1,2 kg	TAV40020
Dark Grey	2 W	SMD Led	190 lm	3000K	>80	Diffuse	1,2 kg	TAV40021
Rusty	2 W	SMD Led	190 lm	3000K	>80	Diffuse	1,2 kg	TAV40022
Light Grey	2 W	SMD Led	190 lm	3000K	>80	Diffuse	1,2 kg	TAV40023

III 5 V DC | IP54

Autonomia max 7 ore – Tempo di ricarica 3 ore / Work time battery max 7 hours – Recharge 3hours

Finishes



JOY

Joy è una lampada da tavolo portatile con batteria ricaricabile; con cavo USB in dotazione. Autonomia massima di circa 9 ore. Si accende con pulsante soft touch inerito nel corpo dell'apparecchio. Joy si adatta ad ambienti interni ed esterni; si può appendere utilizzando il gancio aperto, integrato nel corpo della lampada. La luce di Joy è estremamente confortevole, la sorgente Led è nascosta alla vista e protetta da uno schermo opalino che diffonde gradevolmente la luce. Joy è particolarmente resistente, è realizzata in pressofusione di alluminio verniciato.

Joy is a portable table lamp with a rechargeable battery and a USB cable included. It has a maximum autonomy of approximately 9 hours. It can be turned on using a soft-touch button embedded in the body of the device. Joy is suitable for both indoor and outdoor environments; it can be hung using the integrated open hook in the lamp's body. The light emitted by Joy is extremely comfortable, with the LED source hidden from view and protected by an opaline screen that pleasantly diffuses the light. Joy is particularly durable, as it is made of painted aluminum die-casting.



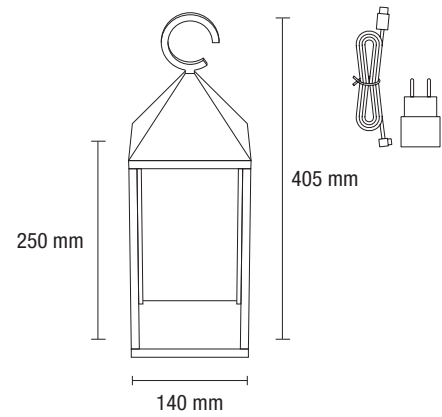

Description	Power	Source	Lumen Output	CCT	CRI	Optic	Weight	Code
White	2,2 W	SMD LED	190 lm	3000K	>80	Diffuse	1,3 kg	GDN05111
Anthracite	2,2 W	SMD LED	190 lm	3000K	>80	Diffuse	1,3 kg	GDN05131

◆ 3,7 V DC | IP54

Autonomia max 9 ore – Tempo di ricarica 7 ore / Work time battery max 9 hours – Recharge 7 hours

Finishes

White

Anthracite



SOL







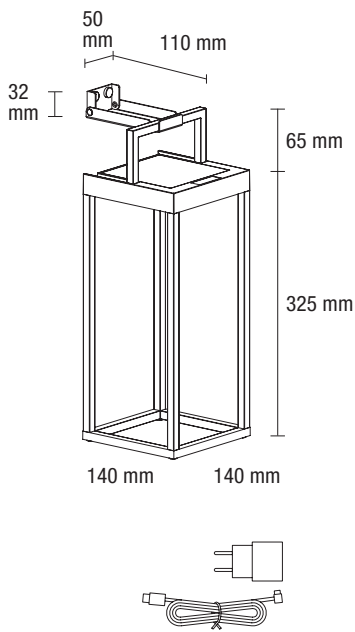

Lampada da tavolo per interni ed esterni con ricarica solare. Struttura in metallo verniciato con polveri epossidiche resistente ad agenti esterni ed UV e diffusore led in policarbonato. Accensione con funzione touch e dimmer per la regolazione luminosa. Apparecchio indipendente ha una gestione eco-friendly se utilizzata con il pannello solare integrato. Garantisce un lungo periodo di accensione ed è fornita con gancio per il fissaggio alla parete.

Table lamp for indoor and outdoor use with solar charging. The structure is made of powder-coated metal, resistant to external agents and UV rays, and features a polycarbonate LED diffuser. It has a touch-sensitive power switch and a dimmer for light adjustment. This independent device has an eco-friendly management when used with the integrated solar panel. It ensures a long period of illumination and is provided with a hook for wall mounting.



Twilight sensor



Solar recharge



Usb charging



Dimmerabile



Charging indicator



Work time battery max 10 hours

Description	Power	Source	Lumen Output	CCT	CRI	Optic	Weight	Code
White	2,5 W	SMD Led	180 lm	3000K	>80	Diffuse	0,97 kg	GDN05115
Anthracite	2,5 W	SMD Led	180 lm	3000K	>80	Diffuse	0,97 kg	GDN05116
Rusty	2,5 W	SMD Led	180 lm	3000K	>80	Diffuse	0,97 kg	GDN05117

III 3.7 V DC | IP54

Autonomia max 10 ore - Tempo di ricarica 11-12 ore luce solare - 6-7 ore ricarica usb
Work time battery max 10 hours - 11-12 hours sunshine - 6-7 hours usb charging

Finishes

White

Anthracite

Rusty



YAB

Yab è una lampada da tavolo “a pantografo” realizzata in alluminio verniciato progettata per l’illuminazione diretta per la scrivania. L’interruttore di accensione sulla testa dell’apparecchio di tipo “soft touch” consente l’accensione e la dimmerazione con una leggera pressione del dito; la sua struttura è caratterizzata dal braccio regolabile bilanciato e dalla testa ottica orientabile. La sorgente LED ad alta efficienza è alimentata dal driver elettronico integrato nell’apparecchio. Cavo di alimentazione in piattina in silicone di colore bianco, lunghezza 200 cm.

Yab is a “pantograph” table lamp made of painted aluminium designed for direct desk lighting. The “soft touch” type on / off switch on the head permits switching and dimming with a light finger pressure; its structure is characterized by the balanced adjustable arm and the adjustable optical head. The high efficiency LED source is powered by the electronic driver integrated in the fixture. White silicone flat power cord, maximum length 200 cm.





	Luminous intensity
1	last level setting
2 +	push
3 -	push
4	off

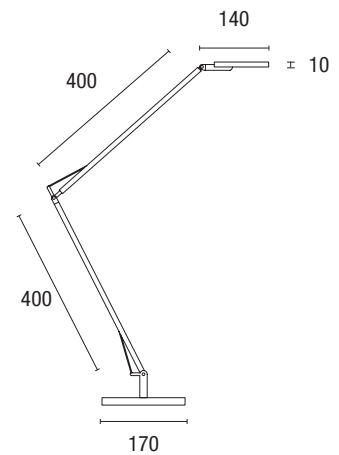

Description	Power	Source	Lumen Output	CCT	Weight	Code
White	8 W	SMD LED	450 lm	3000K	3,2 kg	TAV00068
Black	8 W	SMD LED	450 lm	3000K	3,2 kg	TAV00069

220÷240Vac | IP20

Finishes

White

Black



SUMMER

Con la sua struttura “a pantografo”, Summer è una lampada da tavolo realizzata in metallo cromato e caratterizzata dalla testa semitrasparente. Il suo braccio regolabile è bilanciato dalla testa ottica orientabile. Summer è dotata di attacco E27 e si completa con un cavo di alimentazione di 150 cm. e con un interruttore on/off posizionato dietro la testa.

With its “pantograph” structure, Summer is a table lamp made of chrome metal and characterized by a semi-transparent head. Its adjustable arm is balanced by the adjustable optical head. Summer is equipped with an E27 connection and is completed with a 150 cm power cable and with an on/off switch positioned behind the head.

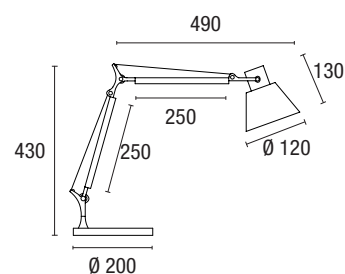

Description	Power	Source	Socket	Weight	Code
Chrome	max. 15 W	LED / FBT	E27	1,7 kg	TAV378

220=240Vac | IP20

Lamp not included

MIDA

Mida è una lampada da tavolo “a pantografo” realizzata in metallo verniciato e completa di testa orientabile a ogiva. Il suo braccio regolabile è bilanciato dalla testa ottica. Mida è dotata di attacco E27 e si completa con un cavo di alimentazione di 150 cm. e con un interruttore on/off posizionato dietro la testa.

Mida is a “pantograph” table lamp made of painted metal and complete with an adjustable ogive head. Its adjustable arm is balanced by the optical head. Mida has an E27 connection and is completed with a 150 cm power cable and with an on/off switch positioned behind the head.

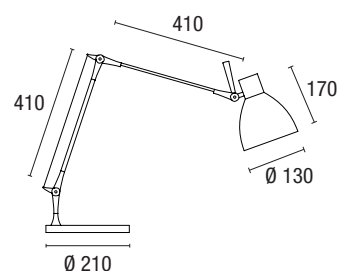

Description	Power	Source	Socket	Weight	Code
Chrome - Aluminum	max. 40 W	LED / FBT	E27	4,0 kg	TAV423

220=240Vac | IP20

Lamp not included

ALTER

Alter è una lampada da tavolo “a pantografo” realizzata in metallo verniciato. Il suo braccio regolabile è bilanciato dalla testa ottica orientabile. Alter illumina la scrivania grazie a un CoB Led alimentato da un driver integrato. Si completa con un cavo di alimentazione in silicone nero di 150 cm. ed un interruttore on/off posizionato sotto la testa del corpo lampada.

Alter is a “pantograph” table lamp made of painted metal. Its adjustable arm is balanced by the adjustable optical head. Alter lights the desk thanks to a CoB Led powered by an integrated driver. It is completed with a 150 cm black silicone power cable, and an on/off switch located under the head of the lamp body.





Description	Power	Source	Lumen Output	Weight	CCT	Code
Black	5 W	CoB LED	410 lm	1,7 kg	4000K	TAV00004
Chrome	5 W	CoB LED	410 lm	1,7 kg	4000K	TAV00005

220÷240Vac | IP20

Finishes

Chrome

Black



MILLA

Milla è una lampada da tavolo dimmerabile realizzata in alluminio verniciato. Il particolare stelo include la sorgente di luce a led, che è completamente nascosta alla vista per evitare qualsiasi forma di abbagliamento diretto. La sorgente LED ad alta efficienza è integrata nell'apparecchio così come il driver elettronico. La sua accensione e regolazione avviene dal pulsante tipo "soft touch" posizionato sulla base. Cavo di alimentazione in piattina in silicone di colore bianco di 200 cm. di lunghezza.

Milla is a dimmable table lamp made of painted aluminium. The particular stem includes the LED light source, which is completely hidden from view to avoid any form of direct glare. The high efficiency LED source is integrated into the fixture as well as the electronic driver. It can be switched on/off and dimmed using the "soft touch" button located on the base. White silicone flat power cord, maximum length 200 cm.

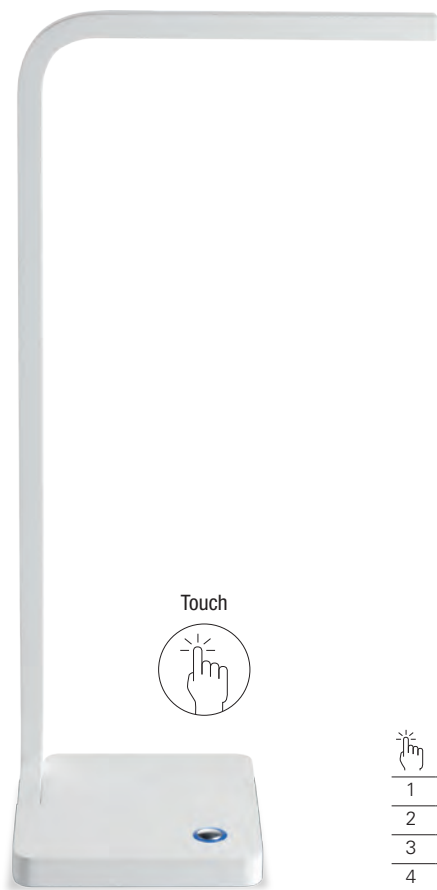

	Luminous intensity
1	low level
2	medium level
3	high level
4	off

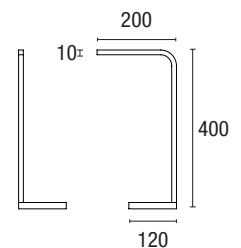

Description	Power	Source	Lumen Output	CCT	Weight	Code
White	5 W	SMD LED	340 lm	3000K	0,7 kg	TAV00040
☐ 220÷240Vac IP20						

Finishes

White



SOFT

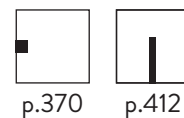

Soft Table è una lampada da tavolo che si abbina in coordinato alle piantane Soft Floor e alla versione da parete Soft Wall. Con astina fissa in metallo, è completa di paralume in tessuto che fornisce un'illuminazione morbida e diffusa. Dotata di attacco E27 si alimenta grazie al cavo PVC trasparente, di lunghezza 180 cm. sul quale si trova l'interruttore on/off.

Soft Table is a table lamp that matches with the Soft Floor and the Soft Wall mounted version. With fixed metal rod, it is complete with fabric lampshade that provides soft and diffused lighting. Equipped with E27 connection, it is powered by the transparent PVC cable, 180 cm long. on which the on/off switch is located.

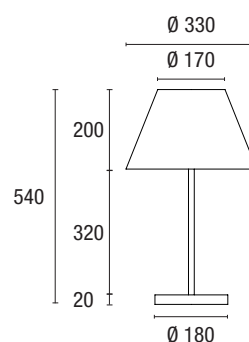

Description	Power	Source	Socket	Weight	Code
Chrome - White	max. 15 W	LED / FBT	E27	2,0 kg	TAV564
<input type="checkbox"/> 220÷240Vac IP20					Lamp not included

Finishes

Chrome





FLOOR LAMPS

08

I N D E X



Maya Mini_p.402



Lunar_p.410



Soft_p.412

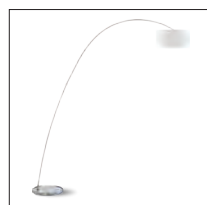

Bow_p.414



Shade_p.416



Maiko_p.418



Zaria_p.420

MAYA_mini Floor



Le lampade da terra occupano uno spazio centrale nel progetto Maya_Mini. Sono due i modelli in gamma, progettati per impieghi diversi tra loro: "Ambient" ed "Office". "Ambient" si rivolge ad utilizzi prettamente domestici o finalità decorative. Si configura in versione monocromatica On/Off. La versione domotica permette la gestione Monocromatica, RGBW e Tunable White e l'utilizzo di voice control associabile ai principali modelli in uso (Google -Alexa). "Office" nasce invece per impieghi specifici e professionali. Si rivolge all'utenza più esigente e qualificata per illuminare e valorizzare desk, piani lavoro ed ambienti operativi in genere. Ottica asimmetrica speciale per l'illuminazione del piano di lavoro. La versione standard ha emissione luce up down dimmerabile separatamente. La versione con sensore di presenza regola in autonomia l'accensione ed il livello di luminosità impostato dall'utente. Ogni apparecchio mantiene gli alti standard qualitativi e tecnici già evidenti nella linea Maya. Vastissima la gamma colori che rappresenta il vero punto di forza della collezione. Un configuratore on line permette la selezione del prodotto desiderato in maniera rapida e semplice.

Floor lamps occupy a central space in the Maya_Mini project. There are two models in the range, designed for different uses: "Ambient" and "Office". "Ambient" is mainly for domestic uses or decorative purposes. It is configured in monochrome version On/Off or home automation version for Monochrome, RGBW and Tunable White. The home automation version allows the use of voice control associated with the main models in use (Google -Alexa). "Office" is designed for specific and professional uses, thus is mainly used for lighting and enhancing desks, worktops and operating environments in general. Special asymmetric optics for illumination of the worktop. The standard version has dimmable up-down light output separately. The version with presence sensor independently adjusts switch_ON and brightness level set by the user. Each device maintains the high quality and technical standards already evident in the Maya line. The wide range of colours represents the true strength of the collection. An online configurator allows the selection of the desired product quickly and easily.



EXTENDED COLLECTION

+ MAYA_mini Ceiling pag 234

+ MAYA_mini Pendant pag 284



+ MAYA_mini Wall/Ceiling pag 340





SENSOR

Il modello "Sensor" associa al dimmer manuale un sensore di presenza e controllo dell'illuminazione in funzione della luce ambiente. Questa versione massimizza l'efficienza energetica secondo gli standard più elevati. L'apparecchio è disponibile in versione monocromatica (2700K - 3000K - 4000K) con schede Led ad alta efficienza (MacAdam) ≤ 3 SDCM.

In addition to the manual dimmer, the "Sensor" model has a presence sensor and a light control system according to ambient light. This version maximizes energy efficiency to the highest standards. The luminaire is available in monochrome version (2700K - 3000K - 4000K) with high efficiency Led (MacAdam) ≤ 3 SDCM.

AMBIENT

La lampada "Ambient" è disponibile in due versioni. Un modello semplice, con interruttore On/Off a pedale per la versione monocromatica. In questa configurazione si può scegliere la temperatura di colore della scheda LED in tre varianti: 2700K-3000K e 4000K.

La versione SMART si può invece configurare in monocromatico (2700K-3000K e 4000K), tunable white e colore RGBW. Questa soluzione, più tecnologica, offre la possibilità di collegamenti alla rete WI-FI ed il software gestisce anche il Voice Control.

The floor lamp "Ambient" is available in two versions. A simple model, with On/Off foot switch for the monochrome version. In this configuration customer can choose one of possible LED board color temperature: 2700K-3000K and 4000K.

The SMART version can be selected in several constructions: monochrome (2700K-3000K and 4000K), tunable white and RGBW color. The domotic solution, more technological, can be connected to the WI-FI network and its software also manages the Voice Control.

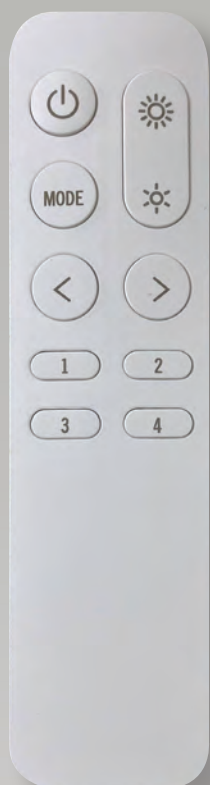

Ha un telecomando in dotazione e permette la gestione voice control (Google-Alexa).

With remote control included and voice control management (Google-Alexa).

Powered by



OFFICE



Connessione angolare: La lampada si caratterizza per un innovativo sistema di connessione angolare che valorizza l'estetica minimale del prodotto.

Angular connection: The lamp is characterized by an innovative angular connection system enhances the minimal aesthetics of the product.



Dimmer: La lampada ha la funzione accensione-dimmer indipendente UP-DOWN. Il pulsante e l'elettronica di controllo sono integrati nella struttura dell'apparecchio.

Dimmer: The lamp has an independent UP-DOWN switch-dimmer function. The button and the electronic controls are integrated into the structure of the fixture.

La lampada è progettata per illuminare un posto di lavoro ed al contempo fornire luce ambiente. Il flusso luminoso diretto verso il basso utilizza un'ottica asimmetrica orizzontale che direziona il flusso sul piano sottostante. Questa soluzione garantisce un comfort visivo ottimale con alta uniformità della luce. La limitazione dell'abbagliamento è conforme alla norma DIN EN 12464-1. Emissione: diretta 30 % - indiretta 70 %. Due le versioni disponibili: Il modello "Smart" ha un dimmer manuale 0/100 inserito nella struttura e permette accensioni indipendenti della luce diretta ed ambiente. È fornita completa di cavo alimentazione 300 cm e spina Schuko.

The lamp is designed to illuminate a workplace and ambient light environment. The downward directed luminous flux uses a horizontal asymmetric optics that directs the flow on the underlying plane. This solution guarantees optimum visual comfort with high light uniformity. The glare limitation complies with DIN EN 12464-1. Emission: direct 30 % - indirect 70 %. Two versions available: The "Smart" model has a 0/100 manual dimmer inserted in the structure and allows independent switching of direct light and environment. 300 cm power cable and Schuko plug included.

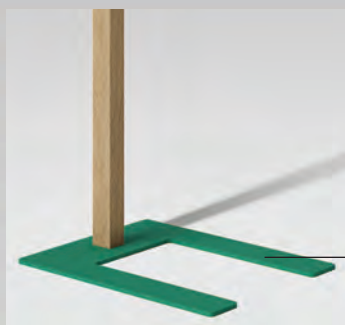

Base: Una base in metallo di 8 Kg garantisce la stabilità ottimale.

Base: A 8 Kg metal base ensures optimal stability.

MAYA_mini Office

Structure

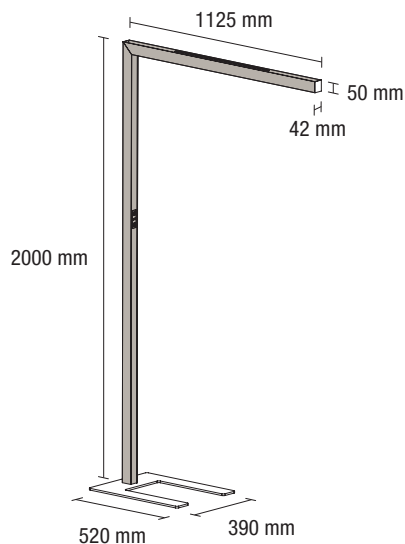

Power	Lumen output		Colour	* code to complete
	downlight	uplight		
48 W	2020 lm	5000 lm	White	MM-EL ■ △ □ WW
			Black	MM-EL ■ △ □ BB
			Lunar Grey	MM-EL ■ △ □ GG
			Tobacco	MM-EL ■ △ □ OO
			Old Zebra	MM-EL ■ △ □ MM
			Green Grass	MM-EL ■ △ □ NN
			Oman Red	MM-EL ■ △ □ PP
			Desert Camouflage	MM-EL ■ △ □ QQ
			Beech Wood	MM-EL ■ △ □ HH
			Oak Wood	MM-EL ■ △ □ II
			Walnut Wood	MM-EL ■ △ □ LL
			Antique Marble	MM-EL ■ △ □ SS
			Concrete	MM-EL ■ △ □ TT

⊕ 220÷240Vac | IP40

UP to 146 lm/W | UGR≥19 | L80/B20 80.000 h. | CRI>90 | RG1 | SDCM<3
Lumen output values: luminaire luminous flux at 4000 K

Base + end cap

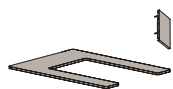

Colour	code
White	MM-ENWW
Black	MM-ENBB
Sand	MM-ENVV
Tobacco	MM-ENOO
Gray	MM-ENGG
Sage Green	MM-ENUU
Orange Fluo	MM-ENAA



Optical Info p. 528

* Select your option

CCT	Optic	Control
2700 K 1	Asy Office White R	Dimm DA
3000 K 2	Asy Office Black S	Dimm with sensor DS
4000 K 3		

MAYA_mini Ambient

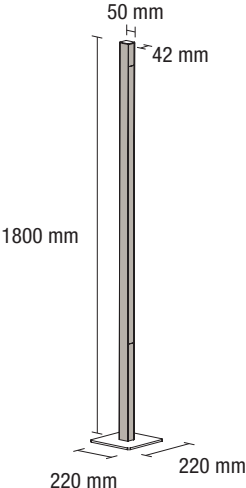
Structure

	Power	Lumen output	Colour	* code to complete
	33 W	1960 lm	White	MM-E0 ■ □ WW
			Black	MM-E0 ■ □ BB
			Lunar Grey	MM-E0 ■ □ GG
			Tobacco	MM-E0 ■ □ OO
			Old Zebra	MM-E0 ■ □ MM
			Green Grass	MM-E0 ■ □ NN
			Oman Red	MM-E0 ■ □ PP
			Desert Camouflage	MM-E0 ■ □ QQ
			Beech Wood	MM-E0 ■ □ HH
			Oak Wood	MM-E0 ■ □ II
			Walnut Wood	MM-E0 ■ □ LL
			Antique Marble	MM-E0 ■ □ SS
			Concrete	MM-E0 ■ □ TT
			 220÷240Vac IP40	UP to 60 lm/W opal diffuser L70/B50 > 36.000 h. CRI>90 RG0 Lumen output values: luminaire luminous flux at 4000 K

Base + end cap



Colour	code
White	MM-EPWW
Black	MM-EPBB
Sand	MM-EPVV
Tobacco	MM-EPOO
Gray	MM-EPGG
Sage Green	MM-EPUU
Orange Fluo	MM-EPAА

Optical Info p. 528

* Select your option

CCT		Control	
2700 K	1	On/Off	NF
3000 K	2	Voice Control Tuya + RF	TU
4000 K	3		
Tunable	4		
RGBW	5		

LUNAR



p.302

Lunar Floor è una piantana dimmerabile realizzata in metallo verniciato. Si caratterizza per il suo schermo diffondente PMMA che ruota su sé stesso e permette di illuminare gli ambienti con una luce gradevolmente diffusa. Lunar Floor è dotata di sorgente LED ad alta efficienza e di driver elettronico integrato nell'apparecchio ed è completa di cavo alimentazione in PVC bianco o grigio; il cavo di alimentazione include il dimmer a pedale ed è lungo 180 cm.

Lunar Floor is a dimmable floor lamp made of painted metal. It is characterized by its PMMA diffusing screen that rotates on itself and allows to illuminate the rooms with a pleasantly diffused light. Lunar Floor is equipped with a high efficiency LED source and an electronic driver integrated in the luminaire and is complete with a white or gray PVC power cable; the power cable includes the pedal dimmer and is 180 cm long.



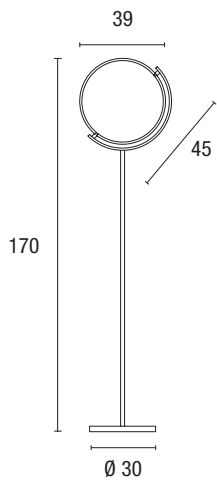

Optical Info p. 536

Description	Power	Source	Lumen Output	CCT	Weight	Code
White	20 W	SMD LED	1910 lm	3000K	7,7 kg	TER00039
Black	20 W	SMD LED	1910 lm	3000K	7,7 kg	TER00040

☐ 220÷240Vac | IP20

Flusso luminoso emesso: semi-diretto; frontale 90% retro 10% / Luminous flux output: semi-direct; front 90% back 10%

Finishes

White

Black



SOFT

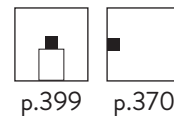

Soft Floor è una lampada da terra con struttura in metallo in metallo cromato. Mantiene un design classico ed utilizza un paralume in tessuto lino colore bianco. Soft Floor si caratterizza per la luce morbida e confortevole, perfettamente diffusa sia sul paralume che nell'ambiente circostante. L'interruttore ON-OFF è posizionato sulla base metallica che ne garantisce buona stabilità.

Soft Floor is a floor lamp with chrome metal structure. It maintains a classic design and uses a lampshade in white linen fabric. Soft Floor is characterized by the soft and comfortable light, perfectly diffused both on the lampshade and in the surrounding environment. The ON-OFF switch is positioned on the metal base that guarantees good stability



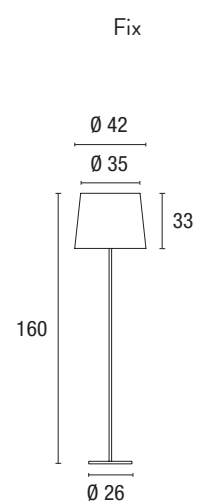

Description	Colour	Power	Source	Socket	Weight	Code
Fix	Chrome - White	1x max. 20 W	LED / FBT	E27	4,2 kg	TER00027
<input type="checkbox"/> 220÷240Vac IP20						Lamp not included

BOW



Bow è una lampada da terra che si distingue per il grande arco; si appoggia a terra grazie alla sua base in metallo assicurandone la stabilità e aggetta un paralume in tessuto che diffonde la luce in modo perfettamente uniforme nell'ambiente. Particolarmente indicata per arredare grandi spazi domestici, è completa di attacco E27 si alimenta tramite il cavo in PVC dotato di interruttore a pedale on/off.

Bow is a floor lamp that stands out for its large arch; equipped with metal base and projecting fabric lampshade that diffuses the light perfectly evenly into the environment. Particularly suitable for furnishing large domestic spaces, it is complete with E27 socket and is powered by the PVC cable equipped with an on/off footswitch.

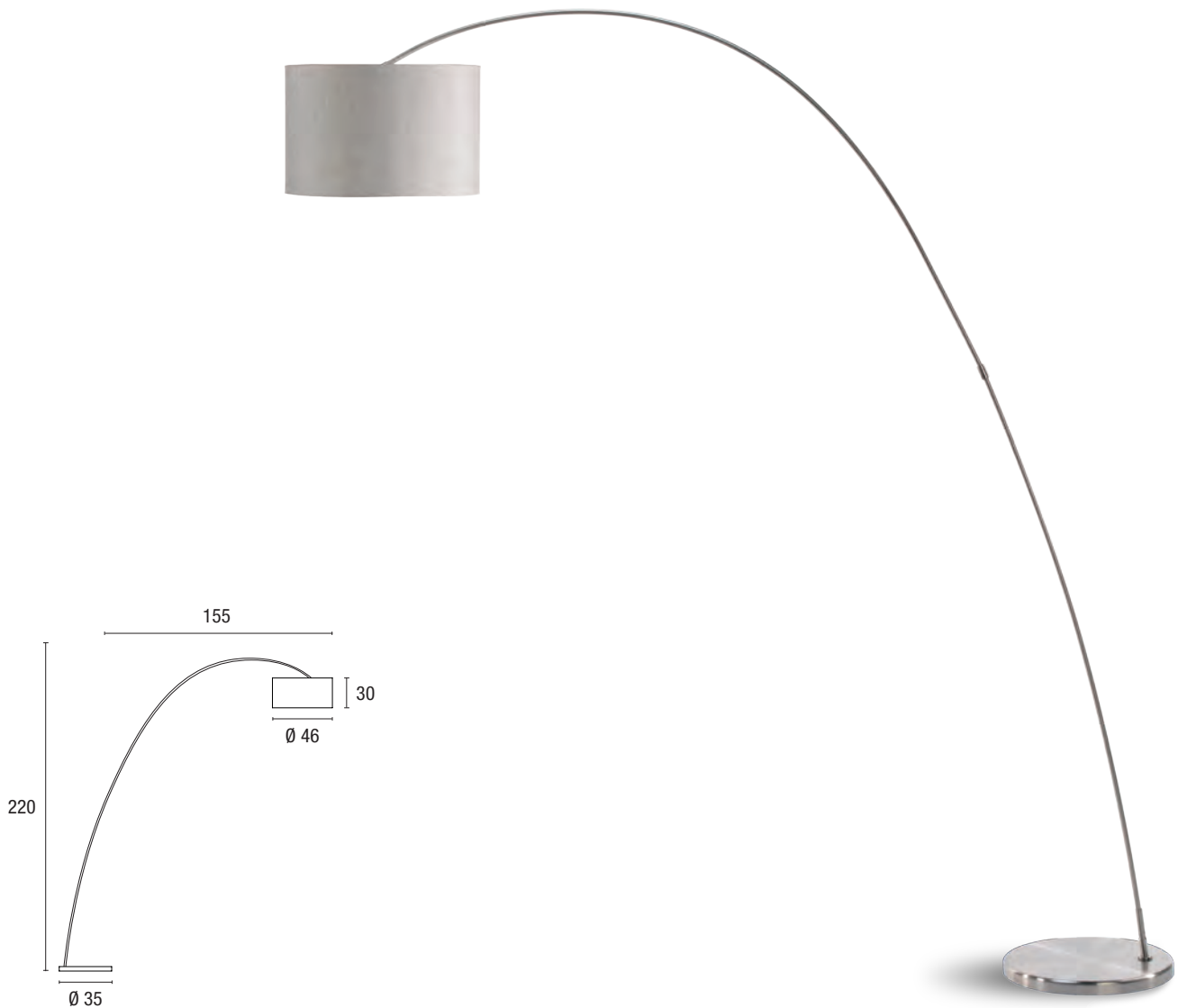

Description	Power	Source	Socket	Weight	Code
Steel - Linen	1x max. 25 W	LED / FBT	E27	11,0 kg	TER095
Black - Black	1x max. 25 W	LED / FBT	E27	11,0 kg	TER098

220÷240Vac | IP20

Lamp not included

Lampshade finish

Linen

Black



SHADE

Shade è una lampada da terra che si caratterizza per la possibilità di regolare l'altezza del paralume; questo scorre lungo l'asta e si blocca grazie ad una ghiera posta dietro l'asta stessa. Il paralume è disponibile in diverse finiture ed è realizzato o in tessuto o in ecopelle. L'asta e la base sono realizzate in legno naturale. Completa di attacco E27, Shade è la piantana ideale per effetti di luce diffusa. Completa di cavo di alimentazione rivestito in tessuto retinato marrone e bianco, di lunghezza massima 200 cm. e dotato di interruttore a pedale on/off.

Shade is a floor lamp which is characterized by the possibility of adjusting the height of the lampshade; this slides along the rod and locks thanks to a ring placed on the rod itself. The lampshade is available in different finishes and is made of either fabric or eco-leather. The rod and base are made of natural wood. Complete with E27 fitting, Shade is the ideal floor lamp for diffused light effects. Complete with power cable covered in brown and white mesh fabric, maximum length 200 cm. and equipped with on / off foot switch.



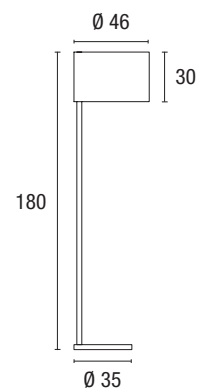

Description	Power	Source	Socket	Weight	Code
Wood - Linen	1x max. 25 W	LED / FBT	E27	8 kg	TER40001
Wood - Bordeaux	1x max. 25 W	LED / FBT	E27	8 kg	TER40002
Wood - Grey Orange	1x max. 25 W	LED / FBT	E27	8 kg	TER40003
Wood - Black Net	1x max. 25 W	LED / FBT	E27	8 kg	TER40004
Wood - Leather	1x max. 25 W	LED / FBT	E27	8 kg	TER40005

220÷240Vac | IP20

Lamp not included

Lampshade finish

Linen

Bordeaux

Grey - Orange

Black Net

Leather



MAIKO

Maiko è una lampada da terra completa di paralume in tessuto o in ecopelle. La struttura è realizzata in legno naturale. È completa di attacco E27 e permette di illuminare gli ambienti con una luce morbidamente diffusa. Il cavo di alimentazione è rivestito in tessuto retinato di colore marrone e bianco, lunghezza massima 200 cm. ed è completo di interruttore a pedale on/off.

Maiko is a floor lamp complete with lampshade in fabric or eco-leather. The structure is made of natural wood. It is complete with E27 fitting and allows you to illuminate rooms with softly diffused light. The power cable is covered in brown and white mesh fabric, maximum length 200 cm. and is complete with on/off footswitch.

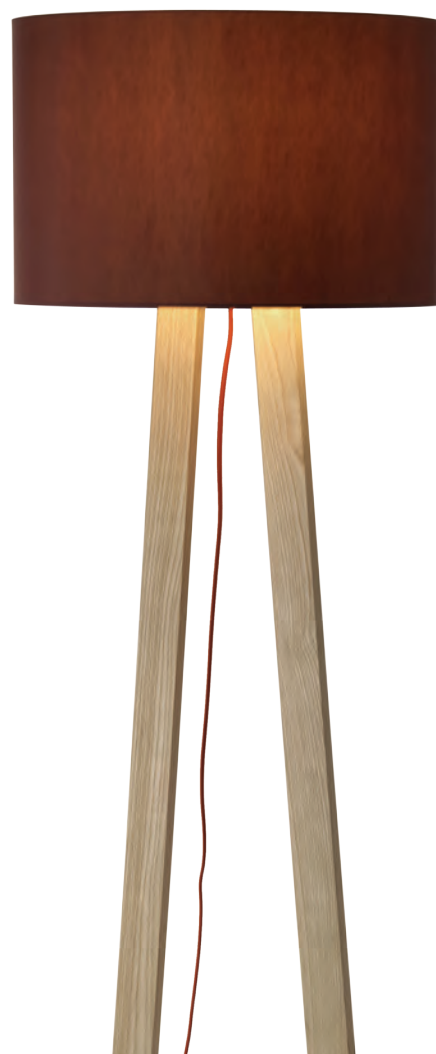

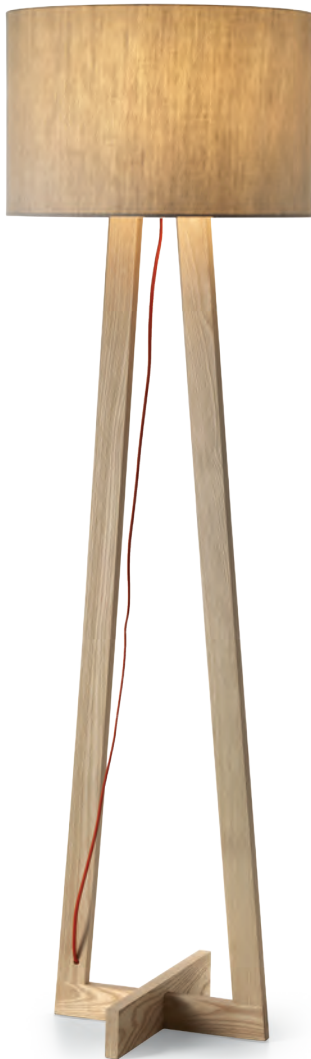

Paralume conico
Conical lampshade

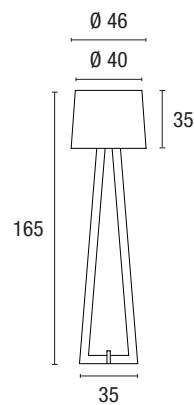

Paralume cilindrico
Cylindrical lampshade

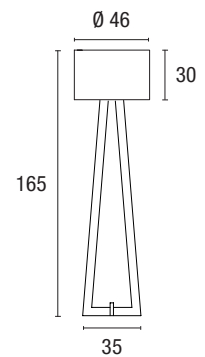

Description	Colour	Power	Source	Socket	Weight	Code
Conical lampshade	Wood / Classic White	1x max. 25 W	LED / FBT	E27	6 kg	TER067
Cylindrical lampshade	Wood / Linen	1x max. 25 W	LED / FBT	E27	6 kg	TER40010
Cylindrical lampshade	Wood / Bordeaux	1x max. 25 W	LED / FBT	E27	6 kg	TER40011
Cylindrical lampshade	Wood / Grey Orange	1x max. 25 W	LED / FBT	E27	6 kg	TER40012
Cylindrical lampshade	Wood / Black Net	1x max. 25 W	LED / FBT	E27	6 kg	TER40013
Cylindrical lampshade	Wood / Leather	1x max. 25 W	LED / FBT	E27	6 kg	TER40014

☐ 220÷240Vac | IP20

Lamp not included

Lampshade finish

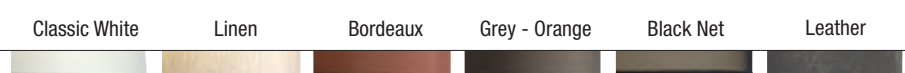

ZAIRA

Zaria è una lampada da terra completa di paralume in tessuto o in ecopelle. La sua struttura è realizzata in legno e si caratterizza per la particolare struttura a tripode. È completa di attacco E27 e permette di illuminare gli ambienti con una luce morbidamente diffusa. Il cavo di alimentazione è rivestito in tessuto retinato di colore marrone e bianco, lunghezza massima 200 cm. ed è completo di interruttore a pedale on/off.

Maiko is a floor lamp complete with lampshade in fabric or eco-leather. Its structure is made of wood and is characterized by the peculiar tripod system. It is complete with E27 fitting and allows you to illuminate rooms with softly diffused light. The power cable is covered in brown and white mesh fabric, maximum length 200 cm. and is complete with on/off footswitch.



Paralume conico
Conical lampshade

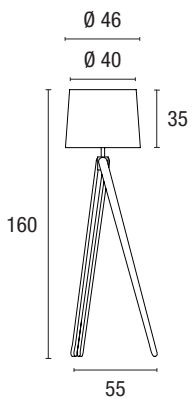

Paralume cilindrico
Cylindrical lampshade

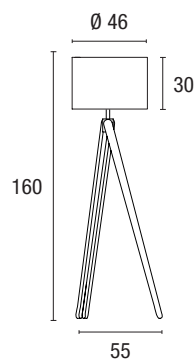

Description	Colour	Power	Source	Socket	Weight	Code
Conical lampshade	Wood / Classic White	1x max. 25 W	LED / IAA	E27	5,2 kg	TER068
Cylindrical lampshade	Wood / Linen	1x max. 25 W	LED / IAA	E27	5,2 kg	TER40020
Cylindrical lampshade	Wood / Bordeaux	1x max. 25 W	LED / IAA	E27	5,2 kg	TER40021
Cylindrical lampshade	Wood / Grey Orange	1x max. 25 W	LED / IAA	E27	5,2 kg	TER40022
Cylindrical lampshade	Wood / Black Net	1x max. 25 W	LED / IAA	E27	5,2 kg	TER40023
Cylindrical lampshade	Wood / Leather	1x max. 25 W	LED / IAA	E27	5,2 kg	TER40024

☐ 220÷240Vac | IP20

Lamp not included

Lampshade finish

Classic White

Linen

Bordeaux

Grey - Orange

Black Net

Leather





INDUSTRIALS

09

I N D E X



Puck Extra_p.424



Beam_p.426

PUCK_Extra



 Pf > 0,95
  IP65
  IK08
 130 lm/W
 L70 / B20 50.000h.
 3 YEARS WARRANTY

La serie PUCK EXTRA è indicata per l'illuminazione indoor dei magazzini e delle aree di produzione, la serie EXTRA, rappresenta evoluzione e sintesi delle esperienze maturate. L'apparecchio, leggero e compatto, monta LED SMD e lenti ottiche secondarie (60° e 90°) che sfruttano al meglio i considerevoli flussi luminosi. Disponibile in 3 potenze (100W - 150W - 200W) garantisce rendimenti lm/W ai vertici di categoria. L'Emissione è diretta rotosimmetrica per un perfetto controllo della luce. Il corpo dell'apparecchio è realizzato in pressofusione di alluminio verniciato per l'ottimizzazione della dissipazione termica. Si installa a sospensione con cavo o catena (non inclusi)

PUCK EXTRA range is designed for warehouses and production areas lighting, these models represents evolution and synthesis of experiences gained. The light and compact luminaire is equipped with SMD LEDs and secondary optical lenses (60° and 90°) that maximize the high flux. 3 powers available (100W - 150W - 200W) guarantees lm/W yields at the top of the category. The Emission is direct rotosymmetric for perfect light control. The body of the luminaire is made of die-cast painted aluminum for the optimization of thermal dissipation. Can be mounted with cable or chain (not included)

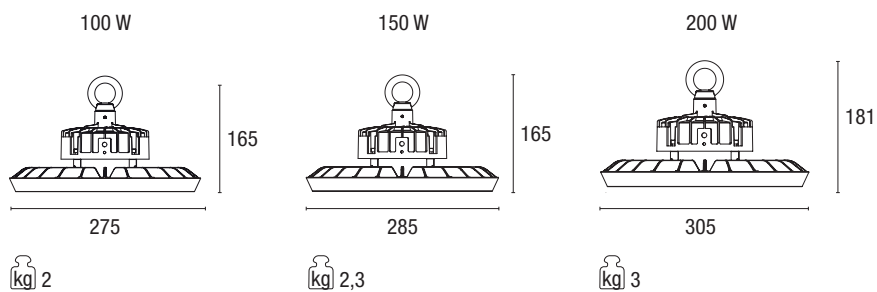

Puck_Extra

Optical Info p. 530

Size	version	CCT	power	optic	code	lumen output	CRI	UGR	power feed
ø 275 mm	On / Off	4000 K	100 W	60°	IND01030	13813 lm	≥ 80	≤ 22	220-240V
				90°	IND01031	13255 lm	≥ 80	≤ 25	220-240V
ø 285 mm	On / Off	4000 K	150 W	60°	IND01032	19334 lm	≥ 80	≤ 22	220-240V
				90°	IND01033	18834 lm	≥ 80	≤ 25	220-240V
ø 305 mm	On / Off	4000 K	200 W	60°	IND01034	25997 lm	≥ 80	≤ 22	220-240V
				90°	IND01035	25202 lm	≥ 80	≤ 25	220-240V

BEAM

⊕ 220÷240 V pf > 0,92 SMD Led IP66 5 YEARS WARRANTY

La serie Beam è composta da moduli per luce proiettata, particolarmente indicati per l'illuminazione delle aree industriali in outdoor e dei campi sportivi in esterni. I moduli ottici, tutti realizzati in estrusione di alluminio per migliorare la dissipazione del calore, mantengono la temperatura di esercizio a livelli ottimali e assicurano nel tempo la durata dei led. Driver e led sono opportunamente selezionati fra la componentistica elettronica "prime label". I moduli ottici, disponibili in due lunghezze, sono tra loro modulari ed equipaggiabili con diverse lenti ottiche in modo da ottenere emissioni luminose ed effetti di luce adatti all'attività da illuminare. Driver e led sono opportunamente selezionati fra la componentistica elettronica "prime label". Completano gli apparecchi le staffe di fissaggio in acciaio, orientabili e regolabili per l'installazione a soffitto, a muro e su testa palo (l'accessorio di fissaggio su testa palo non è incluso).



100 W

lunghezza del modulo <i>module length</i>	2x 275 mm
flusso effettivo <i>light output</i>	13.000 lm
efficacia <i>efficacy</i>	130 lm/W
driver brand <i>driver brand</i>	Philips
led brand <i>led brand</i>	Philips
garanzia <i>warranty</i>	5 anni / 5 years



150 W

lunghezza del modulo <i>module length</i>	3x 275 mm
flusso effettivo <i>light output</i>	19.500 lm
efficacia <i>efficacy</i>	130 lm/W
driver brand <i>driver brand</i>	Philips
led brand <i>led brand</i>	Philips
garanzia <i>warranty</i>	5 anni / 5 years

The Beam series is composed by modules for projected light, particularly suitable for industrial outdoor areas and outdoor sports fields. All the optical modules are made in extruded aluminum to improve heat dissipation, keep the operating temperature at optimal levels and to ensure the lifetime of the LEDs. Drivers and LEDs are properly selected among “prime label” electronic components. The optical modules, available in two lengths, are modular and can be equipped with different optical lenses in order to obtain light emissions and light effects in accordance with the specific activity to light. Adjustable steel fixing brackets for ceiling, wall and pole mounting (the pole fixing accessory is not included) complete this series.



200 W

2x 544 mm

26.000 lm

130 lm/W

Philips

Philips

5 anni / 5 years



300 W

3x 544 mm

39.000 lm

130 lm/W

Philips

Philips

5 anni / 5 years



Dimensioni / Dimensions

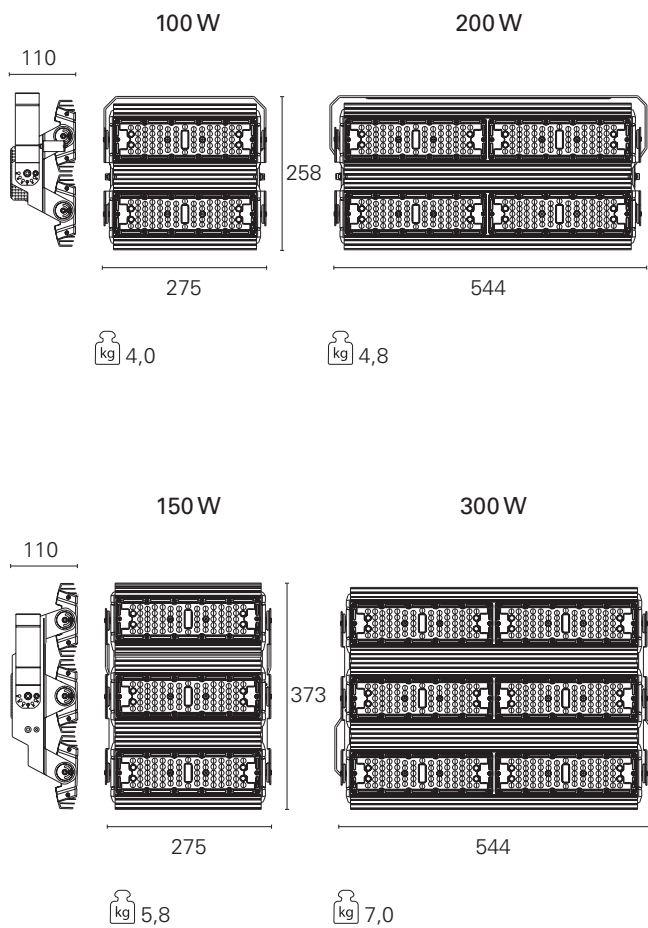

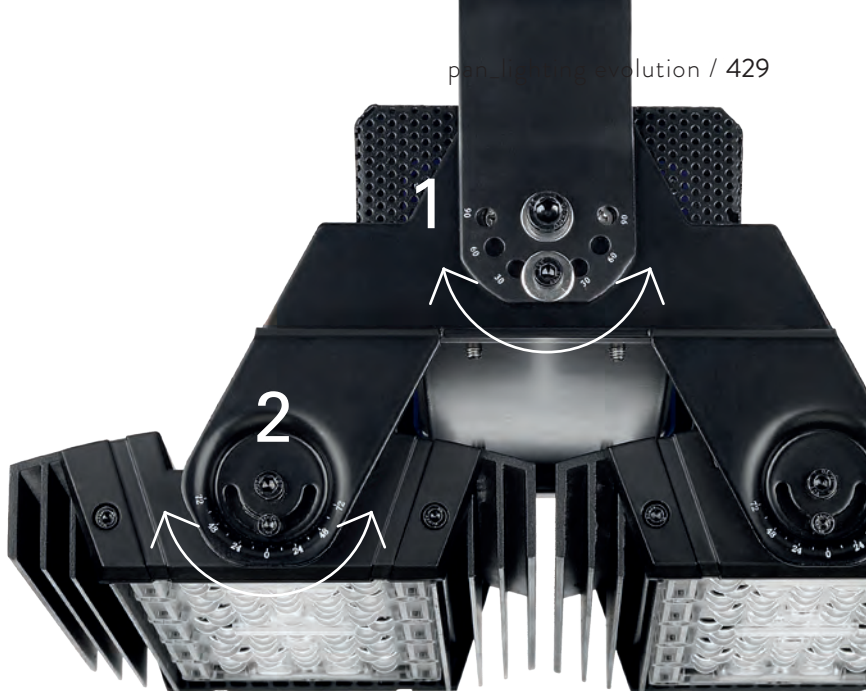

- 1 Orientabilità apparecchio -90° / +90°.
 Blocco dell'orientabilità con brugola su foratura per steps di 30°.
 Ideale per garantire il mantenimento della posizione orientata nel tempo.

*Adjustable product -90° / +90°.
 Locking of the orientation with Allen key on drilling every 30 ° steps Ideal to ensure the maintenance of the oriented position over time.*

- 2 Orientabilità modulo ottico -90° / +90°.
 Blocco del puntamento verticale con vite a brugola su asola continua -45° / +45°, per permettere il puntamento di precisione e garantire la sua affidabilità nel tempo.

*-90° / +90° adjustability optical module
 Block of the vertical aiming with socket head screw on a continuous slot to allow the pointing accuracy and ensure its reliability over time*

Beam Program

Optical Info p. 530

220÷240 V

modello type	potenza power	sorgente source	codice code	flusso apparecchio light output	CCT CCT	CRI CRI	ottica optic	IP IP	IK IK	colore color
Floodlight	2x 50 W	SMD Led	IND06001	13000 lm	5000 K	\	60°	IP66	IK10	nero / black
			IND06002	13000 lm	5000 K	\	90°	IP66	IK10	nero / black
			IND06003	13000 lm	5000 K	\	Elliptical	IP66	IK10	nero / black
			IND06004	13000 lm	5000 K	\	Asymmetric	IP66	IK10	nero / black
	3x 50 W	SMD Led	IND06005	19500 lm	5000 K	\	60°	IP66	IK10	nero / black
			IND06006	19500 lm	5000 K	\	90°	IP66	IK10	nero / black
			IND06007	19500 lm	5000 K	\	Elliptical	IP66	IK10	nero / black
			IND06008	19500 lm	5000 K	\	Asymmetric	IP66	IK10	nero / black
	4x 50 W	SMD Led	IND06009	26000 lm	5000 K	\	60°	IP66	IK10	nero / black
			IND06010	26000 lm	5000 K	\	90°	IP66	IK10	nero / black
			IND06011	26000 lm	5000 K	\	Elliptical	IP66	IK10	nero / black
			IND06012	26000 lm	5000 K	\	Asymmetric	IP66	IK10	nero / black
	6x 50 W	SMD Led	IND06013	39000 lm	5000 K	\	60°	IP66	IK10	nero / black
			IND06014	39000 lm	5000 K	\	90°	IP66	IK10	nero / black
			IND06015	39000 lm	5000 K	\	Elliptical	IP66	IK10	nero / black
			IND06016	39000 lm	5000 K	\	Asymmetric	IP66	IK10	nero / black



PROFILES

10

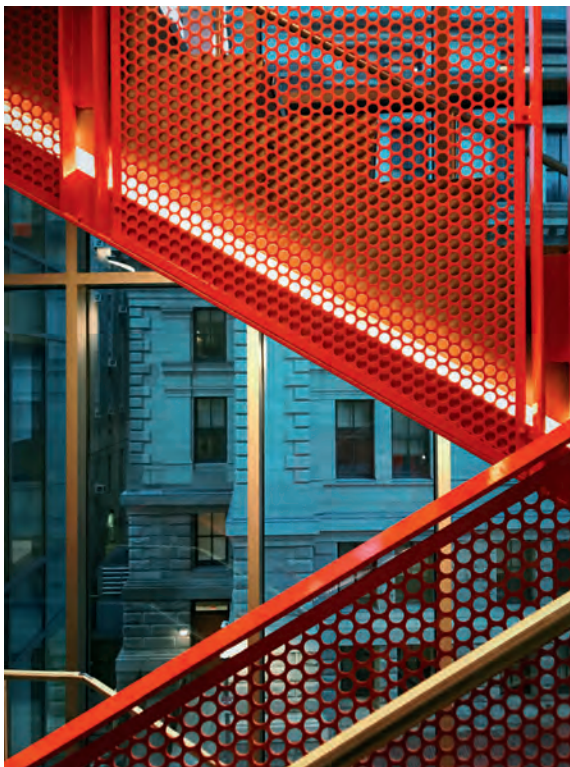

PROFILES

SISTEMI LUMINOSI LINEARI LINEAR LIGHT SYSTEM

Nel panorama dell'illuminazione contemporanea i sistemi luminosi lineari occupano spazi sempre più ampi. Essi contribuiscono alla creazione di effetti e soluzioni tecnicamente inimmaginabili nel recente passato. Punto primario della svolta tecnologica sono le strip led di ultima generazione, veri e propri sistemi d'illuminazione che, a costi ragionevoli, garantiscono prestazioni d'eccellenza, qualità luminose di ottimo livello, efficacia e rese cromatiche equiparabili ai migliori standard. La gamma Profili coniuga diverse peculiarità utili a progettisti ed illuminotecnici, garantendo sempre elevatissimi standard qualitativi. Una scelta diversificata per potenze, efficienza, rese cromatiche e soprattutto impieghi. Un costante ed attento controllo qualitativo rende le strip presenti a catalogo la scelta ideale in ogni applicazione con emissione diretta oppure indiretta.

In the contemporary lighting, linear lighting systems occupy increasingly large spaces. They contribute to the creation of technically unimaginable effects and solutions in the recent past. Primary point of the technological breakthrough are the latest generation of the strip LEDs, lighting systems that, at reasonable costs, guarantee excellent performance, excellent quality of light, efficacy and color rendering comparable to the best standards. The Profili range combines different features useful to designers and lighting technicians, always guaranteeing extremely high quality standards. A diversified choice in terms of power, efficiency, color rendering and above all applications. A constant and careful quality control makes the strips in the catalog the ideal choice in any application with direct or indirect emission.

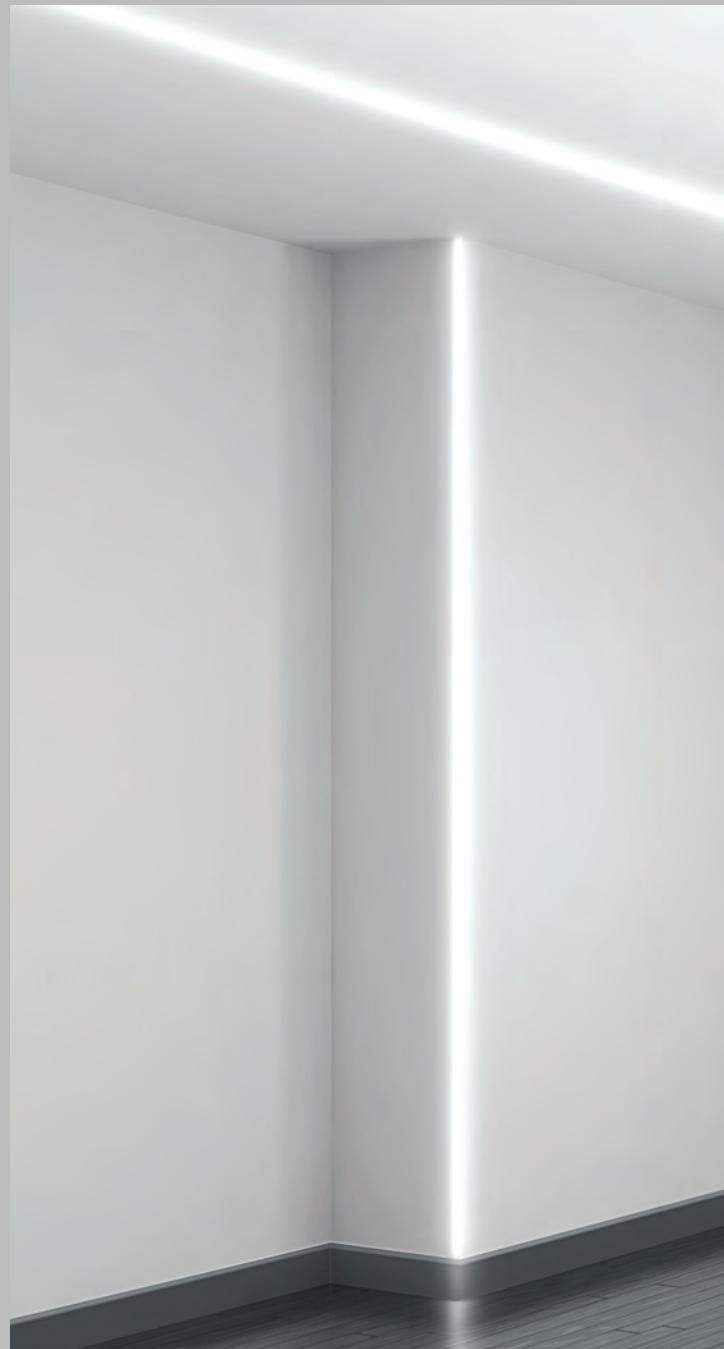



Diffusore Opale
Opal diffuser



Diffusore nero
Black diffuser



Diffusore trasparente
Transparent diffuser

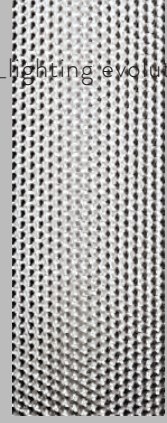

Diffusore Microprismatico
Micro Prismatic diffuser



Schermi con diverse finiture ed opacità consentono varietà d'installazione e corretta gestione dei flussi luminosi. Lo schermo nero è perfetto se associato ad un profilo dello stesso colore. Schermi trasparenti oppure prismatici si impiegano per massimizzare l'emissione o per installazioni più tecniche.

Screens with different finishes and opacities allow variety of installation for the correct management of the lumen flux. Black screen is perfect when associated with profile of the same color. Transparent or prismatic shades are used to maximize the emission or technical installation.

OVERVIEW Scale 1:1

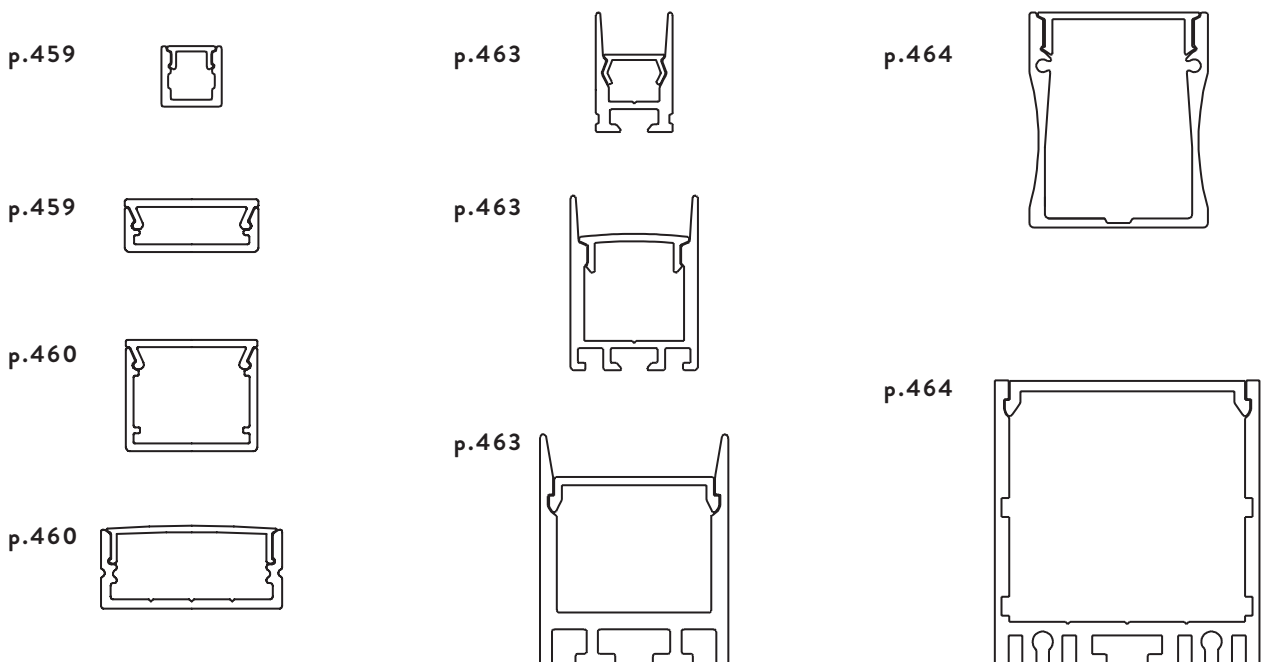
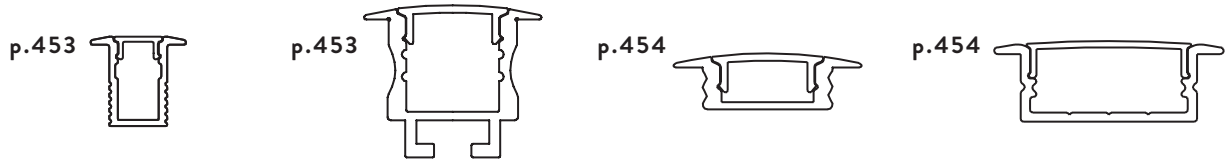
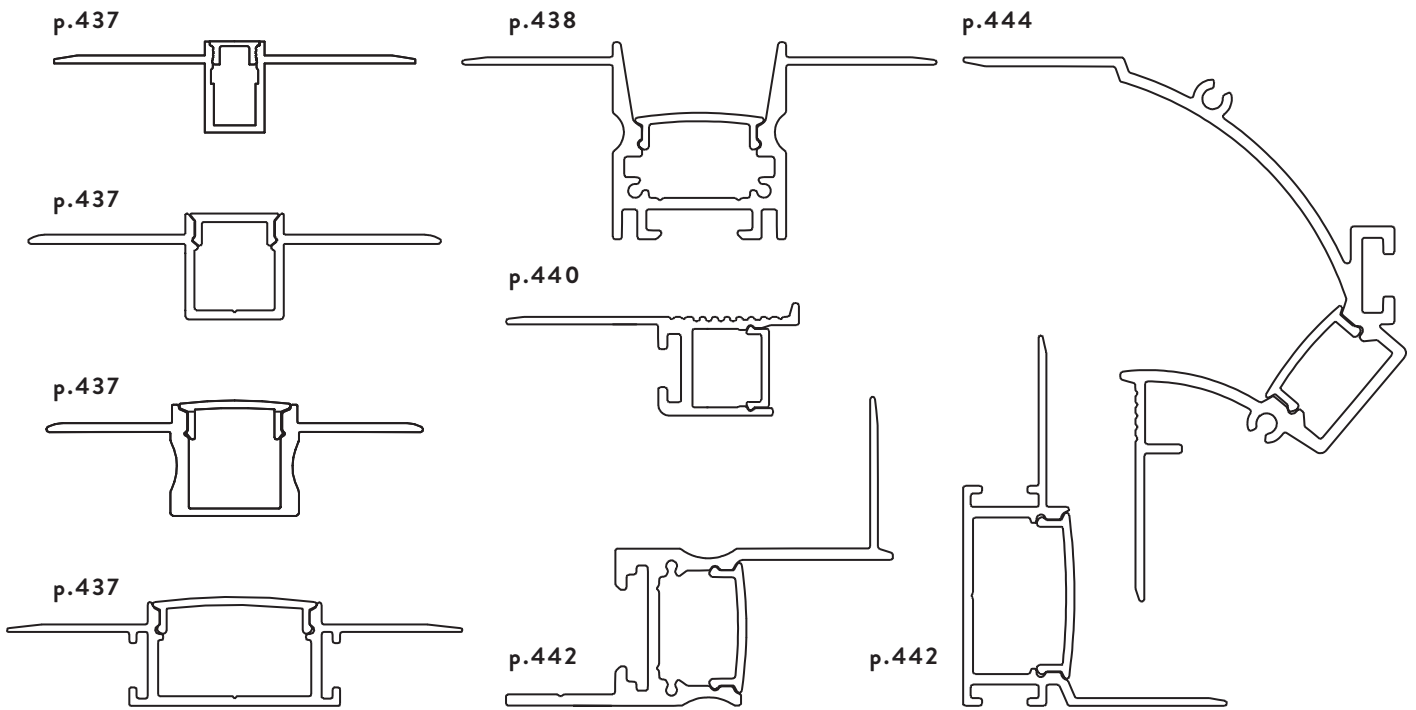

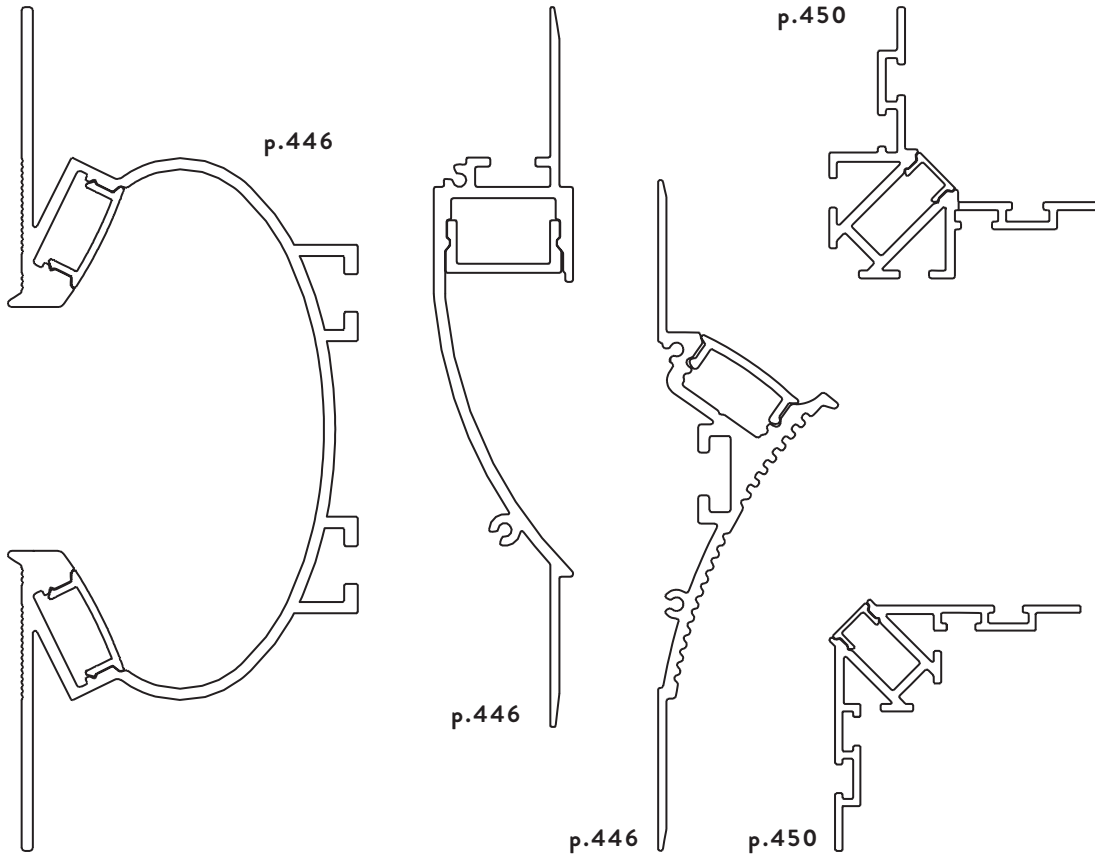

Plasterboard
recessed
436

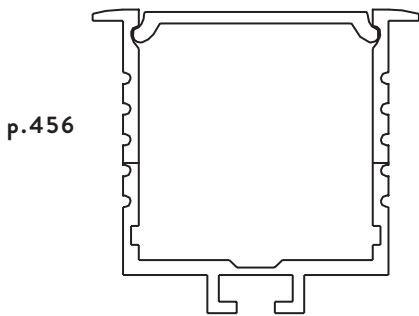

Recessed
452

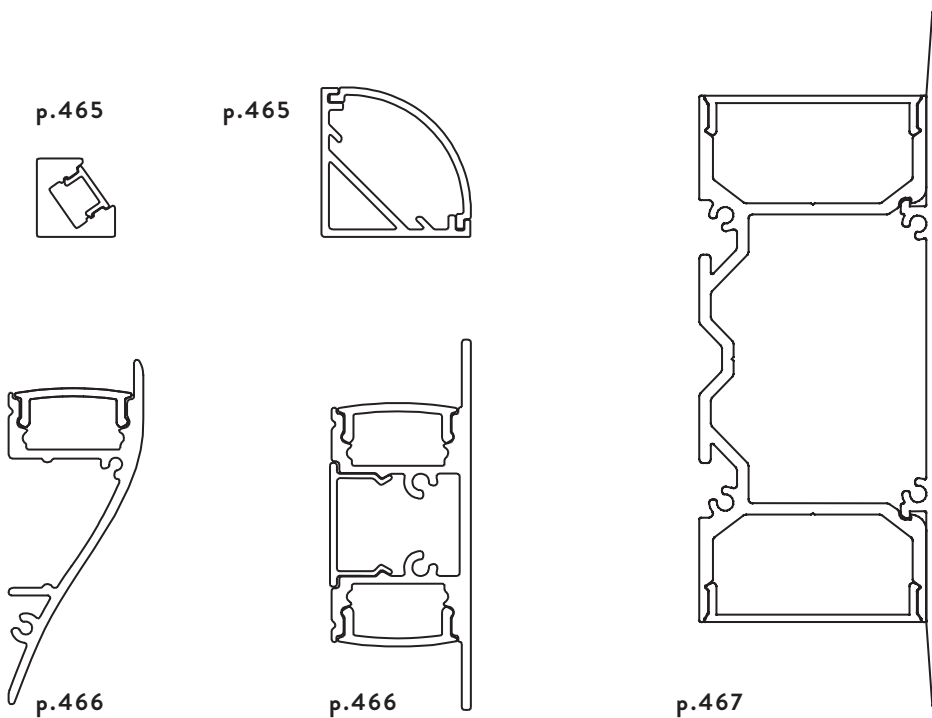

Surface
mounted
458

PLASTERBOARD_RECESSED



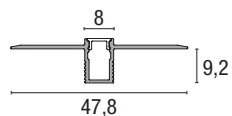

Strip led Max: L 5; H 10

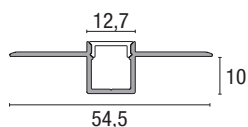
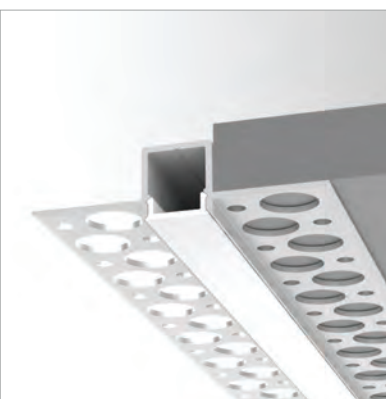

Strip led Max: L 10; H 12

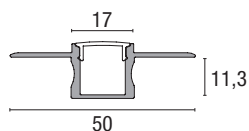
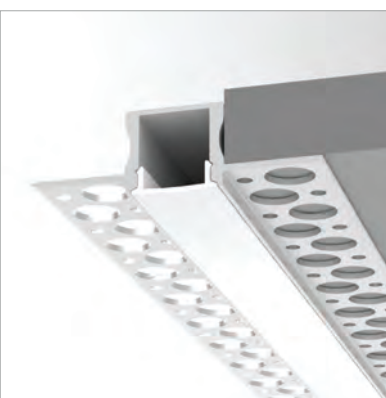

Strip led Max: L 12; H 12

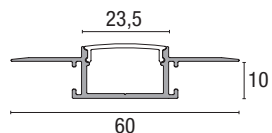
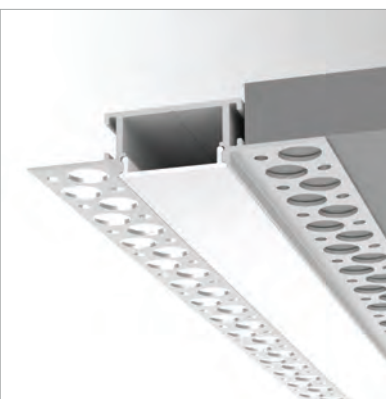

Strip led Max: L 18; H 12

Profiles

description	pieces	colour	code
profilo alluminio / preforato 200 cm drilled aluminium / profile 200 cm	1 x	●	PRO2001 opal diffuser included

Accessories

diffusore 200 cm / diffuser 200 cm	1 x	opal	PRO2005
tappi terminali / end caps	2 x	grey	PRO2008

Profiles

description	pieces	colour	code
profilo alluminio preforato 200 cm drilled aluminium profile 200 cm	1 x	●	PRO2002 opal diffuser included

Accessories

diffusore 200 cm / diffuser 200 cm	1 x	opal	PRO2003
tappi terminali / end caps	2 x	white	PRO2004

Profiles

description	pieces	colour	code
profilo alluminio preforato 200 cm drilled aluminium profile 200 cm	1 x	●	PRO2060 opal diffuser included
profilo alluminio preforato 300 cm drilled aluminium profile 300 cm	1 x	●	PRO2061 opal diffuser included



Accessories

diffusore 200 cm / diffuser 200 cm	1 x	opal	PRO2063
diffusore 300 cm / diffuser 300 cm	1 x	transparent	PRO2064
tappi terminali / end caps	2 x	grey	PRO2067

Profiles





description	pieces	colour	code
profilo alluminio preforato 200 cm drilled aluminium profile 200 cm	1 x	●	PRO2130 opal diffuser included
profilo alluminio preforato 300 cm drilled aluminium profile 300 cm	1 x	●	PRO2131 opal diffuser included

Accessories

diffusore 200 cm / diffuser 200 cm	1 x	opal	PRO2134
diffusore 300 cm / diffuser 300 cm	1 x	opal	PRO2135
tappi terminali / end caps	2 x	grey	PRO2136
connessione 90° / 90° connection	2 x		PRO2137
connessione 180° / 180° connection	2 x		PRO2138



PLASTERBOARD_RECESSED

Profiles

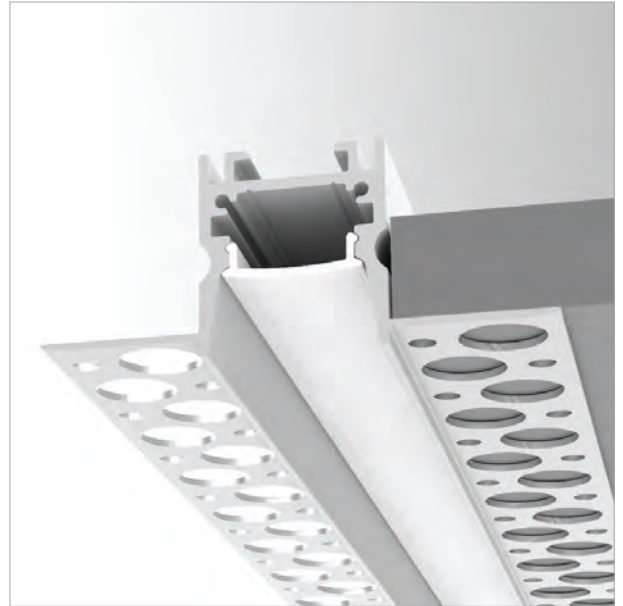
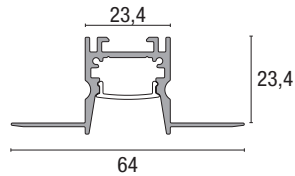
description	pieces	colour	code
profilo alluminio preforato 200 cm drilled aluminium profile 200 cm	1 x		PRO2141 opal diffuser included
	1 x		PRO2142 black diffuser included
profilo alluminio preforato 300 cm drilled aluminium profile 300 cm	1 x		PRO2143 opal diffuser included
	1 x		PRO2144 black diffuser included



Accessories

diffusore 200 cm diffuser 200 cm	1 x	opal	PRO2148
	1 x	black	PRO2149
	1 x	prismatic	PRO2159
diffusore 300 cm diffuser 300 cm	1 x	opal	PRO2151
	1 x	black	PRO2152
	1 x	prismatic	PRO2153
tappi terminali end caps	2 x	white	PRO2154
	2 x	black	PRO2154B
connessione 180° 180° connection		1 x	PRO2158
connessione 90° 90° connection		1 x	PRO2158A
connessione 90° verticale vertical 90° connection		1 x	PRO2158C

EFFICIENZA E COMFORT VISIVO.

EFFICIENCY AND VISUAL COMFORT.

La scelta di componenti qualificati migliora la qualità degli ambienti. L'impiego di un profilo con sorgente arretrata ed uno schermo luminoso microprismatico accrescono il valore dell'installazione garantendo la massima efficienza luminosa.

Qualified components improve the quality of the environments. Aluminium profiles with recessed source and microprismatic shade increase the installation value with maximum luminous efficiency.

Per la configurazione microprismatica è necessario ordinare il diffusore cod. PRO2159 o PRO2153.

Microprismatic version
order shade code
PRO2159 or PRO2153.

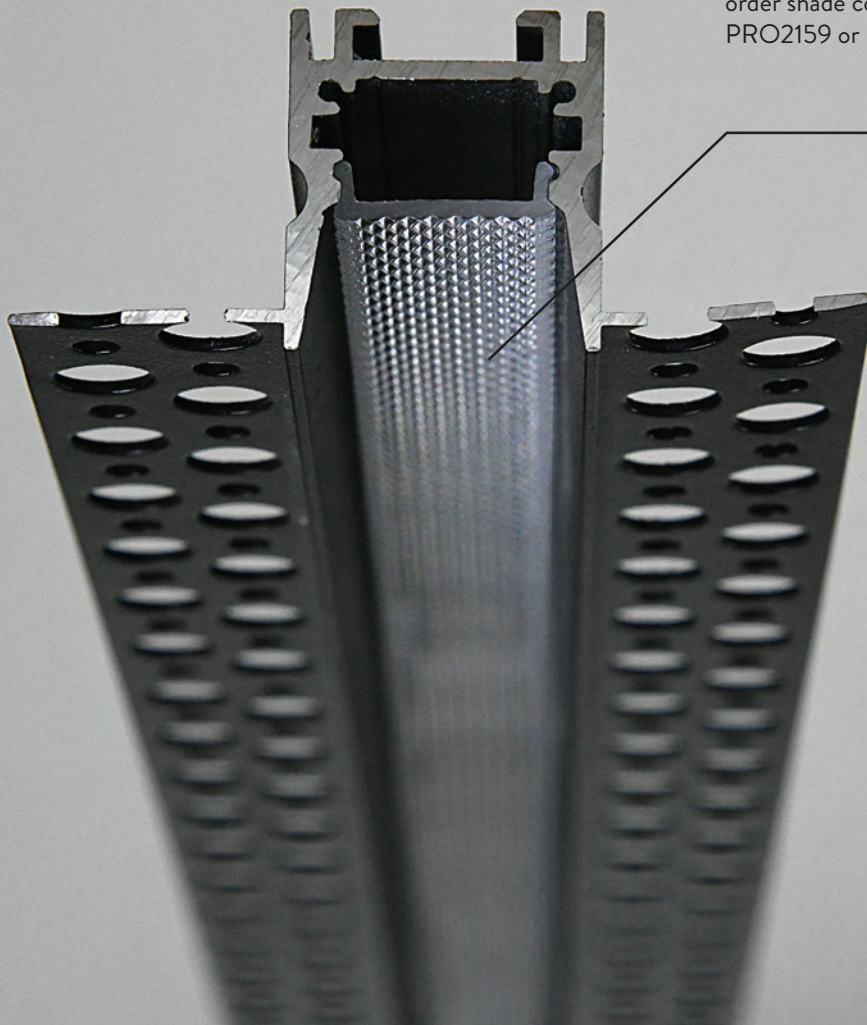





PLASTERBOARD_RECESSED

Profiles

Description	pieces	colour	code
profilo alluminio preforato 200 cm drilled aluminium profile 200 cm	1 x	●	PRO2169 opal diffuser included
profilo alluminio preforato 300 cm drilled aluminium profile 300 cm	1 x	●	PRO2170 opal diffuser included

Accessories

diffusore 200 cm diffuser 200 cm	1 x	opal	PRO2171
diffusore 300 cm / diffuser 300 cm	1 x	opal	PRO2172
tappi terminali / end caps	2 x	white	PRO2173
connessione 180° 180° connection	 1 x		PRO2174
connessione 90° 90° connection	 1 x		PRO2175
connessione 120° 120° connection	 1 x		PRO2176
connessione 90° verticale vertical 90° connection	 1 x		PRO2177

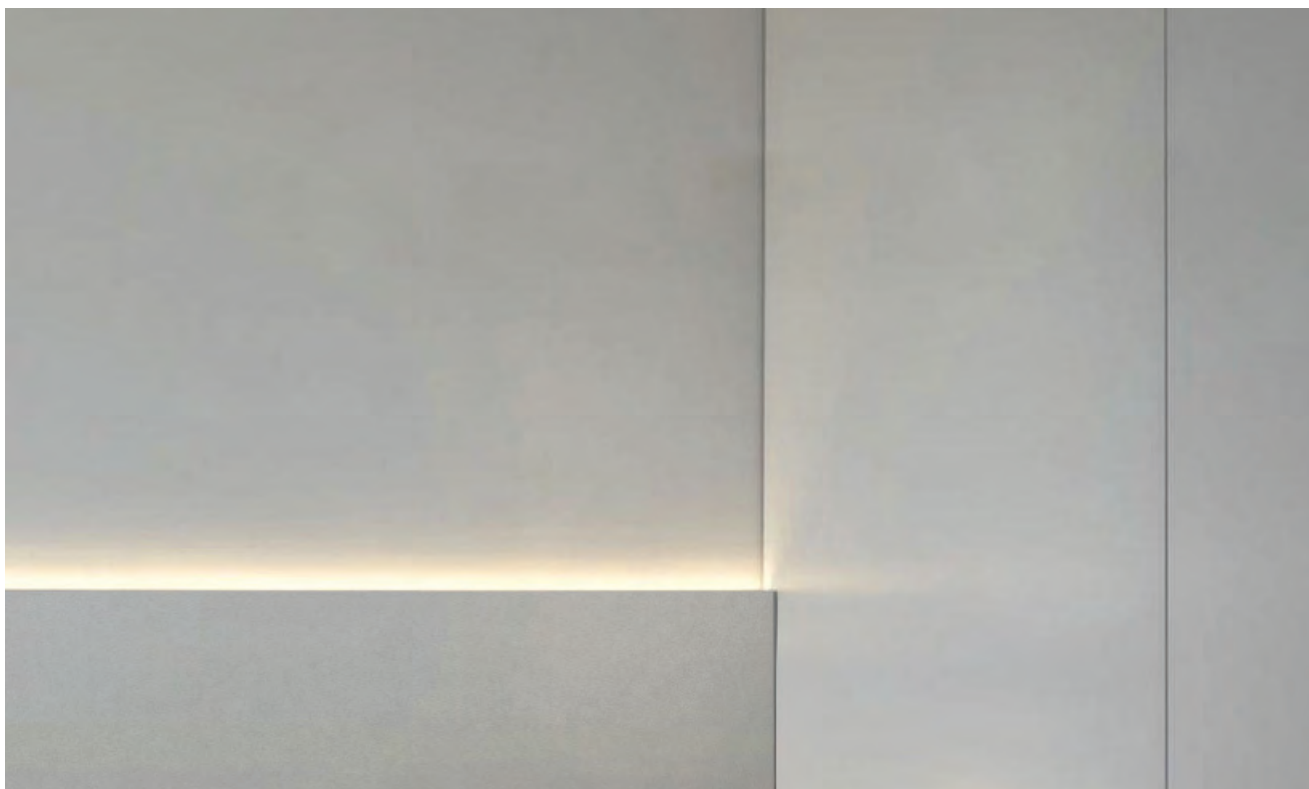
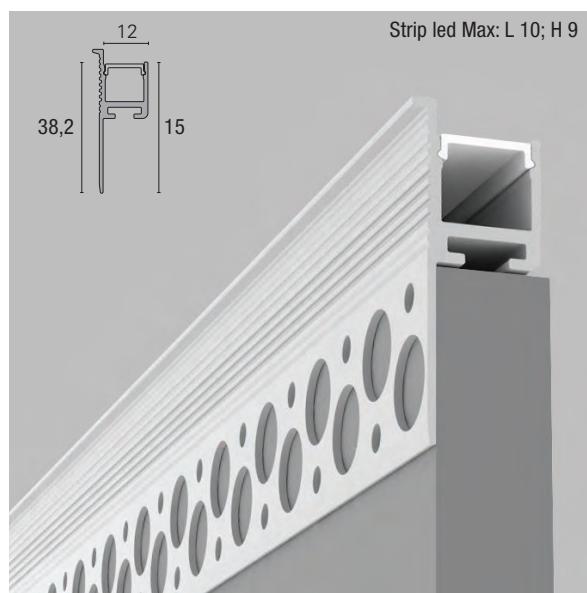

VERSATILITÀ NELLE
SCELTE PROGETTUALI.

VERSATILITY

IN DESIGN CHOICE.

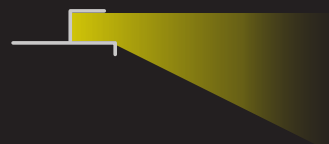
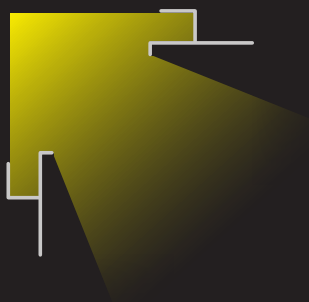
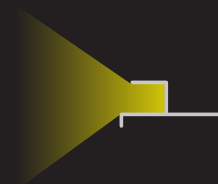



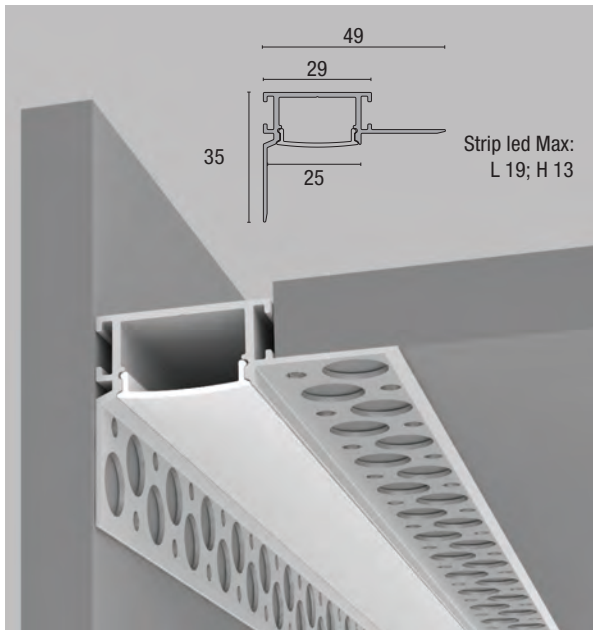

PLASTERBOARD_RECESSED



Profiles

Description	pieces	colour	code
profilo alluminio preforato 200 cm drilled aluminium profile 200 cm	1 x	●	PRO2160 opal diffuser included
profilo alluminio preforato 300 cm drilled aluminium profile 300 cm	1 x	●	PRO2161 opal diffuser included

Accessories

diffusore 200 cm diffuser 200 cm	1 x	opal	PRO2162
diffusore 300 cm / diffuser 300 cm	1 x	opal	PRO2163
tappi terminali / end caps	2 x	white	PRO2164
connessione 180° 180° connection	 1 x		PRO2165
connessione 90° 90° connection	 1 x		PRO2166
connessione 120° 120° connection	 1 x		PRO2167
connessione 90° verticale vertical 90° connection	 1 x		PRO2168

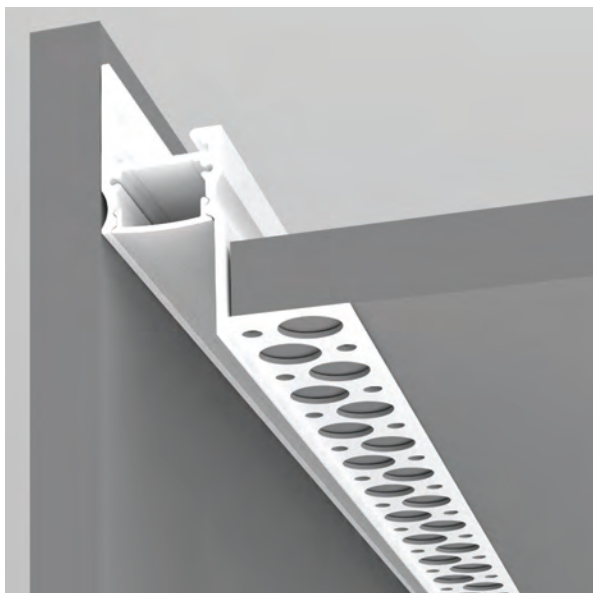

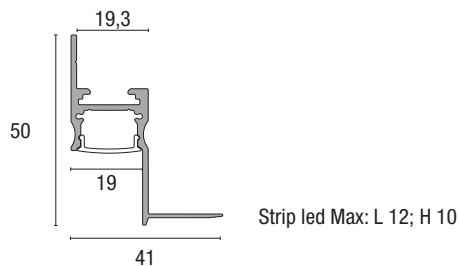

Profiles

Description	pieces	colour	code
profilo alluminio preforato 200 cm drilled aluminium profile 200 cm	1 x	○	PRO2178 opal diffuser included
profilo alluminio preforato 300 cm drilled aluminium profile 300 cm	1 x	○	PRO2179 opal diffuser included



Accessories

diffusore 200 cm diffuser 200 cm	1 x	opal	PRO2148
diffusore 300 cm / diffuser 300 cm	1 x	opal	PRO2151
tappi terminali / end caps	2 x	white	PRO2180
connessione 180° 180° connection	 1 x		PRO2158
connessione 90° 90° connection	 1 x		PRO2158A

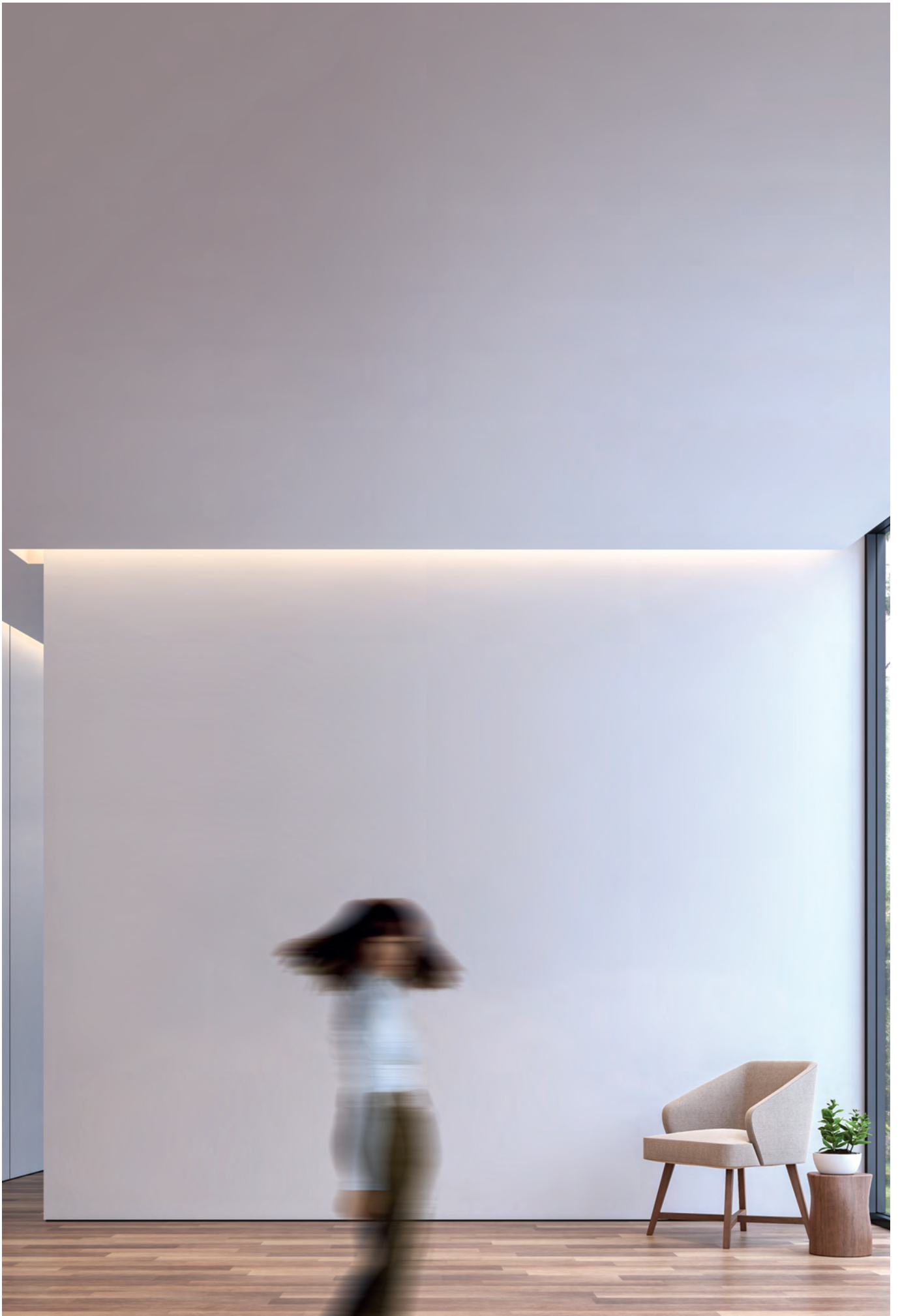





PLASTERBOARD_RECESSED

Profiles

Description	pieces	colour	code
profilo alluminio preforato 200 cm drilled aluminium profile 200 cm	1 x		PR02183 opal diffuser included
profilo alluminio preforato 300 cm drilled aluminium profile 300 cm	1 x		PR02184 opal diffuser included

Accessories

diffusore 200 cm diffuser 200 cm	1 x	opal	PR02185
diffusore 300 cm / diffuser 300 cm	1 x	opal	PR02186
tappi terminali / end caps	2 x	white	PR02187
connessione 180° 180° connection	 1 x		PR02195
connessione 90° 90° connection	 1 x		PR02196
connessione 120° 120° connection	 1 x		PR02198
connessione 90° verticale vertical 90° connection	 1 x		PR02197

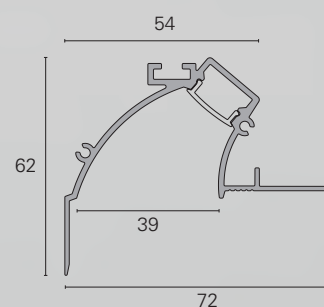

Strip led Max: L 12; H 8

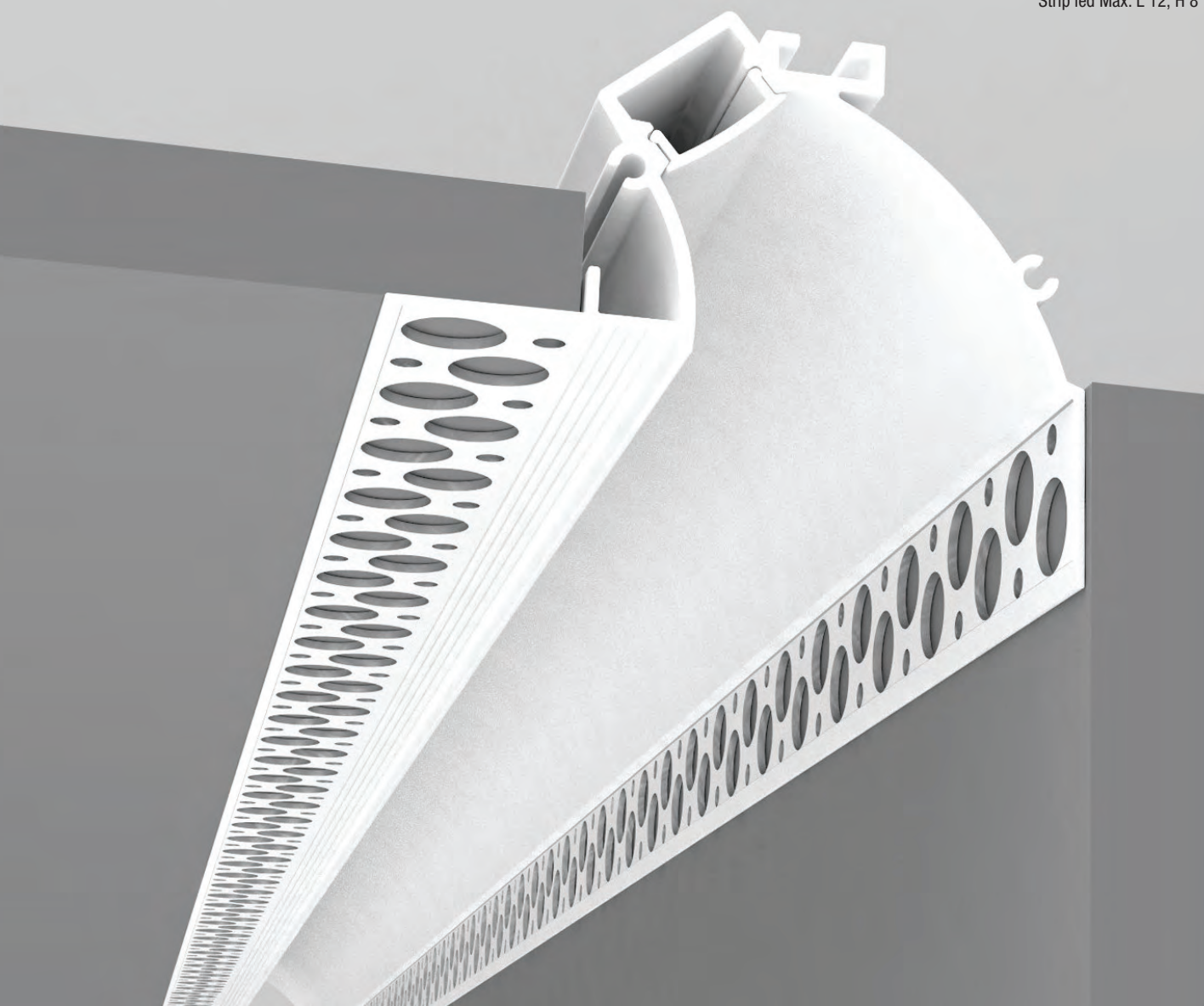



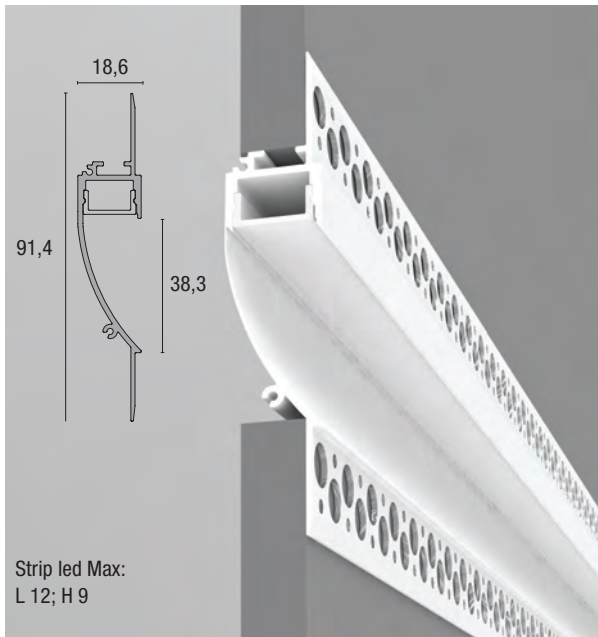

PLASTERBOARD_RECESSED



Profiles

Description	pieces	colour	code
profilo alluminio preforato 200 cm drilled aluminium profile 200 cm	1 x	○ opal diffuser included	PRO2101
profilo alluminio preforato 300 cm drilled aluminium profile 300 cm	1 x	○ opal diffuser included	PRO2102

Accessories

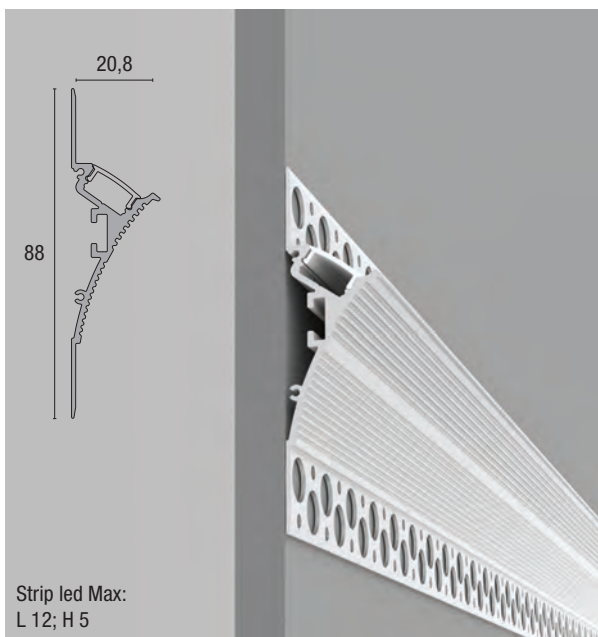

diffusore 200 cm diffuser 200 cm	1 x	opal	PRO2106
diffusore 300 cm / diffuser 300 cm	1 x	opal	PRO2107
tappi terminali / end caps	2 x	white	PRO2108
connessione 180° 180° connection	 1 x		PRO2195
connessione 90° 90° connection	 1 x		PRO2196
connessione 90° verticale vertical 90° connection	 1 x		PRO2197



Profiles

Description	pieces	colour	code
profilo alluminio preforato 200 cm drilled aluminium profile 200 cm	1 x	○ opal diffuser included	PRO2192

Accessories

diffusore 200 cm diffuser 200 cm	1 x	opal	PRO2193
tappi terminali / end caps	2 x	white	PRO2194
connessione 180° 180° connection	 1 x		PRO2195
connessione 90° 90° connection	 1 x		PRO2196
connessione 90° verticale vertical 90° connection	 1 x		PRO2197



UN TAGLIO
DI LUCE
ACCRESCE
IL VALORE
DELL'INSTALLAZIONE.

A "CUT OF LIGHT"
INCREASE THE VALUE
OF THE INSTALLATION.

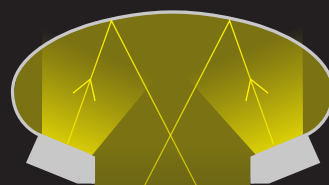

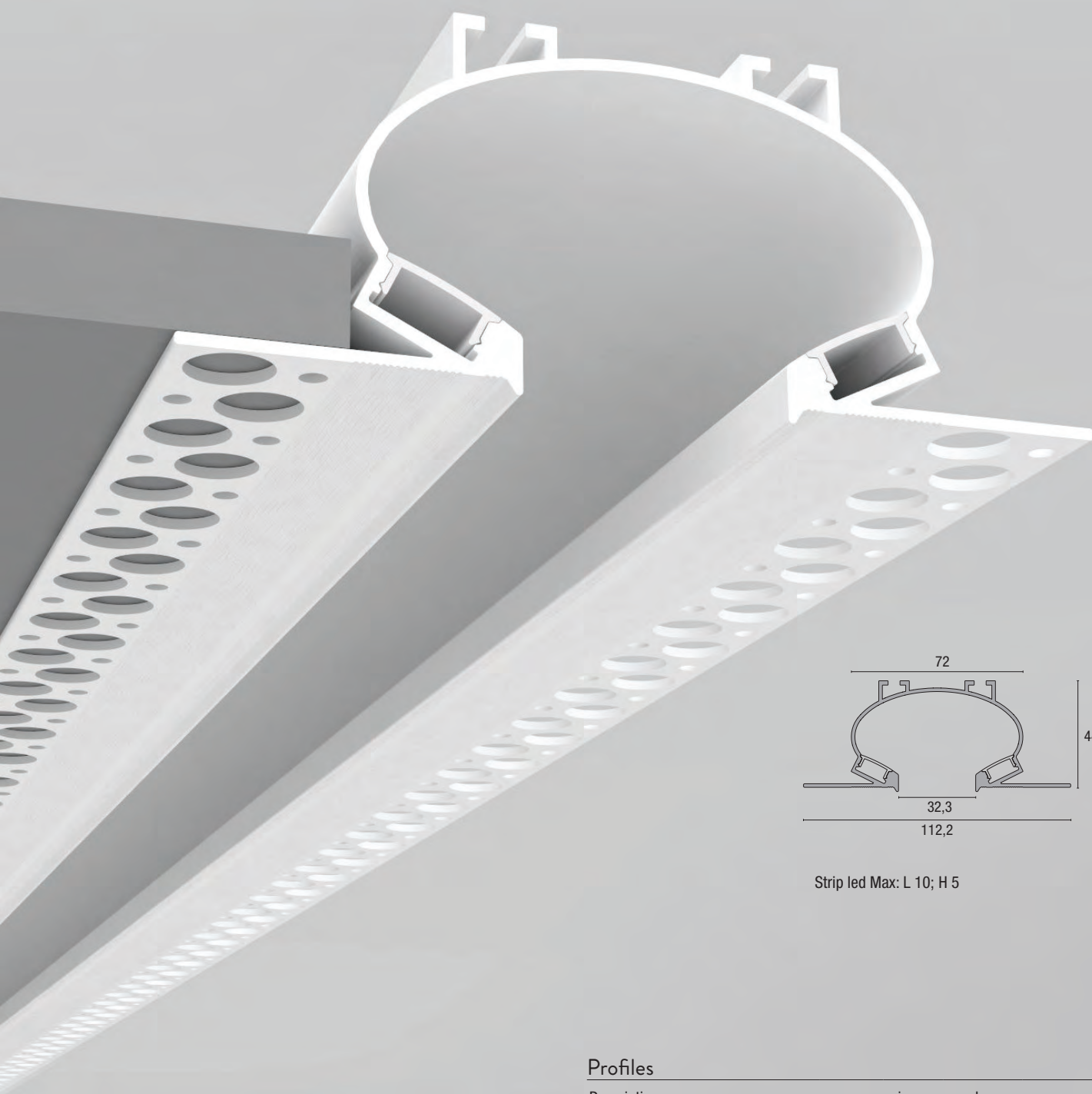



Strip led Max: L 10; H 5

Profiles

Description	pieces	colour	code
profilo alluminio preforato 200 cm drilled aluminium profile 200 cm	1 x	 opal diffuser included	PRO2210
profilo alluminio preforato 300 cm drilled aluminium profile 300 cm	1 x	 opal diffuser included	PRO2211

Accessories

tappi terminali / end caps	2 x	white	PRO2212
connessione 180° 180° connection	 2 x		PRO2213
connessione 90° verticale vertical 90° connection	 2x		PRO2214

PLASTERBOARD_RECESSED

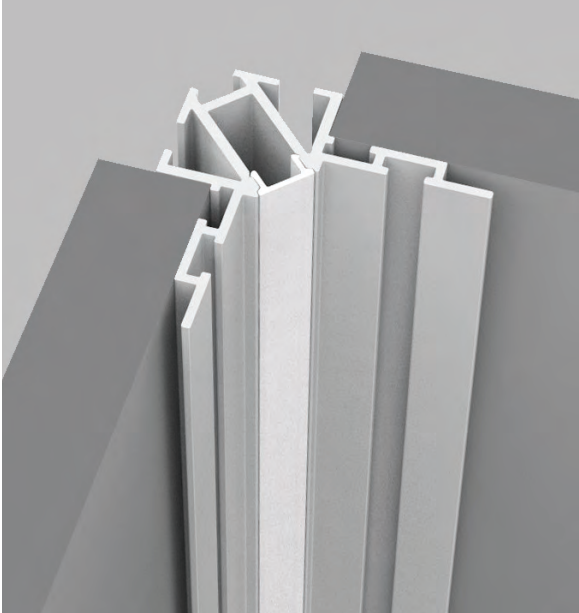

Profiles

Description	pieces	colour	code
profilo alluminio preforato 200 cm drilled aluminium profile 200 cm	1 x	● opal	PRO2040 opal diffuser included

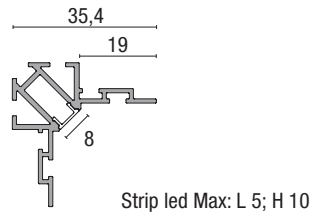

Accessories

diffusore 200 cm diffuser 200 cm	1 x	opal	PRO2043
tappi terminali / end caps	2 x	grey	PRO2046
connessione 180° 180° connection	2 x		PRO2048

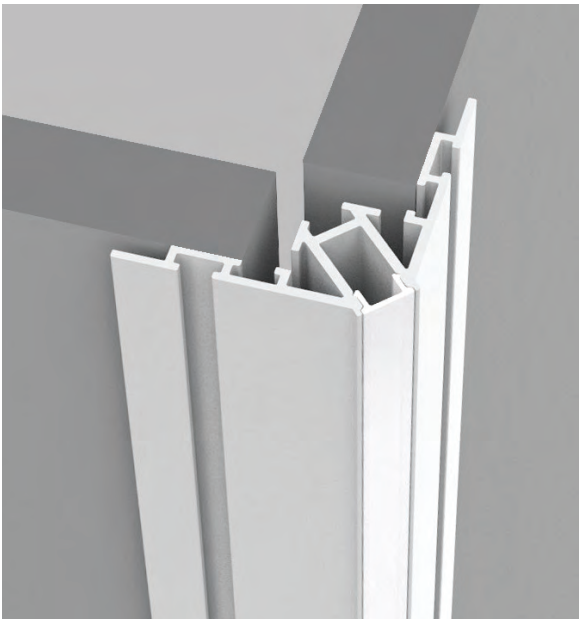

Profiles

Description	pieces	colour	code
profilo alluminio preforato 200 cm drilled aluminium profile 200 cm	1 x	● opal	PRO2050 opal diffuser included

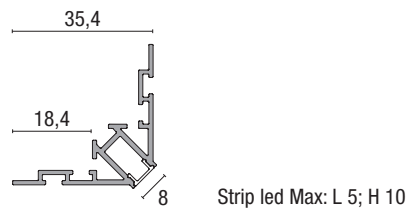

Accessories

diffusore 200 cm diffuser 200 cm	1 x	opal	PRO2053
tappi terminali / end caps	2 x	grey	PRO2046
connessione 180° 180° connection	2 x		PRO2048



RECESSED PROFILES



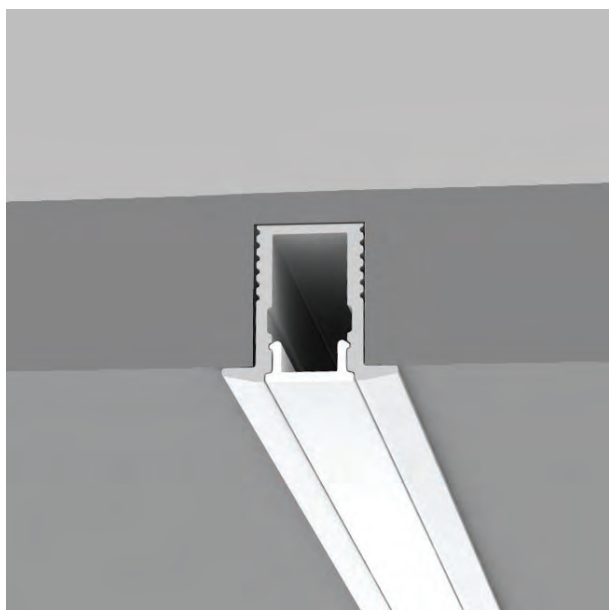

Profiles

description	pieces	colour	code
profilo alluminio 200 cm aluminium profile 200 cm	1 x	●	PRO2020 opal diffuser included
	1 x	○	PRO2021 opal diffuser included
	1 x	●	PRO2022 opal diffuser included

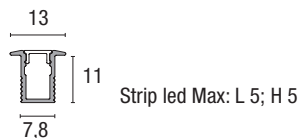

Accessories

diffusore 200 cm diffuser 200 cm	1 x	opal	PRO2005
	1 x	black	PRO2006
	2 x	grey	PRO2026
tappi terminali end caps	2 x	white	PRO2027
	2 x	black	PRO2028
clips di fissaggio fixing clips	 2 x		PRO2029

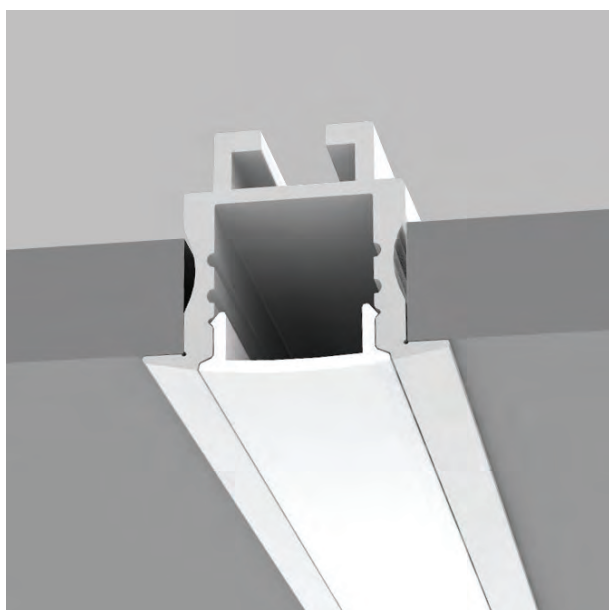

Profiles

description	pieces	colour	code
profilo alluminio 200 cm aluminium profile 200 cm	1 x	●	PRO2090 opal diffuser included
	1 x	○	PRO2091 opal diffuser included

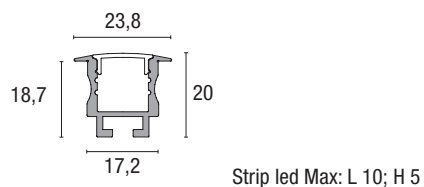

Accessories

diffusore 200 cm diffuser 200 cm	1 x	opal	PRO2084
	1 x	transparent	PRO2085
tappi terminali end caps	2 x	grey	PRO2097
	2 x	white	PRO2098
clips di fissaggio fixing clips	 2 x		PRO2099

RECESSED PROFILES

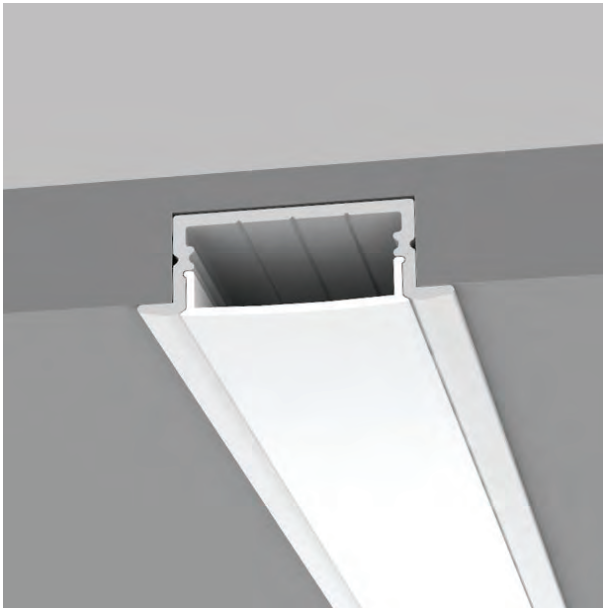

Profiles

description	pieces	colour	code
profilo alluminio 200 cm aluminium profile 200 cm	1 x	●	PRO1021 opal diffuser included
	1 x	○	PRO1022 opal diffuser included

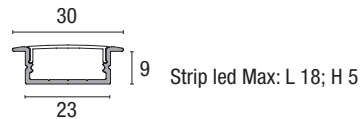

Accessories

diffusore 200 cm diffuser 200 cm	1 x	opal	PRO1021B
	1 x	transparent	PRO1021C
tappi terminali end caps	2 x	grey	PRO1037
	2 x	white	PRO1037B
clips di fissaggio fixing clips	2 x		PRO1030

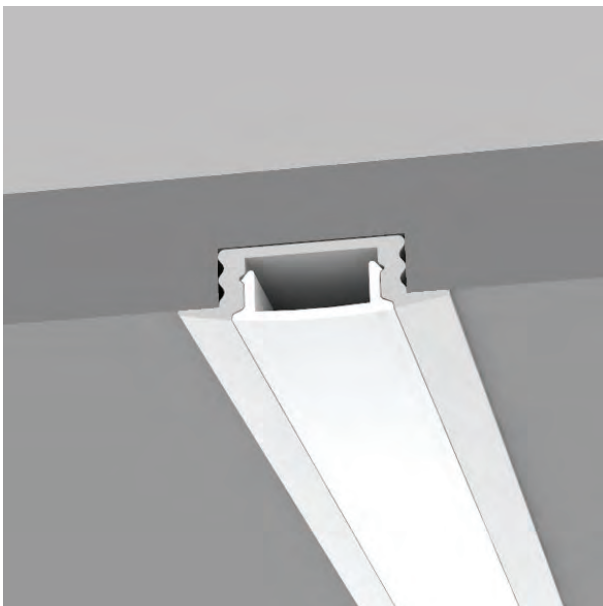

Profiles

description	pieces	colour	code
profilo alluminio 200 cm aluminium profile 200 cm	1 x	●	PRO2080 opal diffuser included
	1 x	○	PRO2081 opal diffuser included
	1 x	●	PRO2082 opal diffuser included

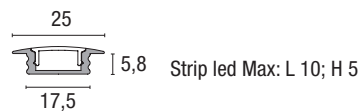

Accessories

diffusore 200 cm diffuser 200 cm	1 x	opal	PRO2084
	1 x	transparent	PRO2085
	1 x	black	PRO2086
tappi terminali end caps	2 x	grey	PRO2087
	2 x	white	PRO2088
	2 x	black	PRO2092
clips di fissaggio fixing clips	2 x		PRO2089



RECESSED PROFILES

Profiles

description	pieces	colour	code
profilo alluminio 200 cm aluminium profile 200 cm	1 x	●	PR01015

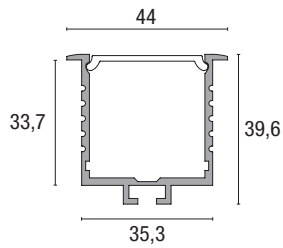

Strip led Max: L 30; H 30

Accessories

diffusore 200 cm / diffuser 200 cm	1 x	opal	PR01016
tappi terminali / end caps	2 x	grey	PR01035
clips di fissaggio fixing clips	2 x		PR01039

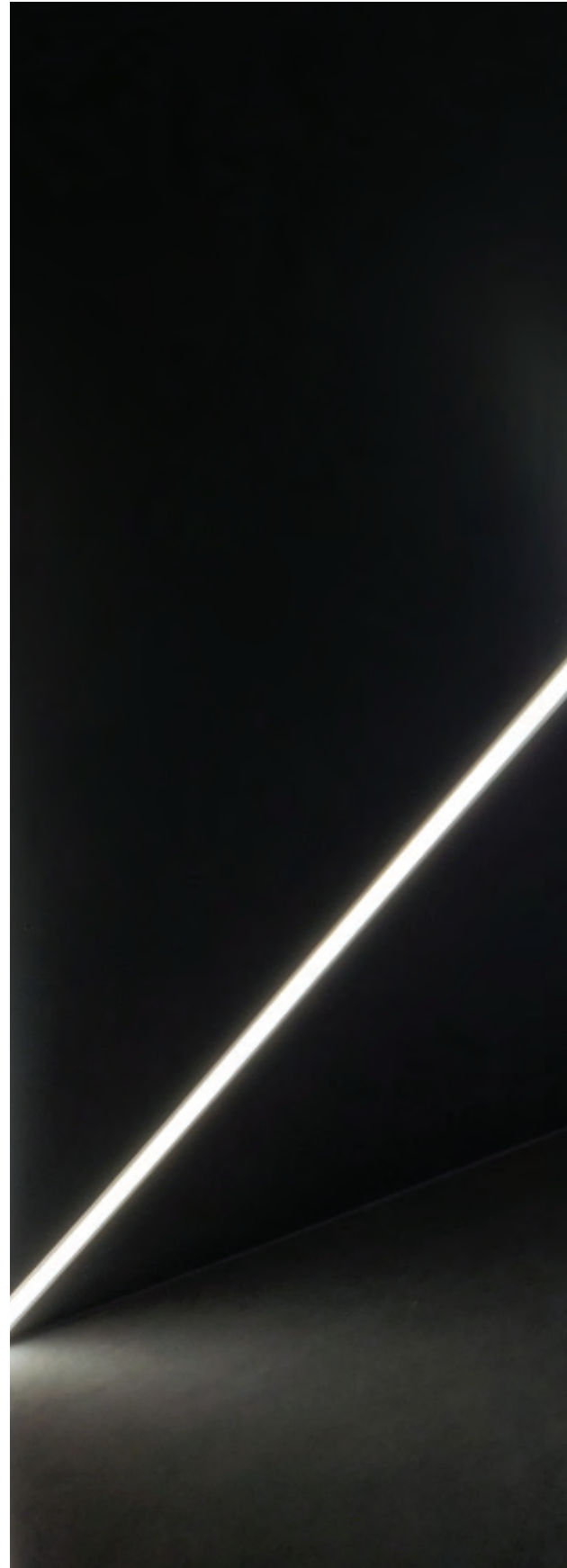
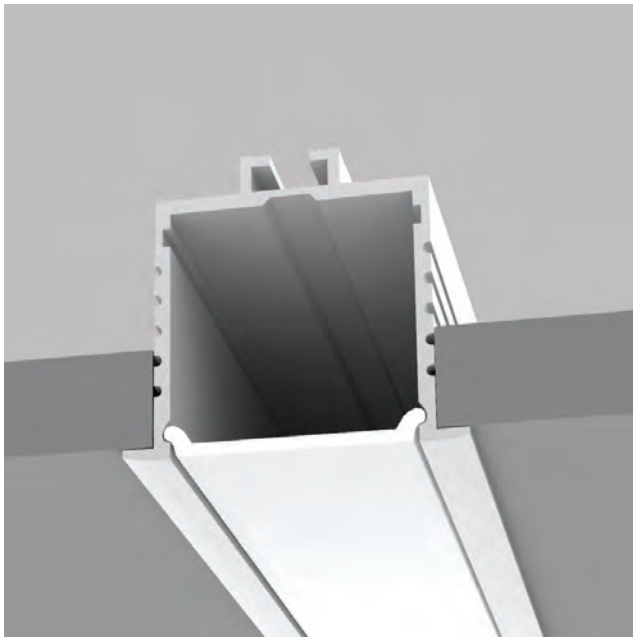



SURFACE MOUNTED PROFILES

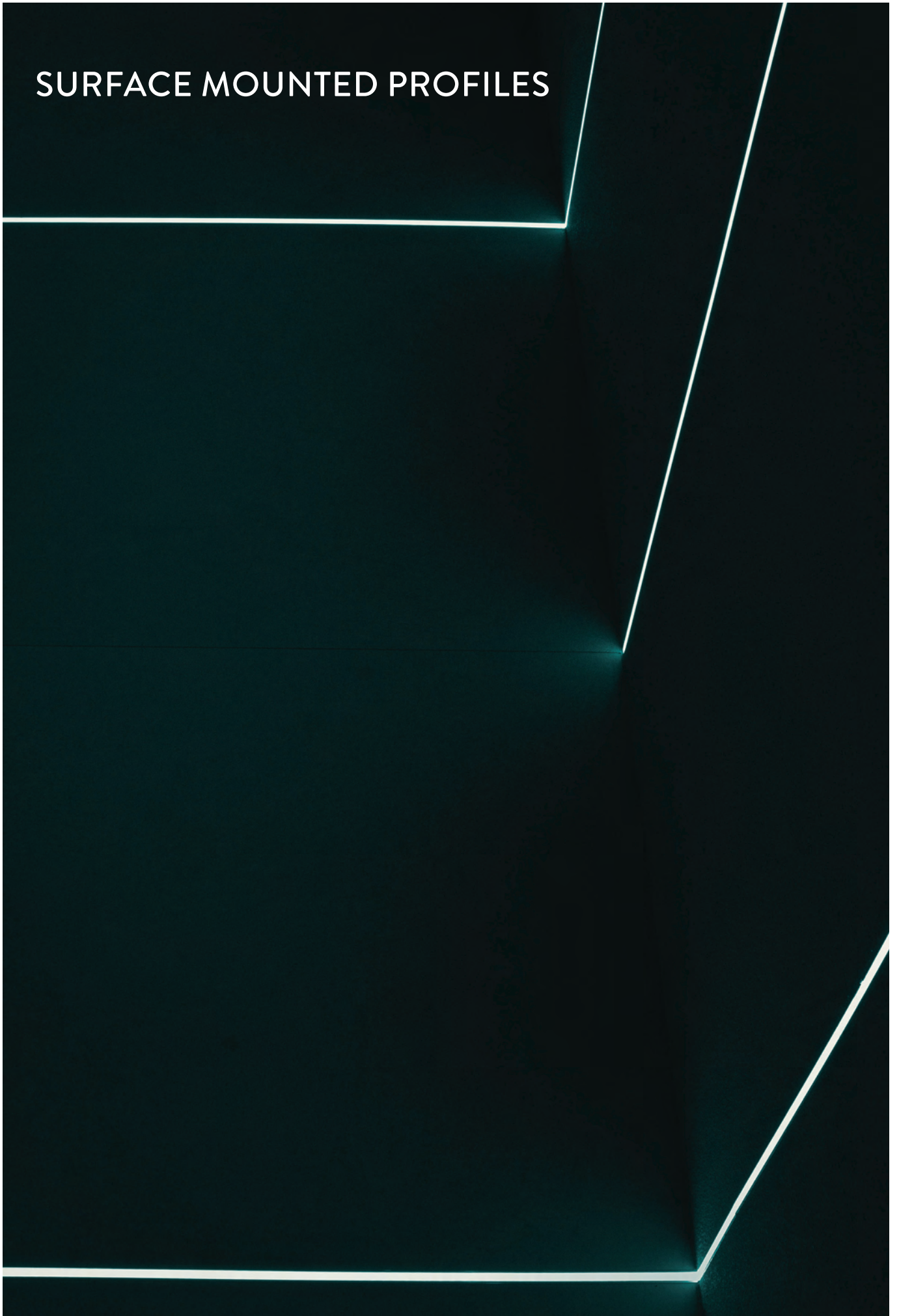

Profiles

description	pieces	colour	code
profilo alluminio 200 cm aluminium profile 200 cm	1 x	●	PRO2010 opal diffuser included
	1 x	○	PRO2011 opal diffuser included
	1 x	●	PRO2012 opal diffuser included
profilo alluminio 300 cm aluminium profile 300 cm	1 x	●	PRO2013 opal diffuser included
	1 x	○	PRO2014 opal diffuser included
	1 x	●	PRO2015 opal diffuser included

Accessories

diffusore 200 cm diffuser 200 cm	1 x	opal	PRO2005
	1 x	black	PRO2006
tappi terminali end caps	2 x	grey	PRO2017
	2 x	white	PRO2018
	2 x	black	PRO2019
clips di fissaggio fixing clips	2 x		PRO2016

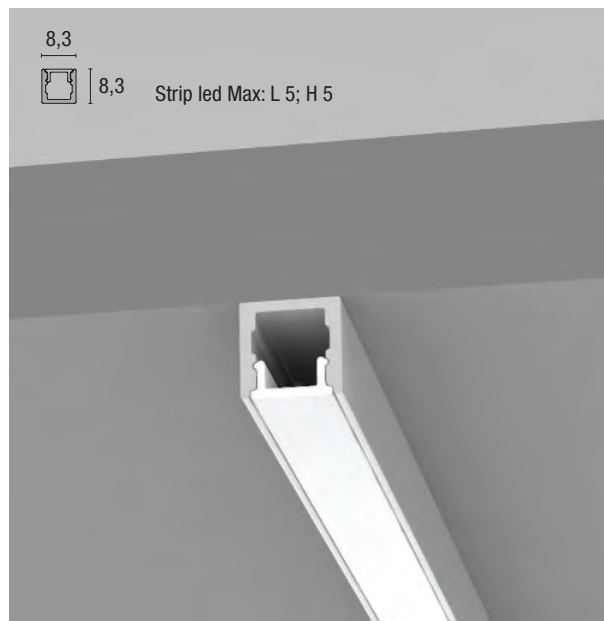

Profiles

description	pieces	colour	code
profilo alluminio 200 cm aluminium profile 200 cm	1 x	●	PRO1025 opal diffuser included
	1 x	○	PRO1026 opal diffuser included
	1 x	●	PRO1027 opal diffuser included

Accessories

diffusore 200 cm diffuser 200 cm	1 x	opal	PRO1025B
	1 x	transparent	PRO1025C
	1 x	black	PRO1027A
tappi terminali end caps	2 x	grey	PRO1025D
	2 x	white	PRO1026D
	2 x	black	PRO1027D
clips di fissaggio fixing clips	2 x		PRO1028
clips orientabili adjustable clips	2 x		PRO1029

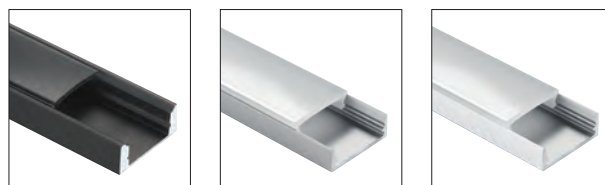
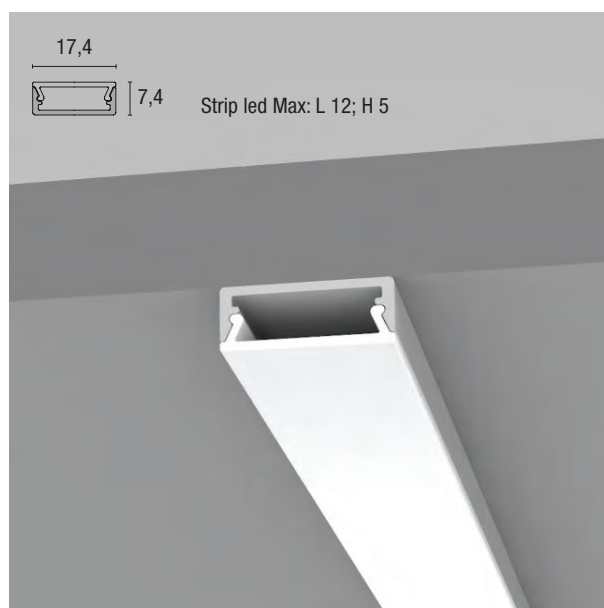

SURFACE MOUNTED PROFILES

Profiles

description	pieces	colour	code
profilo alluminio 200 cm aluminium profile 200 cm	1 x	●	PRO2070 opal diffuser included
	1 x	○	PRO2071 opal diffuser included

Accessories

diffusore 200 cm diffuser 200 cm	1 x	opal	PRO1025B
	1 x	trasparent	PRO1025C
tappi terminali end caps	2 x	grey	PRO2077
	2 x	white	PRO2078
clips di fissaggio fixing clips	2 x		PRO2079

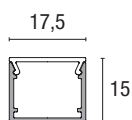
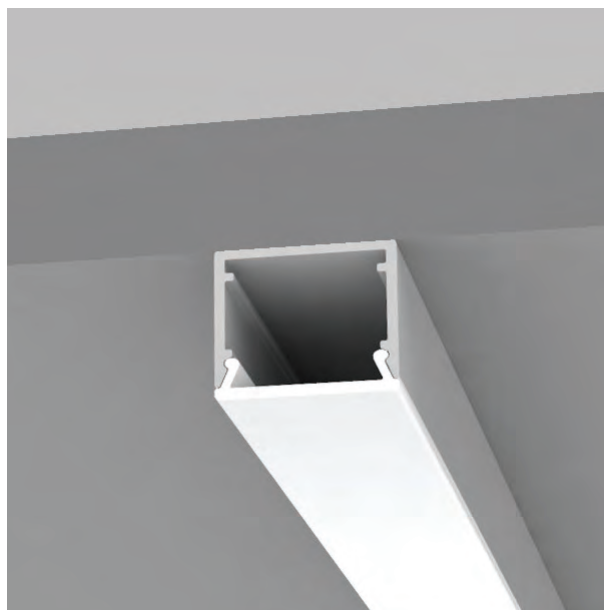

Strip led Max: L 12; H 12

Profiles

description	pieces	colour	code
profilo alluminio 200 cm aluminium profile 200 cm	1 x	●	PRO1020 opal diffuser included
	1 x	○	PRO1020B opal diffuser included
	1 x	●	PRO1023 opal diffuser included
profilo alluminio 300 cm aluminium profile 300 cm	1 x	●	PRO1020S opal diffuser included
	1 x	○	PRO1020W opal diffuser included
	1 x	●	PRO1024 opal diffuser included

Accessories

diffusore 200 cm diffuser 200 cm	1 x	opal	PRO1020D
	1 x	transparent	PRO1020E
	1 x	black	PRO1024B
tappi terminali end caps	2 x	grey	PRO1036
	2 x	white	PRO1036B
	2 x	black	PRO1035B
clips di fissaggio fixing clips	2 x		PRO1033

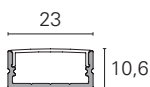

Strip led Max: L 18; H 8

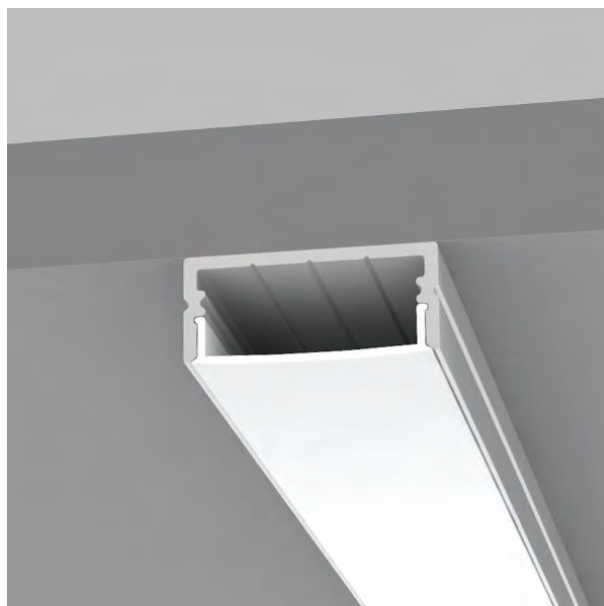



UN BUON COMFORT VISIVO. GOOD VISUAL COMFORT.

la ricerca e l'attenzione verso il dettaglio aiutano nella crescita qualitativa del prodotto. Piccoli accorgimenti marcano la differenza e qualificano il progetto. Questi profili, disponibili in tre misure garantiscono il comfort visivo ottimale mantenendo inalterata la semplicità d'installazione e l'alto livello estetico.

Research and details attention are extremely important to grant the product qualitative growth. Small tricks mark the difference and qualify the projects. These profiles, available in three sizes, ensure optimal visual comfort keeping an easy installation and high aesthetic level.

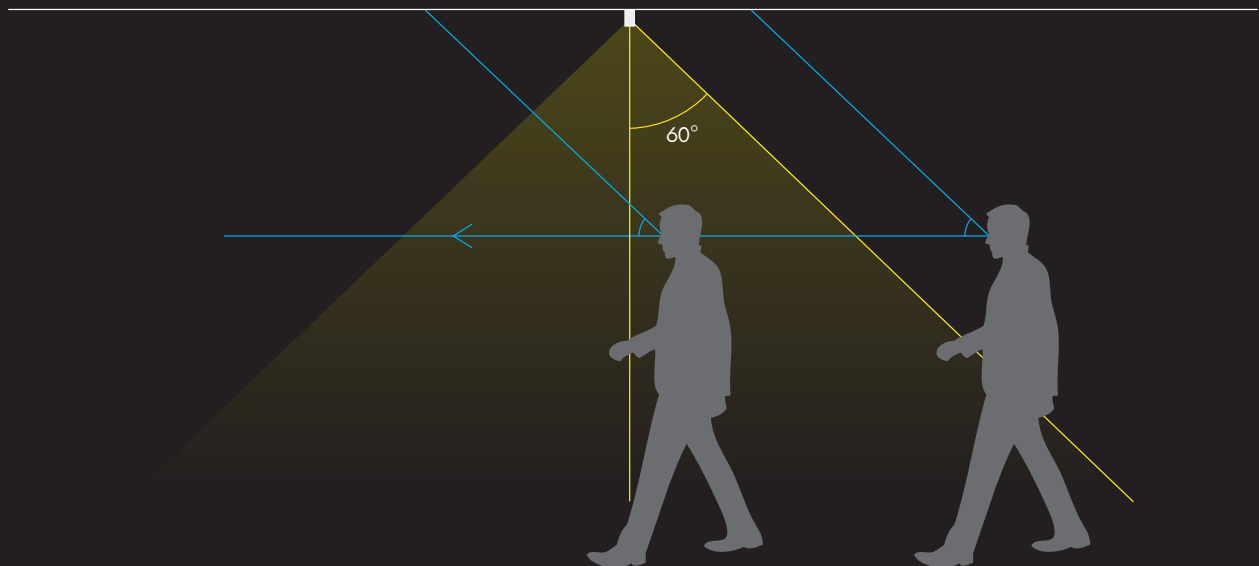

Profiles

description	pieces	colour	code
profilo alluminio 200 cm aluminium profile 200 cm	1 x	○	PRO2215 opal diffuser included
	1 x	●	PRO2216 opal diffuser included

Accessories

diffusore 200 cm diffuser 200 cm	1 x	trasparent	PRO2217
	1 x	opal	PRO2218
	1 x	black	PRO2219
tappi terminali end caps	2 x	white	PRO2220
	2 x	black	PRO2221

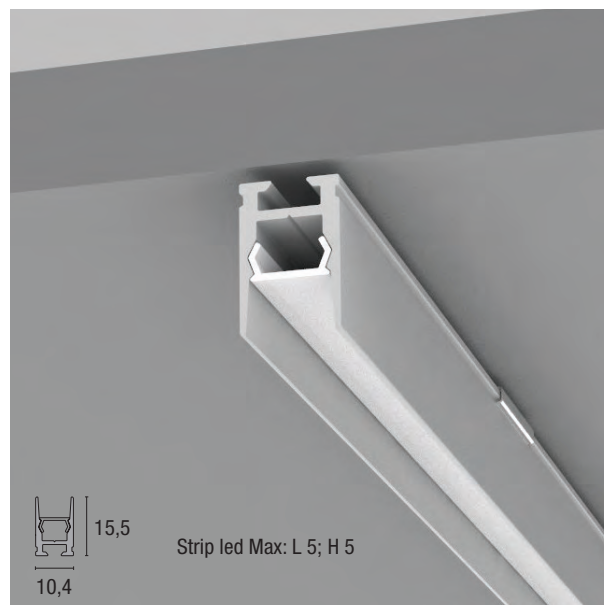

Profiles

description	pieces	colour	code
profilo alluminio 200 cm aluminium profile 200 cm	1 x	○	PRO2222 opal diffuser included
	1 x	●	PRO2223 opal diffuser included

Accessories

diffusore 200 cm diffuser 200 cm	1 x	trasparent	PRO2224
	1 x	opal	PRO2225
	1 x	black	PRO2226
tappi terminali end caps	2 x	white	PRO2227
	2 x	black	PRO2228

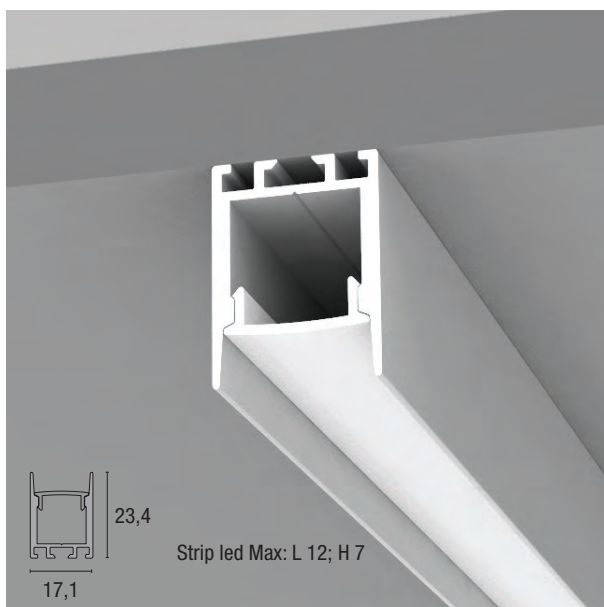

Profiles

description	pieces	colour	code
profilo alluminio 200 cm aluminium profile 200 cm	1 x	○	PRO2229 opal diffuser included
	1 x	●	PRO2230 opal diffuser included

Accessori / Accessories

diffusore 200 cm diffuser 200 cm	1 x	trasparent	PRO2231
	1 x	opal	PRO2232
	1 x	black	PRO2233
	2 x	white	PRO2234
	2 x	black	PRO2235
clips di fissaggio fixing clips	2 x		PRO2236

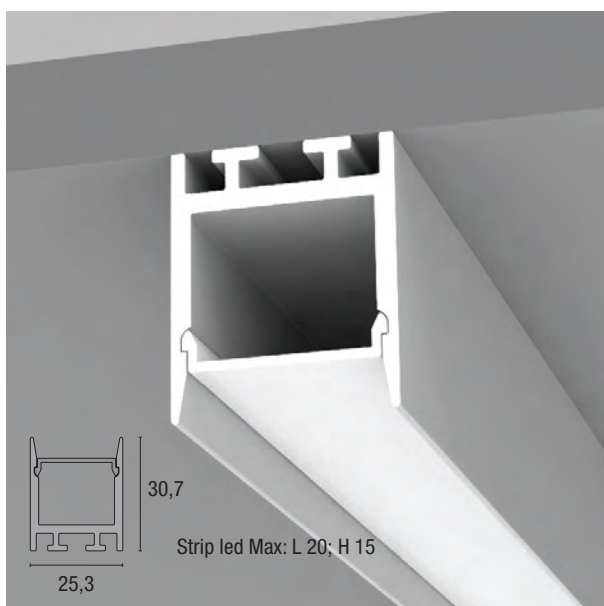

SURFACE MOUNTED PROFILES



Profiles

description	pieces	colour	code
profilo alluminio 200 cm aluminium profile 200 cm	1 x		PRO2140 opal diffuser included

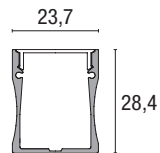



Strip led Max: L 18; H 25

Accessories

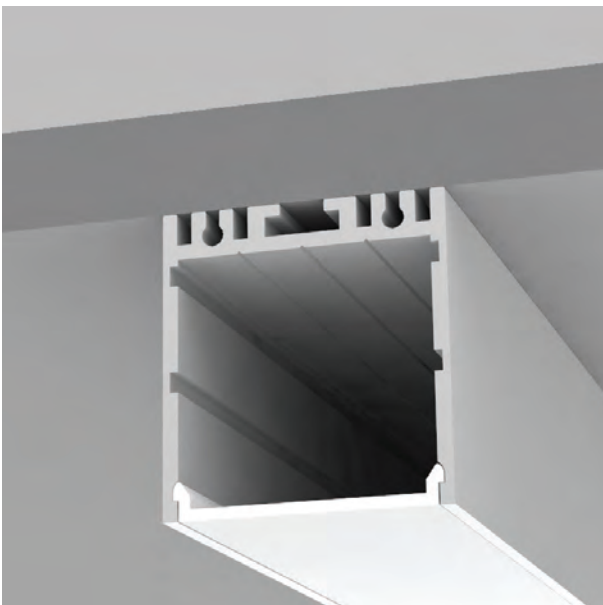
diffusore 200 cm diffuser 200 cm	1 x	opal	PRO2145
	1 x	trasparent	PRO2146
tappi terminali / end caps	2 x	white	PRO2147



Profiles

description	pieces	colour	code
profilo alluminio 200 cm aluminium profile 200 cm	1 x		PRO1013 opal diffuser included
	1 x		PRO1013A opal diffuser included

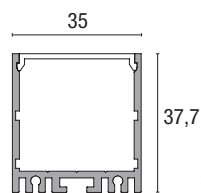

Strip led Max: L 30; H 30

Accessories

diffusore 200 cm diffuser 200 cm	1 x	opal	PRO1013B
	1 x	transparent	PRO1013C
tappi terminali end caps	2 x	grey	PRO1034
	2 x	white	PRO1034B



Profiles

description	pieces	colour	code
profilo alluminio 200 cm aluminium profile 200 cm	1 x	●	PR02030 opal diffuser included
	1 x	○	PR02031 opal diffuser included

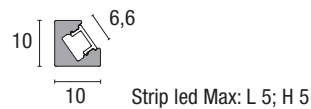

Accessories

diffusore 200 cm / diffuser 200 cm	1 x	opal	PR02005
tappi terminali end caps	2 x	grey	PR02036
	2 x	white	PR02037
clips di fissaggio fixing clips	2 x		PR02039

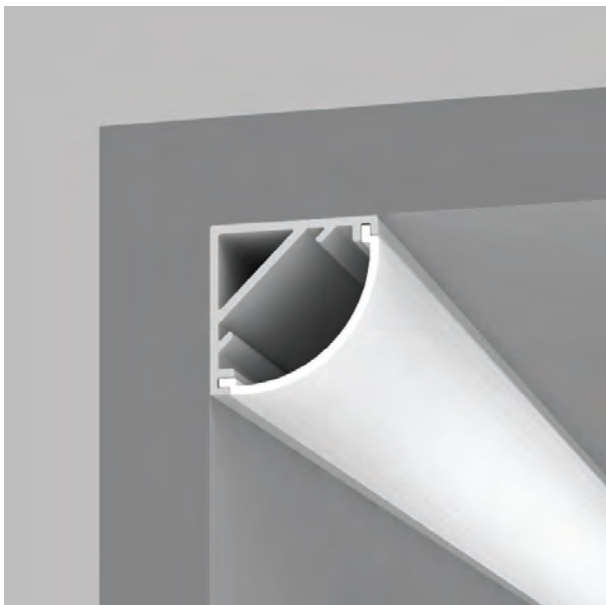

Profiles

description	pieces	colour	code
profilo alluminio 200 cm aluminium profile 200 cm	1 x	●	PR01040 opal diffuser included
	1 x	○	PR01043 opal diffuser included
	1 x	●	PR01044 opal diffuser included

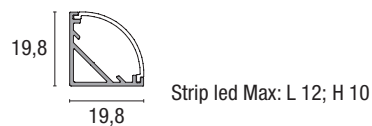

Accessories

diffusore 200 cm diffuser 200 cm	1 x	opal	PR01045
	1 x	transparent	PR01046
	1 x	black	PR01047
tappi terminali end caps	2 x	grey	PR01041
	2 x	white	PR01048
	2 x	black	PR01049
clips di fissaggio fixing clips	2 x		PR01042

SURFACE MOUNTED PROFILES

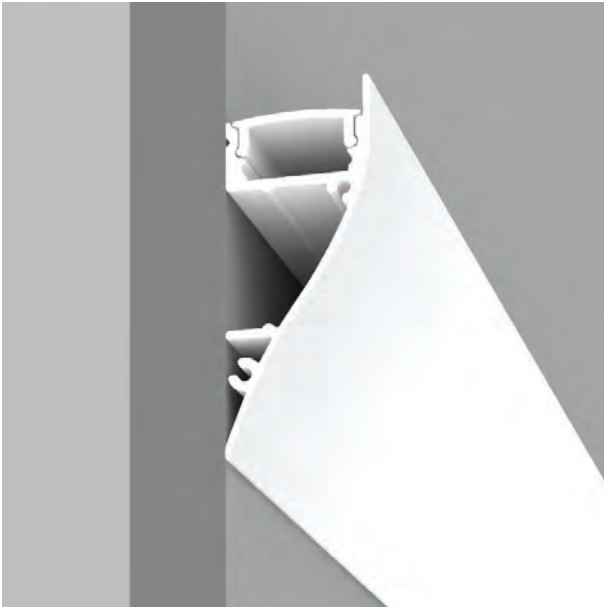

Profiles

description	pieces	colour	code
profilo alluminio 200 cm aluminium profile 200 cm	1 x	 opal diffuser included	PRO2120

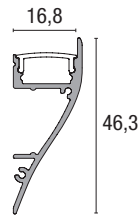

Strip led Max: L 10; H 5

Accessori / Accessories

diffusore 200 cm / diffuser 200 cm	1 x	opal	PRO2125
	1 x	transparent	PRO2126
tappi terminali / end caps	2 x	white	PRO2127
clips di fissaggio fixing clips	 2 x		PRO2128

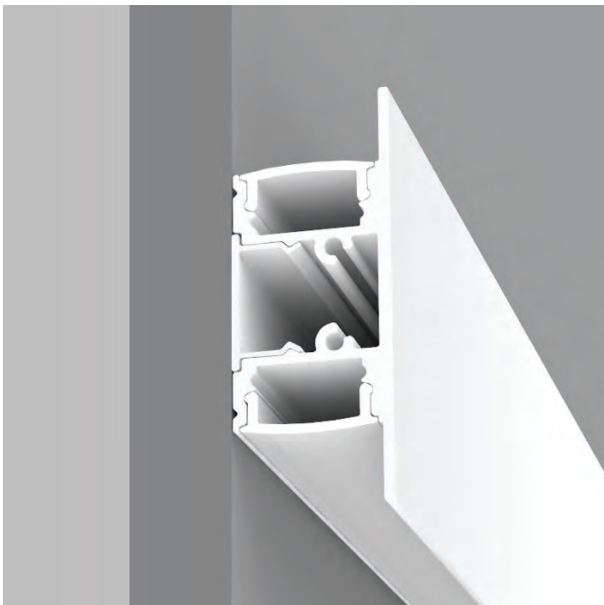

Profiles

description	pieces	colour	code
profilo alluminio 200 cm aluminium profile 200 cm	1 x	 opal diffuser included	PRO2110

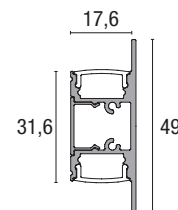

Strip led Max: L 10; H 5

Accessori / Accessories

diffusore 200 cm diffuser 200 cm	1 x	opal	PRO2115
	1 x	transparent	PRO2116
tappi terminali / end caps	2 x	white	PRO2117

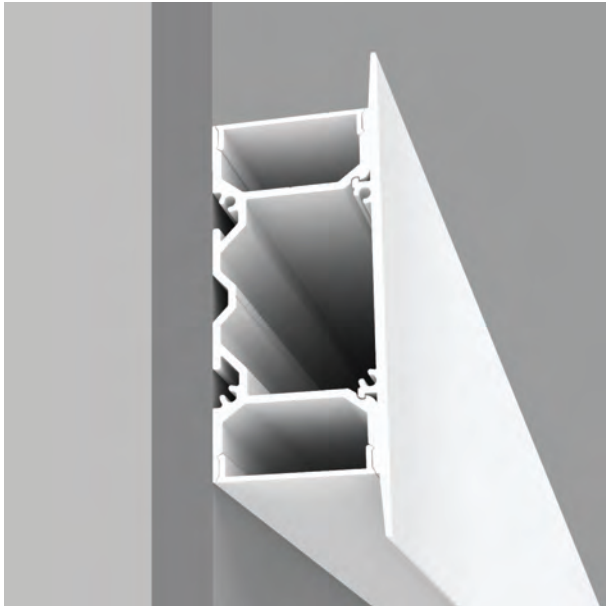

Strip led Max: L 16; H 10

Profiles

description	pieces	colour	code
profilo alluminio 200 cm aluminium profile 200 cm	1 x		PR02150 opal diffuser included

Accessori / Accessories

diffusore 200 cm diffuser 200 cm	1 x	opal	PR02155
	1 x	transparent	PR02156
tappi terminali / end caps	2 x	white	PR02157

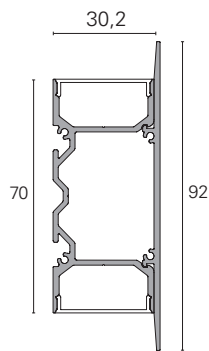

Installazione / Installation

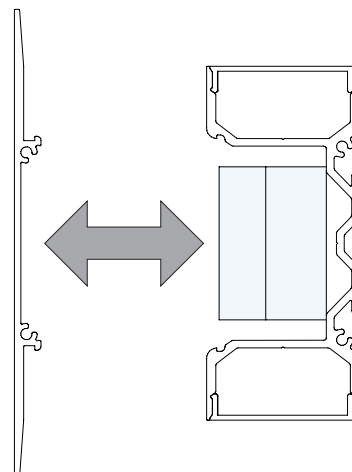
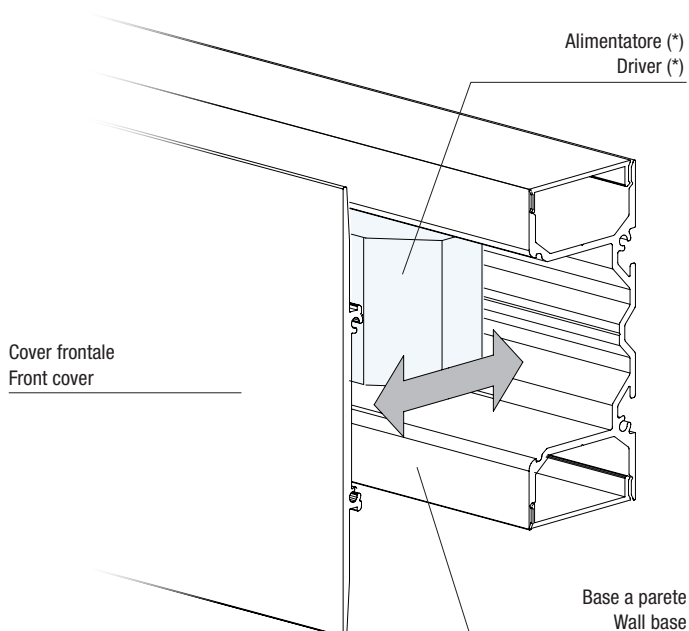

(*) Dimensioni massime dell'alimentatore L=<1800; W=30,5; H=21,5
(*) Driver max dimension L=<1800; W=30,5; H=21,5



STRIPLED

11

La costante innovazione tecnologica offre al mercato una gamma di prodotti estremamente efficienti ed in linea con la più aggiornata produzione industriale in ambito Stripled. I nostri fornitori, accuratamente selezionati, garantiscono il costante miglioramento e mantenimento dei più alti standard qualitativi e d'efficienza. Siamo particolarmente sensibili alla tecnologia ed alla ricerca, all'attento controllo del processo di produzione nonché le più ampie garanzie sull'intera filiera produttiva. Il rispetto di queste regole ci ha permesso di raccogliere validi successi commerciali e presentare una rinnovata gamma di stripled allineate alle ultime novità in questa speciale sezione di mercato.

Le STRIPLED del nostro catalogo sono equipaggiate con led ad alta efficienza dalle ridotte dimensioni e sono tagliabili secondo la circuitazione lungo le predisposizioni indicate. Con un ampio range di potenze e di emissioni luminose, l'efficacia luminosa raggiunge i 180 lm/W con CRI > 90. Sono alimentate a 24V e realizzate nelle configurazioni IP20, IP65 e IP67, Tunable, ed RGB+3000K.

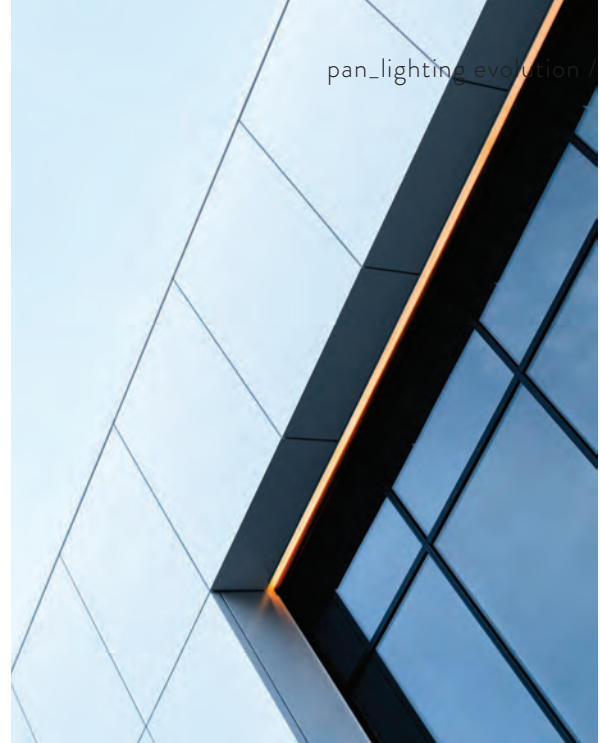

Constant technological innovation allows us to offer an extremely efficient product range in line with the most up-to-date industrial production in the field of LED Strips. Our carefully selected suppliers guarantee constant improvement and maintenance of the highest quality and efficiency standards. We are particularly sensitive to technology and research, we carefully follow the production process with particular attention to the entire production chain. The full respect of these rules has allowed us to obtain real commercial success and to launch a renewed range of LED strips aligned with the latest innovations in this special market section. All our proposal include high-efficiency LEDs with reduced dimensions and can be cut, according to the circuit, as indicated. With a wide range of powers and light emissions, the luminous efficacy reaches 100 lm / W with CRI > 90. They are powered at 24V available in IP20, IP65 and IP67, Tunable, and RGB+3000K technology.





“Quality first” IPC-A-610

I nostri prodotti attraversano diverse fasi prima della messa in commercio. Si effettuano test funzionali a temperature differenziate (-40*/+65*), test sulla presenza di umidità, cicli di accensione e spegnimento, di resistenza sulla circuitazione (Twist & bending Test), controllo sui falsi contatti e sulla resistenza all'invecchiamento (aging test), controllo sulla resistenza all'acqua (grado IP). Tutti questi processi sono indicati e registrati dal ciclo produttivo e disponibili per controllo finale. L'assemblaggio elettronico avviene in accordo all'IPC-A610E standard (Idoneità degli assemblaggi elettronici sulla base dello standard IPC ampiamente utilizzato IPC-A-610).

Our products go through different phases before being put on the market. Functional tests are carried out at different temperatures (-40 * / + 65 *) such as humidity tests , on/off cycles tests, twist & bending tests, false contact tests, aging tests and IP degree tests. All these test results are indicated and recorded by the production process and available for final inspection. Electronic assembly is carried out in accordance with IPC-A610E standard regulations.

(*) La garanzia è valida solo se la Striped è installata su superficie alluminio idonea a garantire la corretta dissipazione del calore.
 (*) Warranty is valid only if the Striped are mounted on an aluminium heat-dissipating surface.



I N D O O R

A glowing, curved strip of light, possibly a flexible LED strip, is the central focus of the image. It curves from the bottom left towards the top right, then loops back down towards the bottom right. The light is a warm, golden-yellow color. The background is solid black. The word 'INDOOOR' is written in white, spaced-out, capital letters across the middle of the glowing strip. The strip has some faint, repeating text on it, which appears to be 'INDOOOR' and some numbers like '+24V'.



CoB LINE

 24 V DC UP TO 91 lm/W CRI > 90 5^{ROLL}m. **3M** 3 YEARS WARRANTY

Le striped della serie CoB Line aiutano nella soluzione dei problemi estetici dovuti alla puntinatura luminosa. La particolare struttura costruttiva della CoB evidenzia una linea continua di luce, senza alcuna interruzione dovuta a puntinatura. Le versioni con sezione da 4 mm. sono perfettamente compatibili con i profili in alluminio della serie MICRO. Questo abbinamento permette di realizzare linee di luce sottilissime, performanti e senza interruzioni di flusso. L'utilizzo è particolarmente semplificato anche per il taglio a misura. Le indicazioni riportate sul PCB facilitano le operazioni di messa in opera.

The striped of the CoB line series helps in solving aesthetic problems due to the bright "dot". The particular construction of the CoB highlights a continuous line of light, without any interruption due to "dot". The 4 mm. versions are perfectly compatible with the MICRO series aluminium profiles. This combination allows you to create very thin lines of light, performing and without interruptions of flow. The use is also particularly simplified for custom cutting. The indications on the PCB make easier the installation operations.

CoB Line_Striped

size	power	code	CCT	lm/m.	lm/W.	LED model	CRI > 90
4 mm. IP20	8 W/m	STP30101	2700 K	664	83	CoB linear	
		STP30102	3000 K	680	85	CoB linear	
		STP30103	4000 K	728	91	CoB linear	

CoB Line_Striped

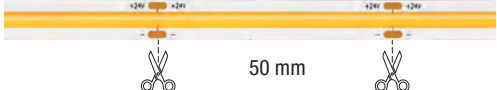
size	power	code	CCT	lm/m.	lm/W.	LED model	CRI > 90
8 mm. IP20	10 W/m	STP30151	2700 K	996	83	CoB linear	
		STP30152	3000 K	1020	85	CoB linear	
		STP30153	4000 K	1092	91	CoB linear	

(*) La garanzia è valida solo se la Striped è installata su superficie alluminio idonea a garantire la corretta dissipazione del calore.

(*) Warranty is valid only if the Striped are mounted on an aluminium heat-dissipating surface.



CoB EVO



24 V DC UP TO **104 lm /W** **CRI > 90** 5^{ROLL}m. **3M** 3 YEARS WARRANTY

Nuovi sistemi produttivi indotti dallo sviluppo tecnologico ampliano potenzialità e qualità nel mondo CoB - STRIP. La strip CoB EVO migliora le qualità del prodotto tradizionale attraverso un processo produttivo innovativo. Il chip led viene collegato direttamente al substrato da sistemi automatici. Questo metodo include una seconda fase che permette l'immediata estrusione dell'intera strip led. Non si è più soggetti al processo di erogazione semiautomatico della colla. Migliora la resistenza meccanica del prodotto, stabilità ed uniformità dei flussi luminosi sono ai massimi livelli per qualità e durata nel tempo.

New production systems induced by technological development expand potential and quality in the CoB -STRIP LED. The CoB EVO strip improves the quality of traditional product through an innovative production process. The LED chip is connected directly to the substrate by automatic systems. This method includes a second phase that allows the immediate extrusion of the entire strip led. You are no longer subject to the semi-automatic glue dispensing process. Improves the mechanical strength of the product, stability and uniformity of the luminous fluxes are at the highest levels for quality and durability

CoB EVO_Stripled

size	power	code	CCT	lm/m.	lm/W.	LED model
8 mm. IP20	10 W/m	STP61243	2700 K	925	93	CoB linear
	320 LED/m	STP61244	3000 K	975	98	CoB linear
		STP61245	4000 K	1030	103	CoB linear
8 mm. IP20	14,4 W/m	STP61253	2700 K	1365	95	CoB linear
	480 LED/m	STP61254	3000 K	1440	100	CoB linear
		STP61255	4000 K	1490	104	CoB linear

CRI > 90



(*) La garanzia è valida solo se la Stripled è installata su superficie alluminio idonea a garantire la corretta dissipazione del calore.

(*) Warranty is valid only if the Stripled are mounted on an aluminium heat-dissipating surface.

MINI STRIPLED

◆ 24 V DC ^{UP TO} 119 lm/W CRI > 90 5^{ROLL}m. **3M** 5 YEARS WARRANTY

La costante crescita tecnologica propone continuamente nuove soluzioni utili nella progettazione illuminotecnica. LED di dimensioni minimali trovano spazio su un PCB di 4 - 5mm e nascono strip ad altissime prestazioni ma con ingombri complessivi estremamente ridotti. L'ideale abbinamento è con i profili della serie Micro, che si contraddistinguono per dimensioni ridotte garanzia di installazioni minimali e performanti. La versione "SINGLE CUT" offre la possibilità di taglio in corrispondenza del singolo LED. Questo permette un perfetto rispetto dimensionale all'interno del profilo limitando al massimo le zone d'ombra.

The constant technological growth constantly offers new useful solutions in lighting design. LED with minimal dimensions find space on a PCB 4 - 5mm. As result we propose high performance strips with extremely small overall dimensions. The ideal combination is with the profiles of the Micro series: micro dimensions, as guarantee of minimal and performing installations. The "SINGLE CUT" version offers the possibility of cutting at the single LED. This allows a perfect dimensional respect inside the profile limiting the shadow zones.

Mini_Stripled

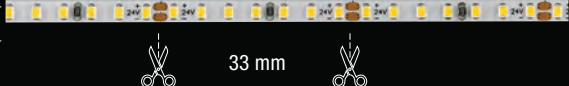
size	power	code	CCT	lm/m.	lm/W.	LED model	CRI > 90
4 mm.	14,4 W/m	STP11153	2700 K	1520	106	2216	
IP20	210 LED/m	STP11154	3000 K	1600	111	2216	
		STP11155	4000 K	1680	117	2216	



(*) La garanzia è valida solo se la Stripled è installata su superficie alluminio idonea a garantire la corretta dissipazione del calore.

(*) Warranty is valid only if the Stripled are mounted on an aluminium heat-dissipating surface.



Mini_Stripled Single Cut

size	power	code	CCT	lm/m.	lm/W.	LED model
4 mm.	8 W/m	STP11523	2700 K	860	108	2216
IP20	168 LED/m	STP11524	3000 K	911	114	2216
		STP11525	4000 K	950	119	2216

CRI > 90



5,95 mm

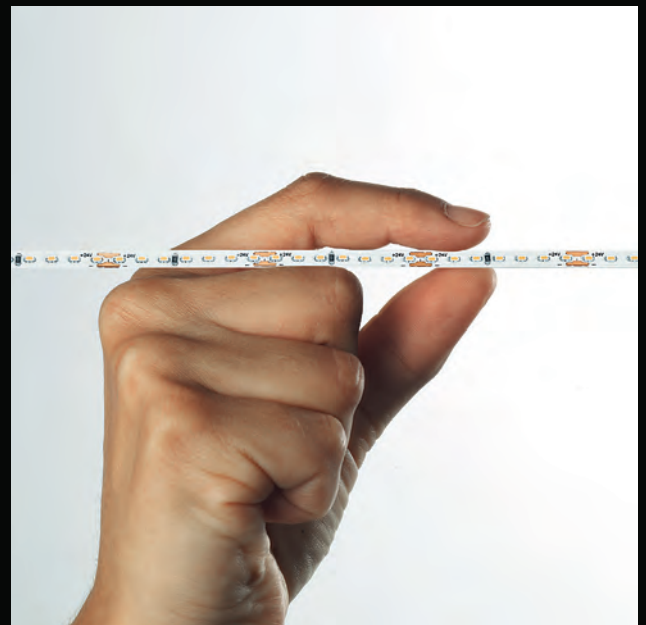



LIGHT LINE STRIPLED

24 V DC UP TO **135 lm/W** **CRI > 90** **5m.** ^{ROLL} **3M** **5 YEARS WARRANTY**

Grazie ai LED di ultima generazione, caratterizzati dalle altissime efficienze e dagli ingombri ridottissimi, la serie Light Line permette di ottenere linee di luce performanti ed affidabili. Con un package compatto e solido e con punti di saldatura rinforzati dati dalle linee di montaggio di ultima generazione, Striped Light Line restituisce potenza, efficienza, qualità cromatica di alto livello, affidabilità e perfetta dissipazione per un impiego altamente professionale

Thanks to the latest generation LEDs, characterized by extremely high efficiency and very small dimensions, the Light Line series allows you to obtain ideal light lines. With a compact and solid package and reinforced welding points provided by the latest generation assembly lines, Striped Light Line returns power, efficiency, high level color quality, reliability and perfect dissipation for highly professional use.

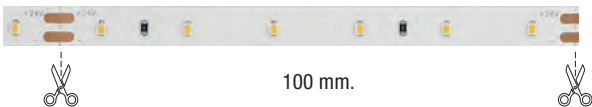
Light Line_Striped 24V DC

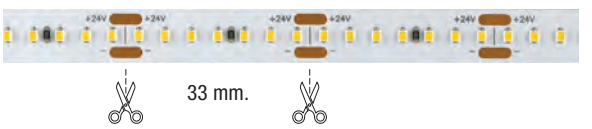
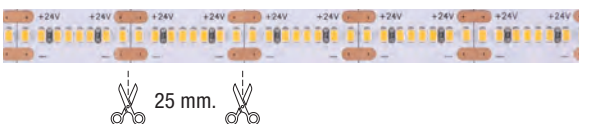
size	power	code	CCT	lm/m.	lm/W.	LED model	CRI > 90
8 mm. IP20	4,8 W/m 60 LED/m	STP20101	2700 K	420	88	2216	
		STP20102	3000 K	450	94	2216	
		STP20103	4000 K	480	100	2216	
9,6 W/m 140 LED/m		STP31231	2200 K	700	73	2216	
		STP31232	2500 K	750	78	2216	
		STP31233	2700 K	1000	104	2216	
		STP31234	3000 K	1100	115	2216	
		STP31235	4000 K	1150	120	2216	
10 mm. IP20	14,4 W/m 210 LED/m	STP31351	2200 K	1440	100	2216	
		STP31352	2500 K	1480	103	2216	
		STP31353	2700 K	1520	106	2216	
		STP31354	3000 K	1600	111	2216	
		STP31355	4000 K	1680	117	2216	
19,2 W/m 320 LED/m		STP31363	2700 K	2300	120	2216	
		STP31364	3000 K	2482	129	2216	
		STP31365	4000 K	2600	135	2216	

(* La garanzia è valida solo se la Striped è installata su superficie alluminio idonea a garantire la corretta dissipazione del calore.

(* Warranty is valid only if the Striped are mounted on an aluminium heat-dissipating surface.





HIGH EFFICIENCY STRIPLED

◆ 24 V DC ^{UP TO} 182 lm/W CRI > 90 5^{ROLL}m. **3M** 5 YEARS WARRANTY

L'impiego di un nuovo e particolare package ha permesso la creazione delle High Efficiency Striped, la soluzione ideale per linee di luce ad elevatissima efficienza luminosa. Il già noto e collaudato emitter 2835 trova nuova vita in questa formula innovativa che raccoglie e sintetizza le eccellenze dei materiali di ultima generazione. Le High Efficiency Striped offrono elevati rendimenti che si combinano con una ottima resa cromatica che si mantiene sempre a livelli di eccellenza. L'impiego di queste strip è indicato nei grandi spazi, nelle applicazioni con luce indiretta oppure dove si richiedono un attento controllo dei costi senza rinunciare alla massima qualità della luce.

A new peculiar package has allowed the creation of High Efficiency Striped, the ideal solution for lines of light with very high luminous efficiency. The already known 2835 emitter finds new life in this innovative formula that collects and synthesizes the excellence of the latest generation materials. The High Efficiency Striped offer high performances combined to an excellent color rendering that always guarantees excellent levels. The use of these strips is indicated in large spaces, in applications with indirect light or where careful cost control is required without having to give up the maximum quality of light.

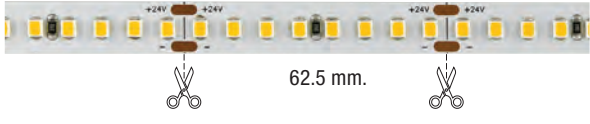
High Efficiency_Striped

size	power	code	CCT	lm/m.	lm/W.	LED model	CRI >90
10 mm. IP20	9,6 W/m 70 LED/m	STP41333	2700 K	1030	107	2835	
		STP41334	3000 K	1088	113	2835	
		STP41335	4000 K	1150	120	2835	
10 mm. IP20	9,6 W/m 128 LED/m	STP71334	3000 K	1680	175	2835	
		STP71335	4000 K	1743	182	2835	
10 mm. IP20	14,4 W/m 80 LED/m	STP10050	2700 K	1750	122	2835	
		STP10051	3000 K	1814	126	2835	
		STP10052	4000 K	1900	132	2835	
10 mm. IP20	14,4 W/m 160 LED/m	STP71354	3000 K	2468	171	2835	
		STP71355	4000 K	2573	178	2835	

(*) La garanzia è valida solo se la Striped è installata su superficie alluminio idonea a garantire la corretta dissipazione del calore.
 (*) Warranty is valid only if the Striped are mounted on an aluminium heat-dissipating surface.



High Efficiency_Stripled

CRI >90

size	power	code	CCT	lm/m.	lm/W.	LED model
10 mm. IP20	19,2 W/m 160 LED/m	STP41363	2700 K	2250	117	2835
		STP41364	3000 K	2386	124	2835
		STP41365	4000 K	2500	130	2835



19,2 W/m 160 LED/m	STP71364	3000 K	3255	170	2835
	STP71365	4000 K	3402	177	2835

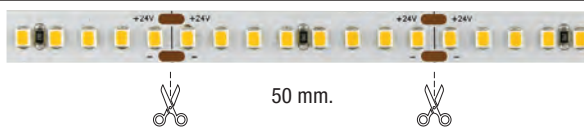

10 mm. IP20	24 W/m 160 LED/m	STP10055	2700 K	2900	121	2835
		STP10056	3000 K	3025	126	2835
		STP10057	4000 K	3200	133	2835



COLOR QUALITY STRIPLED



24 V DC

UP TO

113 lm / W

CRI > 95

5^{ROLL}m.

3M

5 YEARS
WARRANTY

La serie Color Quality Striped si caratterizza per l'elevato standard di resa cromatica. È indicata per applicazioni particolari dove si richiede la perfetta restituzione dei colori; l'apprezzamento dei colori è garantito dall'ottimale miscelazione del flusso emesso dai singoli emitter, senza che venga così penalizzata l'efficacia luminosa che rimane sempre su livelli di eccellenza. Questo connubio rende le Color Quality Striped perfette per installazioni nelle vetrine dei negozi, all'interno di show rooms, oppure per applicazioni in ambito museale.

The Color Quality Striped series is characterized by the high standard of color rendering. It is indicated for particular applications where perfect colors are required; the appreciation of the colors is guaranteed by the optimal mixing of the flow emitted by the individual emitters, without thus affecting the luminous efficacy which always remains at excellent levels. This combination makes the Color Quality Striped the perfect choice for installations in shop windows, inside show rooms, or for museum applications.

Color Quality_Stripled 24V DC

size	power	code	CCT	lm/m.	lm/W.	LED model
10 mm. IP20	14,4 W/m 80 LED/m	STP10040	2700K	1440	100	2835
		STP10041	3000K	1483	103	2835
		STP10042	4000K	1555	108	2835

CRI >95

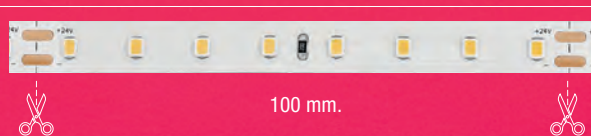

24 W/m 160 LED/m	STP10045	2700K	2448	102	2835
	STP10046	3000K	2668	107	2835
	STP10047	4000K	2712	113	2835

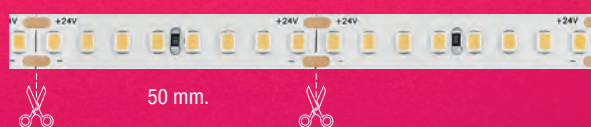

(*) La garanzia è valida solo se la Stripled è installata su superficie alluminio idonea a garantire la corretta dissipazione del calore.

(*) Warranty is valid only if the Stripled are mounted on an aluminium heat-dissipating surface.

TUNABLE STRIPLED



24 V DC **2700÷5000 K** **5^{ROLL}m.** **3M** **5 YEARS WARRANTY**

Le Stripled a colore dinamico presentano contenuti tecnologici all'avanguardia: dotate di circuitazione separata che permette la miscelazione del flusso luminoso, permettono di ottenere infinite variabili cromatiche nel colore bianco. La scala di temperatura di colore può variare tra 2700 K e 5000 K con una fluida transizione attraverso l'universo delle miscele intermedie.

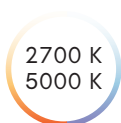
The dynamic chlorinated Stripled have cutting-edge technological contents: equipped with separate circuits that allow the mixing of the luminous flux, they allow to obtain infinite chromatic variables in the white color. The color temperature scale can vary between 2700 K and 5000 K with a gradual transition through the universe of intermediate mixtures.

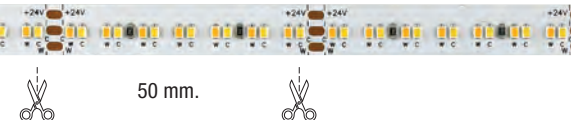

Tunable_Stripled 24V DC

size	power	code	CCT	lm/m.	LED type	
8 mm. IP20	9,6 W/m 120 LED/m	STP21005	2700-5000 K	465-530 lm	2216	
10 mm. IP20	19,2 W/m 280 LED/m	STP31366	2700-5000 K	1090-1230 lm	2216	

(*) La garanzia è valida solo se la Stripled è installata su superficie alluminio idonea a garantire la corretta dissipazione del calore.

(*) Warranty is valid only if the Stripled are mounted on an aluminium heat-dissipating surface.



RGB+3000K STRIPLED



III 24 V DC 5^{ROLL}m. 3M 5 YEARS WARRANTY

Per il miglioramento delle colorazioni ottenibili con strip RGB si inserisce un Led 3000K insieme al modello RGB. Il risultato si riassume in una perfetta miscelazione del colore ed una percezione cromatica senza incertezze. Ottima la gestione del colore bianco visto l'impiego di un LED dedicato.

To improve the colors obtainable with RGB strips, a 3000K LED is inserted with the RGB model. The result is a perfect color mixing and a chromatic perception without uncertainty. Excellent white color management given the use of a dedicated LED.



RGB+3000K_Stripled 24V DC

size	power	code	CCT	lm/m.	lm/W.	LED model
10 mm. IP20	14,4 W/m 168 LED/m	STP31358	RGB + 3000K	/	/	2835
						
	19,2 W/m 168 LED/m	STP31468	RGB + 3000K	/	/	2835
						





O U T D O O R

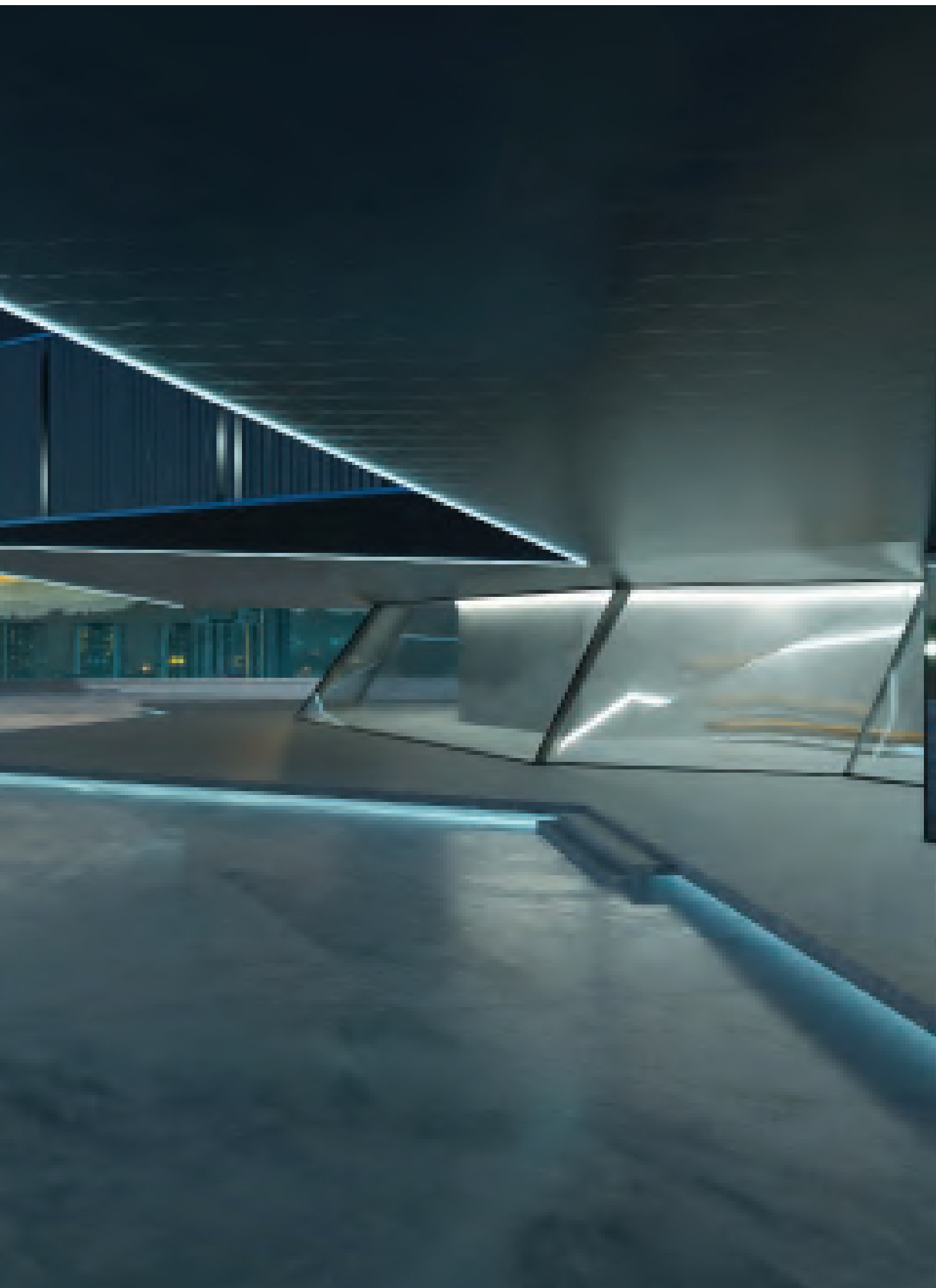

NEON FLEX 2.0

◆ 24 V DC 5^{ROLL}m. 3 YEARS WARRANTY

La linea di sistemi luminosi "NEON FLEX 2.0" semplifica le installazioni decorative in interni ed esterni. L'estrusione in silicone è ottenuta con processi avanzati ed efficienti, pienamente compatibili con il rispetto ambientale. L'alta qualità dei materiali impiegati garantisce miglior resistenza all'invecchiamento rispetto ad altre tipologie di uso comune. Disponibile in 3 diverse misure, Mini - Med e Maxi, ha sezione ed emissioni differenziate. Compatta e di facile impiego si adatta all'installazione in interni ed esterni (IP67). Mantiene morbidezza nella curvatura, garantisce forte resistenza agli urti ed agli agenti atmosferici. La versione MINI, (4*8,5mm) si curva lateralmente e si apprezza per la sottilissima linea di luce emessa. Il modello Med (8*8mm) si curva lateralmente e garantisce buoni flussi luminosi. Maxi (16*16mm) è "dual bend" e copre la maggioranza dei campi applicativi. La selezione proposta si apprezza per la finitura satinata della superficie, l'assenza di puntinatura (DOT free) ed il flusso luminoso costante ed omogeneo. Il taglio a misura risulta semplificato ed è facile ripristinare la sigillatura alle infiltrazioni grazie al kit che comprende fine linea e colla siliconica.

The "NEON FLEX 2.0" line simplifies indoor and outdoor decorative installations. Silicone extrusion is obtained with advanced and efficient processes, fully compatible with the environment. The high quality of the materials guarantees better resistance to aging compared to other types of common use. Available in 3 different sizes, Mini - Med and Maxi, has different section and emissions. Compact and easy to use, it is suitable for indoor and outdoor installation (IP67). It maintains softness in the curvature, provides strong resistance to impact and weathering. The MINI version (4*8,5mm) bend sideways and is appreciated for the thin line of light emitted. The Med (8*8mm) model bend laterally and ensures good luminous flux. Maxi (16*16mm) is dual bend and covers most applications. The proposed selection is appreciated for the satin finish of the surface, the absence of pitting (DOT free) and the constant and homogeneous luminous flux. The cut to size is simplified and it is easy to restore the seal to infiltration thanks to the kit that include end cap and siliconic glue.



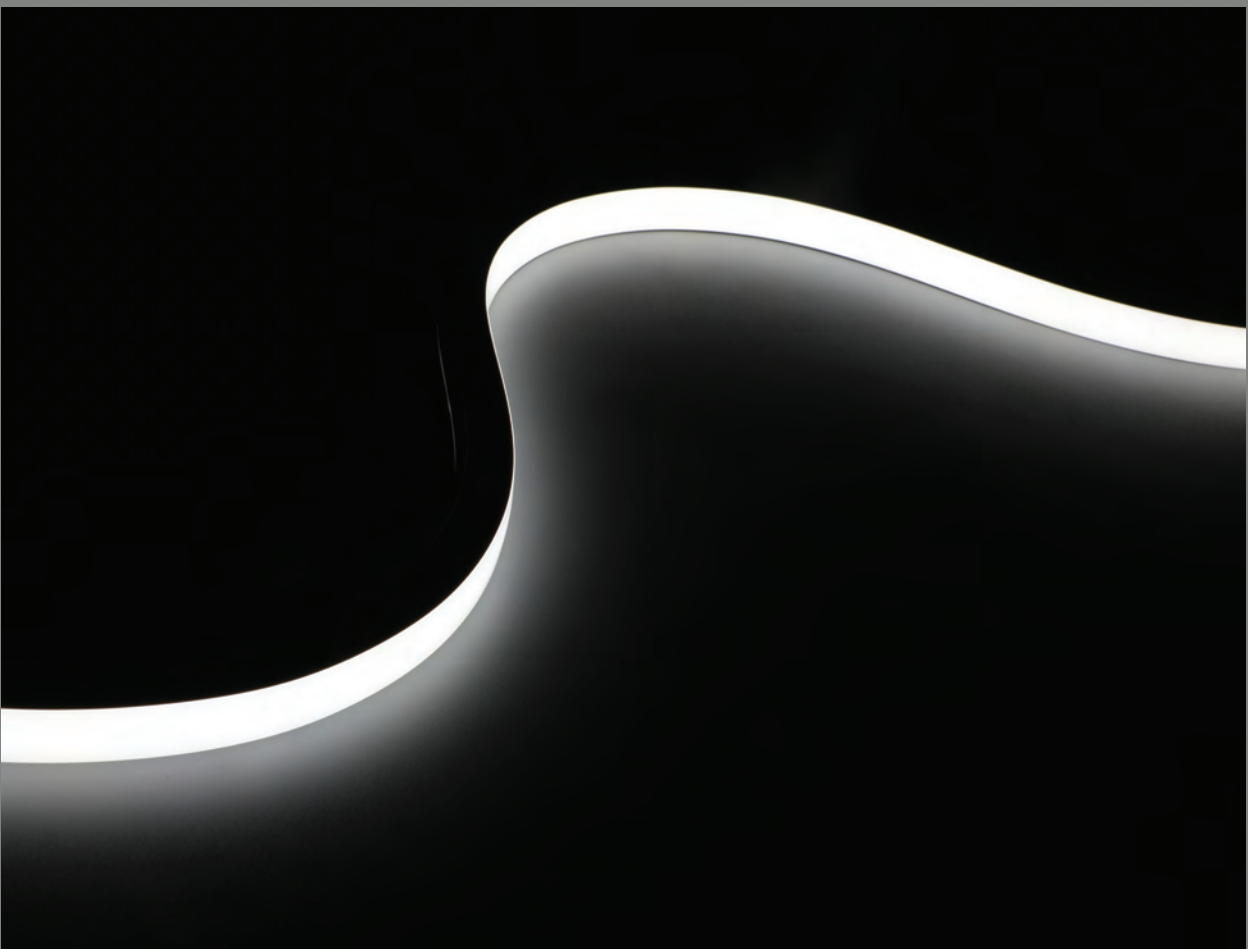



NEON FLEX 2.0

24 V DC UP TO **113 lm/W** **5m.** ^{ROLL} **3M** **3 YEARS WARRANTY**

IP67

Mini Neon Flex 2.0

size	power	code	CCT	lm/m.	lm/W.	LED model	Bending	Bend Radius		CRI > 80
4x8,5 mm.	9 W/m	STP84643	2700 K	210	23	2216	Side			
	240 LED/m	STP84644	3000 K	230	26	2216	Side			
		STP84645	4000 K	240	27	2216	Side			



Accessories

Description	code
-------------	------

Cable feeding unit 300 mm - 2 end caps - Silicon glue	STP80001
---	-----------------



Med Neon Flex 2.0

size	power	code	CCT	lm/m.	lm/W.	LED model	Bending	Bend Radius		CRI > 80
8x8 mm.	8 W/m	STP82743	2700 K	320	36	2216	Side			
	226 LED/m	STP82744	3000 K	330	37	2216	Side			
		STP82745	4000 K	350	39	2216	Side			

Accessories

Description	code
-------------	------

Cable feeding unit 300 mm - 2 end caps - Silicon glue	STP80002
---	-----------------

Aluminium profile 1000 mm	PR09001
---------------------------	----------------



Clips 2 pcs	STP80003
-------------	-----------------

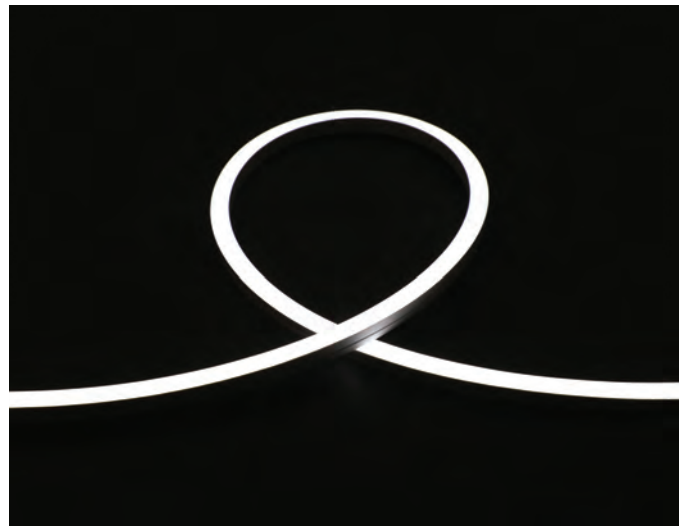

Maxi Neon Flex 2.0

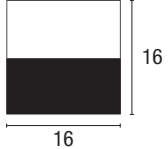
size	power	code	CCT	lm/m.	lm/W.	LED model	Bending	Cut	Bend Radius	CRI > 80
16x16 mm.	14 W/m	STP83853	2700 K	760	54	2835	Dual	Free cut		
	120 LED/m	STP83854	3000 K	800	57	2835	Dual			
		STP83855	4000 K	840	60	2835	Dual			
		STP83857	RGB	/	/	/	2835	Dual		

Accessories

Description	code
Cable feeding unit 300 mm - 2 end caps - Silicon glue for 2700K - 3000K - 4000K	STP80004
Cable feeding unit for RGB 300 mm - 2 end caps - Silicon glue	STP80005
Aluminium profile 1000 mm	PR09006
Bendable profile 1000 mm	PR09007
Clips 2 pcs	STP80006

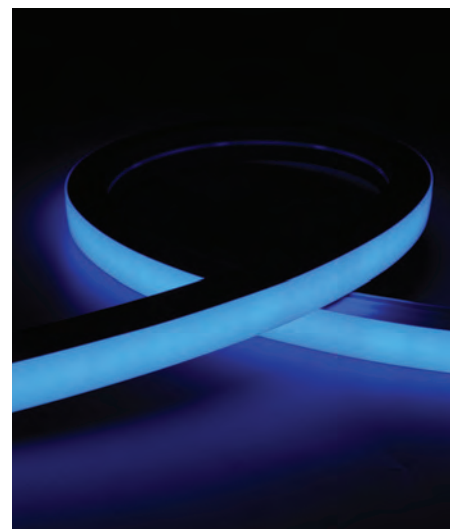
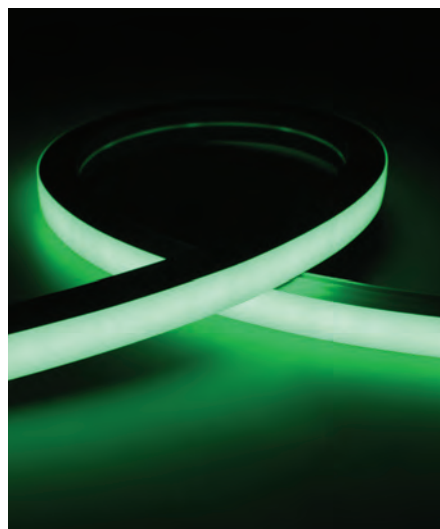



LIGHT LINE WATERPROOF STRIPLED

24 V DC UP TO **128 lm / W** **5m.** ^{ROLL} **3M** **5 YEARS WARRANTY**

La serie Waterproof completa la gamma Striped Light Line con le versioni IP65 e IP67, utilizzabili sia in interni che in esterni. Le versioni con IP65 si prestano facilmente all'utilizzo in interni perchè resistono alla polvere e favoriscono il mantenimento di una perfetta pulizia della strip. I modelli con grado di protezione superiore sono racchiusi in un involucro in silicone che garantisce una perfetta tenuta all'acqua e non altera la qualità dell'emissione luminosa.

IP65

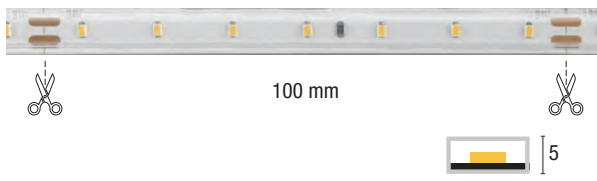
Light Line Waterproof_Striped 24V DC

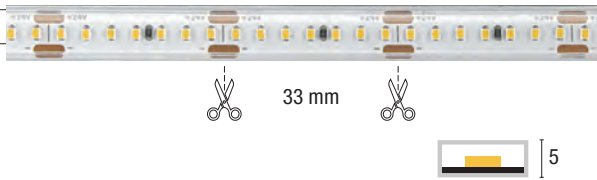
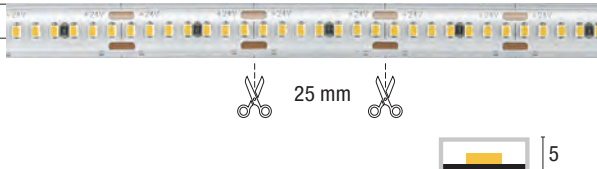
size	power	code	CCT	lm/m.	lm/W.	LED model	CRI > 90
10 mm. IP65	4,8 W/m	STP32314	3000 K	565	118	2216	
	70 LED/m	STP32315	4000 K	600	125	2216	
	9,6 W/m	STP32333	2700 K	890	93	2216	
	140 LED/m	STP32334	3000 K	900	94	2216	
		STP32335	4000 K	960	100	2216	
12 mm. IP65	14,4 W/m	STP32453	2700 K	1450	101	2216	
	210 LED/m	STP32454	3000 K	1520	106	2216	
		STP32455	4000 K	1600	111	2216	
	19,2 W/m	STP32463	2700 K	1840	96	2216	
	280 LED/m	STP32464	3000 K	1860	97	2216	
		STP32465	4000 K	1960	102	2216	

(*) La garanzia è valida solo se la Striped è installata su superficie alluminio idonea a garantire la corretta dissipazione del calore.



(*) Warranty is valid only if the Striped are mounted on an aluminium heat-dissipating surface.

The Waterproof serie completes the Striped Light Line range with the different IP65 and IP67 versions, useful also per indoor installations. The versions with IP65 are ideal for indoor use. They are dust-resistant and easy to be kept clean. The versions with a higher degree of protection are encased in a silicone casing which guarantees perfect water tightness without altering the quality of the light emission.

IP67

Light Line Waterproof_Striped 24V DC

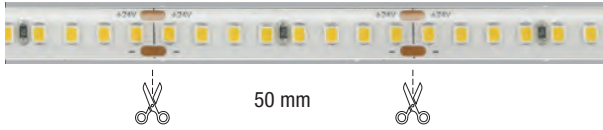
size	power	code	CCT	lm/m.	lm/W.	LED model	CRI > 90
10 mm.	9,6 W/m	STP33334	3000 K	1000	104	2835	
IP67	140 LED/m	STP33335	4000 K	1050	109	2835	

12 mm.	14,4 W/m	STP33454	3000 K	1750	122	2835	
IP67	160 LED/m	STP33455	4000 K	1850	128	2835	
	19,2 W/m	STP33464	3000 K	2215	115	2835	
	160 LED/m	STP33465	4000 K	2320	121	2835	

(*) La garanzia è valida solo se la Striped è installata su superficie alluminio idonea a garantire la corretta dissipazione del calore.
 (*) Warranty is valid only if the Striped are mounted on an aluminium heat-dissipating surface.

RGB+3000K



24 V DC
5m.
3M
5 YEARS WARRANTY

Per il miglioramento delle colorazioni ottenibili con strip RGB si inserisce un Led 3000K insieme al modello RGB. Il risultato si riassume in una perfetta miscelazione del colore ed una percezione cromatica senza incertezze. Ottima la gestione del colore bianco visto l'impiego di un LED dedicato. Per garantire l'impermeabilità la strip viene alloggiata in una guaina in silicone. Buona resistenza agli urti meccanici ed agenti atmosferici. La qualità dei materiali non altera la resa cromatica del colore.

IP65

RGB+3000K_Striped 24V DC

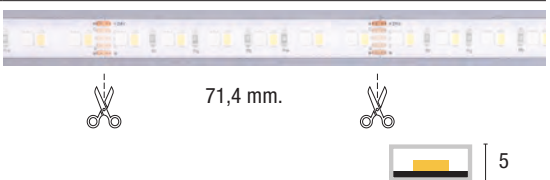
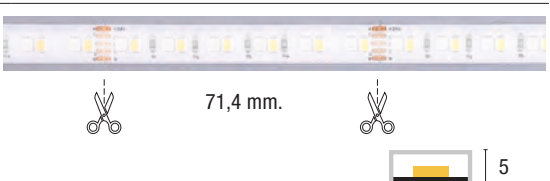

size	power	code	CCT	Lm/m.	Lm/W.	LED model	
12 mm.	14,4 W/m 168 LED/m	STP32581	RGB+3000K	/	/	2835	
19,2 W/m 168 LED/m	STP32881	RGB+3000K	/	/	2835		

(*) La garanzia è valida solo se la Striped è installata su superficie alluminio idonea a garantire la corretta dissipazione del calore.
 (*) Warranty is valid only if the Striped are mounted on an aluminium heat-dissipating surface.

To improve the colors obtainable with RGB strips, a 3000K LED is inserted with the RGB model.

The result is a perfect color mixing and a chromatic perception without uncertainty.

Excellent white color management given the use of a dedicated LED. To ensure water resistance, the strip is housed in a silicone sleeve. Good resistance to mechanical shock and weathering. The quality of the materials does not change the color rendering.

IP67

RGB+3000K_Stripled 24V DC



size	power	code	CCT	Lm/m.	Lm/W.	LED model	
12 mm.	14,4 W/m 168 LED/m	STP33581	RGB+3000K	/	/	2835	
	19,2 W/m 168 LED/m	STP33881	RGB+3000K	/	/	2835	

(*) La garanzia è valida solo se la Stripled è installata su superficie alluminio idonea a garantire la corretta dissipazione del calore.

(*) Warranty is valid only if the Stripled are mounted on an aluminium heat-dissipating surface.



CONTROLLERS AND DRIVERS

12

Casambi_p.502

Tuya_p.504

Monochrome control system_p.508

Tunable control system_p.511

RGB+W control system_p.514

Control systems_p.518





Drivers_p.519

Emergency Kit_p.522

Light Sources_p.524

Sistemi di controllo / Control systems

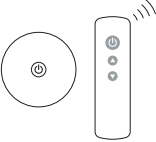
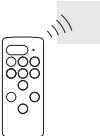
Sistemi di controllo Monocromatici
Monochrome control system

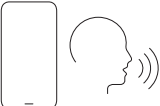
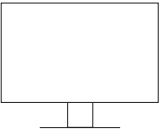
	descrizione description	codice code	codice code	+	opzionale optional	
	PUSH BUTTON	Dimmer control 360 W	DRV8105	+	Remote control DRV8005	
		Dimmer 192 W	DRV8100	+	Remote control DRV8005	
	TOUCH PANEL	Decoder 4x 120 W	DRV8001 DRV8122	+	Remote control DRV8008	
	REMOTE CONTROL	Dimmer control 360 W	DRV8005 DRV8011 DRV8012	+	DRV8105	
		Dimmer 192 W	DRV8100			
	KIT	Dimmer kit 120 W	DRV8201			
	SMARTPHONE BLUETOOTH	Mesh Dimmer 360 W	DRV8210			
		CASAMBI Wireless driver	DRV8311			
		CASAMBI Bluetooth 4ch PWM dimmer	DRV8312			
	SMARTPHONE WI-FI VOICE CONTROL	Dimmer kit 144W	DRV8205			
	MULTI CONTROL	DIN rail Dimmer DALI max. 156 W	DRV9052			
		DALI / Push N.O. / 0...10V - 1...10 Analogical / 1...10V Potentiometer	DIN rail Dimmer DALI max. 480 W	DRV9053		
		DMX / Push N.O. / 0...10V - 1...10 Analogical / 1...10V Potentiometer	DIN rail Dimmer DMX max. 480 W	DRV9054		



Sistemi di controllo Bianco Variabile Tunable control system

Sistemi di controllo RGB+W RGB+W control system

descrizione description	codice code	+	opzionale optional	descrizione description	codice code	+	opzionale optional
Dimmer control 360 W	DRV8110	+	Remote control DRV8006	Dimmer control 4x 180 W	DRV8120	+	Remote control DRV8007
CASAMBI Wireless driver	DRV8311			Dimmer max. 240 W	DRV9008	+	Signal amplifier DRV9009
				CASAMBI Wireless driver	DRV8311		
Decoder 4x 120 W	DRV8002 DRV8122	+	Remote control DRV8009	Decoder 4x 120 W	DRV8003 DRV8122	+	Remote control DRV8010
Dimmer control 360 W	DRV8110	+	Remote control DRV8006	Dimmer control 4x 180 W	DRV8120	+	Remote control DRV8007
	\				\		
Tunable White Dimmer kit 144 W	DRV8203			RGB+W Dimmer kit 192 W	DRV8025		
Tunable Mesh Dimmer 336 W	DRV8212			RGB+W Mesh Dimmer	DRV8215		
CASAMBI Bluetooth 4ch PWM dimmer	DRV8312			CASAMBI Wireless driver	DRV8311		
				CASAMBI Bluetooth 4ch PWM dimmer	DRV8312		
Dimmer kit 192W	DRV8204			Dimmer kit 192W	DRV8220		
				Dimmer control 5x72W	DRV8102		
				Dimmer control max 720W	DRV8115		
	\				\		
	DRV9053				DRV9053		
	DRV9054				DRV9054		



Control systems

Dimmer wireless Bluetooth



controllo <i>control</i>	Smartphone Bluetooth / PUSH
tensione in ingr. <i>voltage range</i>	220 ÷ 240 V
codice <i>code</i>	DRV8311
potenza <i>power</i>	0 ÷ 120 W
corrente in uscita <i>output current</i>	5 A max
tensione in uscita <i>output voltage</i>	3 x 24 Vdc
cl. isolamento / IP <i>insulation class / IP</i>	class I / IP20
misure L - H - P <i>size L - H - P</i>	240 x 60x 49 mm

CASAMBI

Alimentatore elettronico regolabile con uscita in tensione per moduli LED.
 Integra il modulo wireless CASAMBI (RGB)
 Include protezioni termica, cortocircuito, sovratensione rete. Fusibile di protezione all'ingresso.
 Regolazione luminosità 0/1 - 100 % PUSH e APP
 Selezionabili 3 diverse modalità tramite CASAMBI APP:
 Canali indipendenti , Tunable White, RGB.

Dimmable electronic driver with output voltage for LED modules.
 Three outputs for LED modules (RGB) with integrated wireless CASAMBI module
 Protections: against overheating, short circuits, mains voltage spikes, against overloads,
 Protection fuse on main tension.
 Light regulation 0/1 - 100 % PUSH function & CASAMBI APP
 3 different modes selectable via CASAMBI APP: Independent channels mode,
 Tunable White, RGB.

Dimensioni / Dimensions

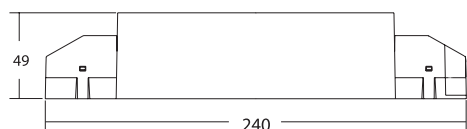
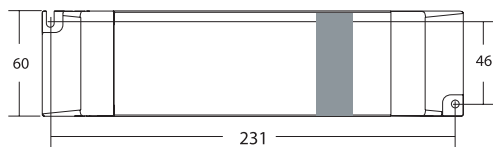

■ Posizione antenna
 Antenna location

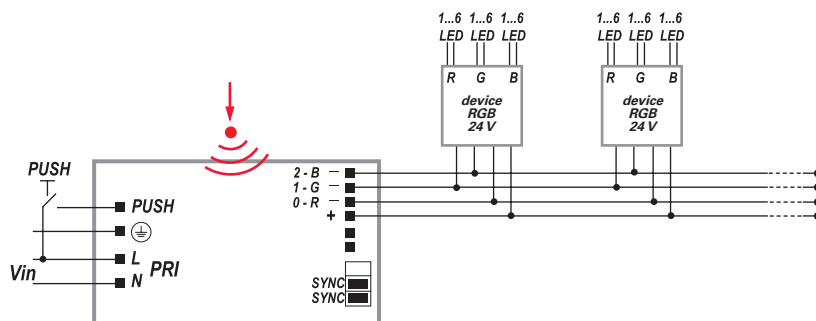

Remote Controllers



misure L - H - P
 size L - H - P

90 x 12 x 90 mm

CASAMBI



L'interruttore Xpress è un'interfaccia utente wireless PER app casambi.
 I quattro pulsanti possono controllare scene, funzioni o apparecchi.
 Il telecomando include pulsanti per controllare temperatura del colore o intensità.
 L'interruttore viene fornito con batteria inclusa e basetta fissaggio a parete.

*The Xpress switch is a Casambi wireless interface.
 The four target buttons can control scenes, animations or luminaires.
 The device include up/down buttons that can either control the colour temperature or output intensity. The switch is supplied with battery included and wall mounting plate.*

descrizione <i>description</i>	colore <i>color</i>	codice <i>code</i>
Massima distanza 50 m. in area aperta <i>50 m. max distance at open area</i>	bianco / white	DRV8306
	nero / black	DRV8307



CASAMBI

Dimmer PWM a quattro canali con controllo Casambi Bluetooth. (RGBW, TW)
Il componente si integra in una rete mesh e controlla un massimo di 127 unità.
Protetto da sovratensione, sovracorrente e corto circuito.

Bluetooth DIMMER, Casambi four channel PWM dimmer (RGBW, TW)
Up to 127 units form automatically an intelligent mesh network.
Protected against overvoltage, overcurrent and short circuit situations.



controllo <i>control</i>	Smartphone Bluetooth
tensione in ingr. <i>voltage range</i>	12 / 24V DC
codice <i>code</i>	DRV8312
potenza <i>power</i>	12 V - 72 W / 24 V - 144 W
corrente in uscita <i>output current</i>	6 A max
tensione in uscita <i>output voltage</i>	V in
cl. isolamento / IP <i>insulation class / IP</i>	class I / IP20
misure L - H - P <i>size L - H - P</i>	72 x 30 x 18 mm

Schema elettrico, RGBW
Wiring diagram, RGBW

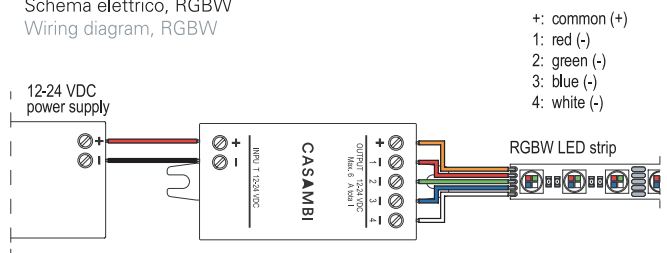

Schema elettrico, tunable white
Wiring diagram, tunable white

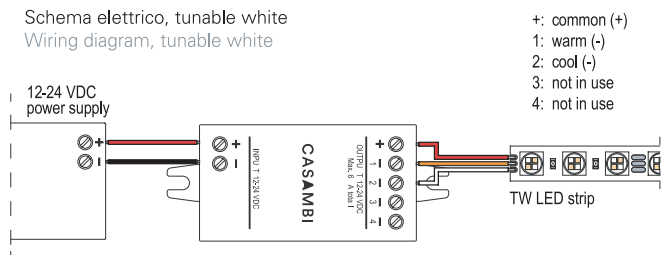

Schema elettrico, 1-4 canali separati
Wiring diagram, 1-4 separate channels

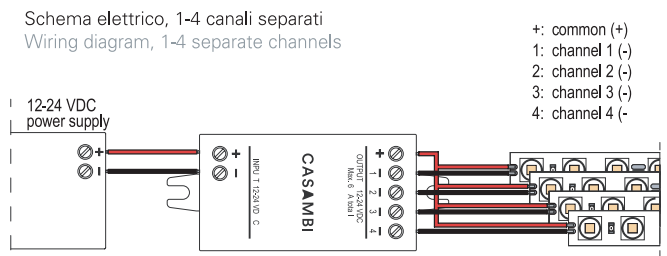

Dimensioni / Dimensions

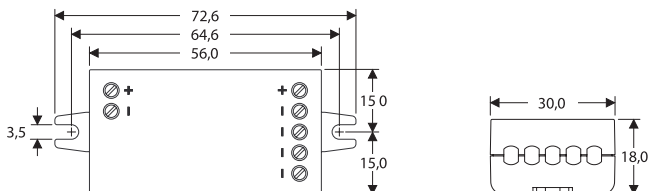

App Link:



Download on the
App Store

ANDROID APP ON
Google play



Monochrome control system



Dimmer Kit



controllo control	Remote control + WI-FI
tensione in ingr. voltage range	24V AC
codice code	DRV8205
potenza power	144 W
corrente in uscita output current	6A
tensione in uscita output voltage	24V DC
cl. isolamento / IP insulation class / IP	class III
misura L - H - P size L - H - P	60 x 20,5 x 9 mm
Remote control distance	>15m at open area

DRV8220 è un dimmer progettato per alimentare lampade LED monocromatiche a tensione costante 24V DC. Può essere controllato tramite l'app Tuya Smart o tramite un telecomando RF portatile (incluso). Controllo vocale con Amazon ALEXA, Google Assistant and Google Home. L'utente può impostare la luminosità del LED, la temperatura del colore e la scena sull'app Tuya per smartphone o sul telecomando di facile utilizzo.

DRV8220 is a dimmer designed to power 24V DC constant voltage monochromatic LED lamps. It can be controlled via Tuya Smart app or via a remote control Portable RF (included). Voice control with Amazon ALEXA, Google Assistant and Google Home. The user can set the LED brightness, colour temperature and scenes on the Tuya app for smartphone or on the easy-to-use remote control.

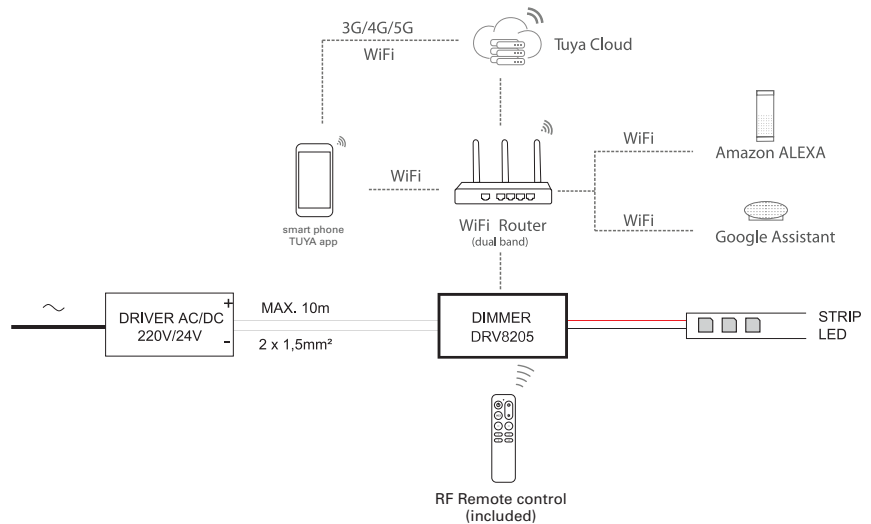

Tunable White control system



Dimmer Kit



controllo control	Remote control + WI-FI
tensione in ingr. voltage range	24V AC
codice code	DRV8204
potenza power	192 W
corrente in uscita output current	2x4A
tensione in uscita output voltage	24V DC
cl. isolamento / IP insulation class / IP	class III
misura L - H - P size L - H - P	60 x 20,5 x 9 mm

DRV8204 è un dimmer progettato per alimentare lampade LED Tunable white a tensione costante 24V DC. Può essere controllato tramite l'app Tuya Smart o tramite un telecomando RF portatile (incluso). Controllo vocale con Amazon ALEXA, Google Assistant and Google Home. L'utente può impostare la luminosità del LED, la temperatura del colore e la scena sull'app Tuya per smartphone o sul telecomando di facile utilizzo.

DRV8204 is a dimmer designed to power 24V DC constant voltage Tunable White LED lamps. It can be controlled via Tuya Smart app or via a remote control Portable RF (included). Voice control with Amazon ALEXA, Google Assistant and Google Home. The user can set the LED brightness, colour temperature and scenes on the Tuya smartphone app or the easy-to-use remote control.

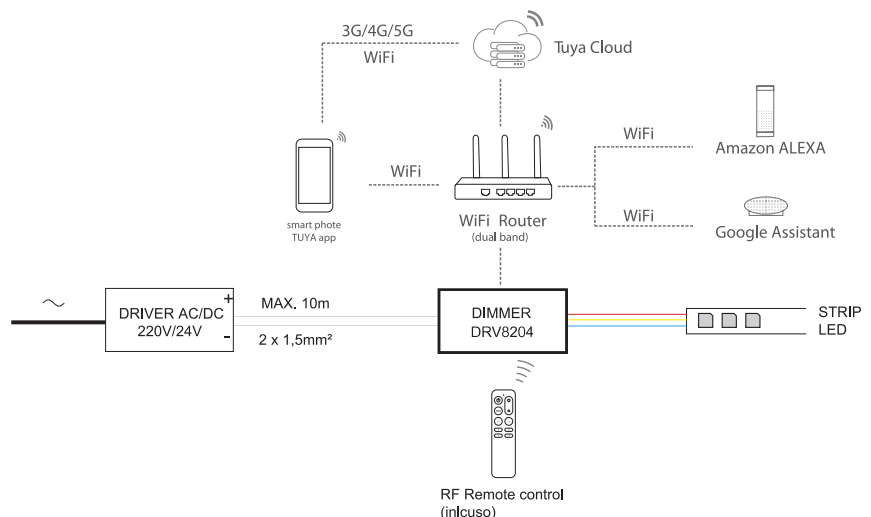

RGB+W control system

Powered by

Intelligence
Inside

RGB+W Dimmer Kit

LED dimmer a 4 canali per lampade LED RGB+W a tensione costante 24V DC. Può essere controllato tramite l'app Tuya Smart o tramite un telecomando RF portatile (incluso). Controllo vocale con Amazon ALEXA, Google Assistant and Google Home. L'utente può impostare la luminosità del LED, la temperatura del colore e la scene sull'app Tuya per smartphone o sul telecomando di facile utilizzo.

4-channel LED dimmer for 24V DC constant voltage RGB+W LED lamps. It can be controlled via the Tuya Smart app or via a remote control Portable RF (included). Voice control with Amazon ALEXA, Google Assistant and Google Home. The user can set the LED brightness, color temperature and scene on the Tuya smartphone app or the easy-to-use remote control.



controllo <i>control</i>	Remote control + WI-FI
tensione in ingr. <i>voltage range</i>	24V AC
codice <i>code</i>	DRV8220
potenza <i>power</i>	192 W
corrente in uscita <i>output current</i>	4x2A
tensione in uscita <i>output voltage</i>	24V DC
cl. isolamento / IP <i>insulation class / IP</i>	class III
misure L - H - P <i>size L - H - P</i>	60 x 20,5 x 9 mm

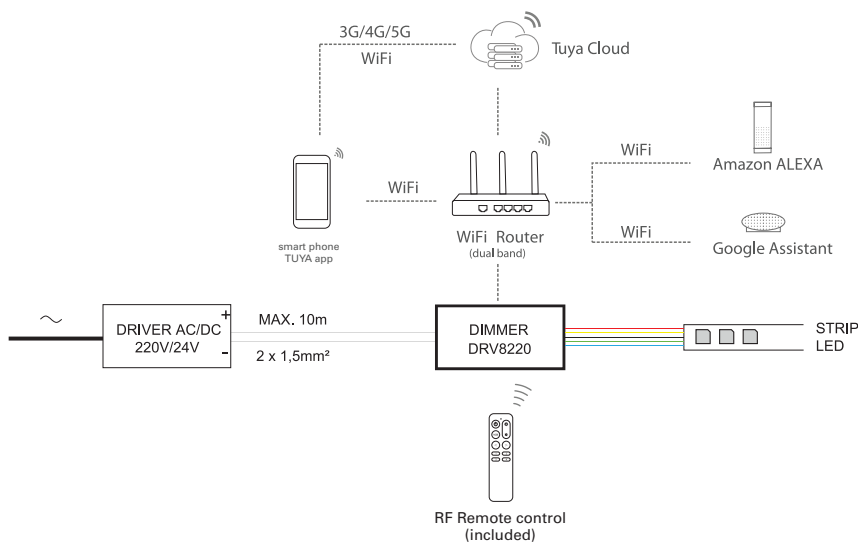

App Link:



Download on the
App Store

ANDROID APP ON
Google play



Control



LED dimmer a 5 canali per lampade RGB, RGBW, RGB+CCT, bianco dinamico o monocromatiche
 LED dimmer con controllo da APP Tuya (mediante cloud) e Radiofrequenza
 APP Tuya: supporta ON/OFF; regolazione del colore e della temperatura di colore; regolazione intensità luminosa; ON/OFF ritardato; temporizzazione; scene; funzione "music play"
 Controllo vocale con Amazon ALEXA, Google Assistant and Google Home.
 Funzione convertitore da segnale WiFi a segnale RF per controllare da APP Tuya, in modo sincrono, altri dispositivi RF come dimmer o alimentatori.
 Controllo radiofrequenza: mediante controlli remoti 2.4GHz. (Tutti i Remote Controller possono essere associati).
 Sincronizzabili con più radiocomandi.



5-channel dimmer LED for RGB, RGBW, RGB+CCT, dynamic white or monochromatic lamps
 LED dimmer with control from APP Tuya (via cloud) and Radiofrequency
 Tuya APP: Support ON/OFF; colour and light temperature adjustment; adjustment light intensity; ON/OFF delayed; timing; scenes; music play Function Voice control with Amazon ALEXA, Google Assistant and Google Home.
 WiFi signal to RF signal converter function to control synchronously by Tuya APP other RF devices such as dimmers or power supplies.
 Radio frequency control: by 2.4GHz remote controls. (All Remote Controllers can be associated.)
 which can be synchronized with multiple remote controls.

controllo control	WI-FI Tuya App
tensione in ingr. voltage range	24V AC
codice code	DRV8102
potenza power	5 x 72W
corrente in uscita output current	5A/CH
tensione in uscita output voltage	V in
cl. isolamento / IP insulation class / IP	class II
misure L - H - P size L - H - P	114 x 38 x 20 mm
Barrier - free space	30m

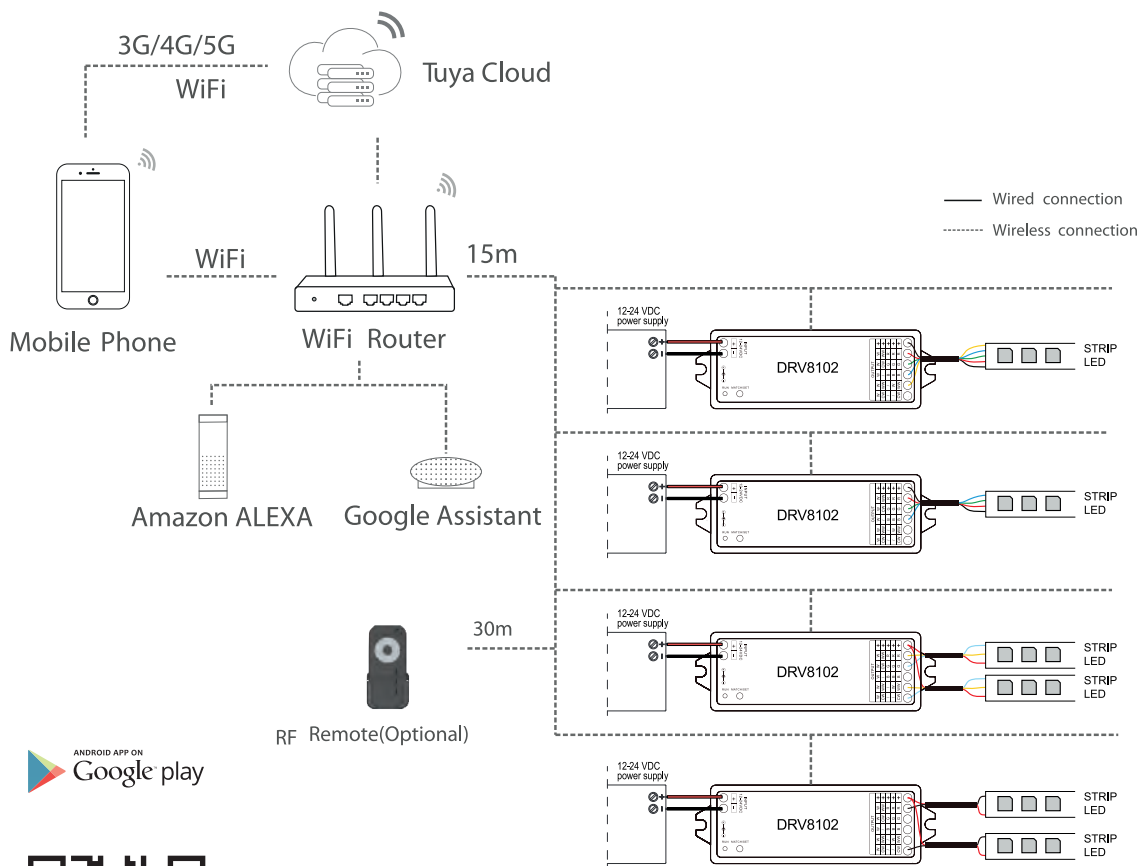

App Link:



Control



LED dimmer a 5 canali per lampade RGB, RGBW, RGB+CCT, bianco dinamico o monocromatiche
 LED dimmer con controllo da APP Tuya (mediante cloud) e Radiofrequenza
 APP Tuya: supporta ON/OFF; regolazione del colore e della temperatura di colore; regolazione intensità luminosa; ON/OFF ritardato; temporizzazione; scene; funzione "music play"
 Controllo vocale con Amazon ALEXA, Google Assistant and Google Home.
 Funzione convertitore da segnale WiFi a segnale RF per controllare da APP Tuya, in modo sincrono, altri dispositivi RF come dimmer o alimentatori.
 Controllo radiofrequenza: mediante controlli remoti 2.4GHz. (Tutti i Remote Controller possono essere associati).
 Sincronizzabili con più radiocomandi.
 Possibilità di utilizzo con pulsante esterno per accensione e regolazione luminosa 0-100%.

5-channel dimmer LED for RGB, RGBW, RGB+CCT, dynamic white or monochromatic lamps
 LED dimmer with control from APP Tuya (via cloud) and Radiofrequency
 Tuya APP: Support ON/OFF; colour and light temperature adjustment; adjustment light intensity; ON/OFF delayed; timing; scenes; music play Function Voice control with Amazon ALEXA, Google Assistant and Google Home.
 WiFi signal to RF signal converter function to control synchronously by Tuya APP other RF devices such as dimmers or power supplies.
 Radio frequency control: by 2.4GHz remote controls. (All Remote Controllers can be associated.)
 which can be synchronized with multiple remote controls.
 Possibility of use with external button for switching on and 0-100% light adjustment.

controllo control	Wi-Fi Tuya App + push
tensione in ingr. voltage range	24V AC
codice code	DRV8115
potenza power	max 720W
corrente in uscita output current	6A/CH
tensione in uscita output voltage	V in
cl. isolamento / IP insulation class / IP	class II
misure L - H - P size L - H - P	179 x 56 x 30 mm

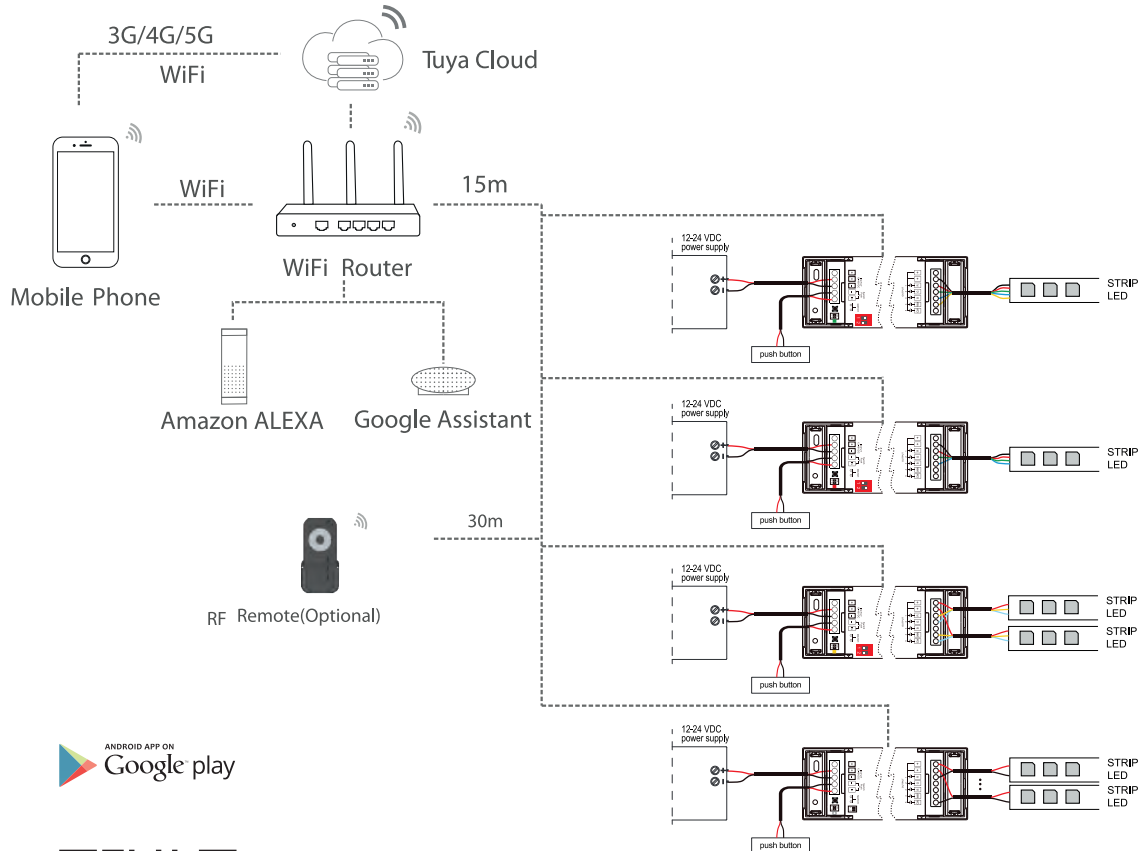

App Link:



Monochrome control system

Touch Panels



controllo <i>control</i>	DMX512, RF 2.4GHz / RF remote control
tensione in ingr. <i>voltage range</i>	85-265V AC
codice <i>code</i>	DRV8001
potenza <i>power</i>	\
corrente in uscita <i>output current</i>	\
tensione in uscita <i>output voltage</i>	\
cl. isolamento / IP <i>insulation class / IP</i>	class II / IP20
misure L - H - P <i>size L - H - P</i>	120 x 80 x 37 mm

Touch Panel capacitivo da parete, frontale in vetro ad alta resistenza. Ultra sensibile con ruota cromatica retroilluminata. Gestisce ON/OFF e regolazione luminosità 1 canale. Selezionabili 4 zone e 10 livelli di luminosità. Uscita segnale DMX conforme al protocollo DMX512 standard, è utilizzabile anche con telecomando remoto DRV8008 (non incluso). L'apparecchio si integra con il decoder DRV8122. Può pilotare fino a 20 decoder. Installabile in scatola parete 503 standard.

Ultra-sensitive capacitive high-resistance glass touch panel, wall application. Backlit color wheel set ON/OFF function and lumen flux 1 channel. 4 separate zones available, 10 different brightness levels. DMX signal output compliant with standard DMX512 protocol, compatible with remote control DRV8008 (not included) and decoder cod. DRV8122. Master up to 20 decoders. Can be installed in a standard 503 wall box.



(*) Scatola a muro 503 standard non inclusa.
(* Standard 503 wall box not included.)

Decoder



controllo <i>control</i>	DMX512
tensione in ingr. <i>voltage range</i>	24V DC
codice <i>code</i>	DRV8122
potenza <i>power</i>	4x 120 W
corrente in uscita <i>output current</i>	4CH, 5A/CH
tensione in uscita <i>output voltage</i>	4 x 24V DC
cl. isolamento / IP <i>insulation class / IP</i>	class II / IP20
misure L - H - P <i>size L - H - P</i>	170 x 50 x 23 mm

Decoder per segnale DMX512. Si integra con DRV8001. Display numerico digitale con pulsanti di settaggio. Gestisce 1,2,3,4 canali. Funzionalità stand-alone. Selezionabile frequenza PWM 2000 / 500Hz e scala dimmer logaritmica o lineare. Max 20 decoder in cascata. Protezione da surriscaldamento / cortocircuito, ripristino automatico.

Decoder for DMX512 signal. Digital numerical display with touch switches setup. Stand-alone RGB / RGBW mode and selectable 4-channel decoder. Accept codes DRV8001. Selectable 2000 / 500Hz PWM frequency. Linear or logarithmic dimmer curve selectable. Max 20 cascadable decoder. Overheat / short circuit protection, automatic reset.

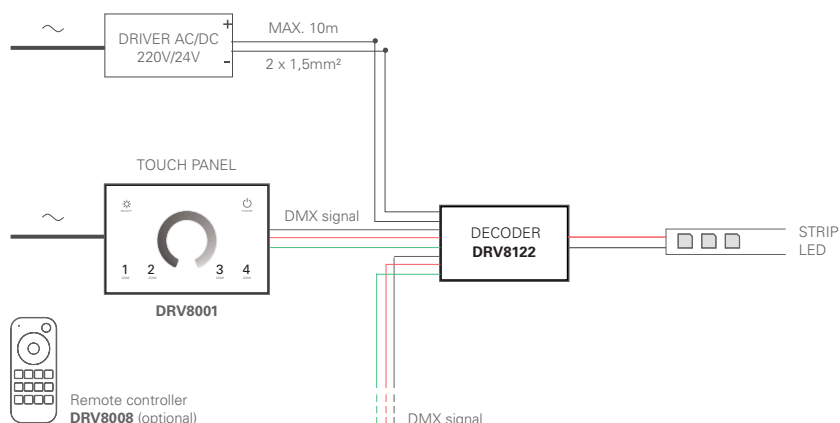

Remote Controller



misure L - H - P <i>size L - H - P</i>	122 x 53 x 17,5 mm
---	--------------------

descrizione
description

Massima distanza 30 m. in area aperta / 30 m. max distance at open area

codice
code

DRV8008

Telecomando soft touch 1 canali a radiofrequenza opzionale per Touch Panel DRV8001. I singoli canali si attivano con leggera pressione sulla scala cromatica posta centralmente. 4 pulsanti dedicati per la selezione dell'intensità (25% / 50% / 75% / 100%). 4 pulsanti dedicati per la selezione delle zone. Fissaggio magnetico su apposita staffa a parete (inclusa). Alimentato a batteria. (non inclusa).

Optional radio frequency soft touch remote control for DRV8001 Touch Panel. Ultra sensitive with a touch color wheel in the center. 4 buttons for brightness selection (25% / 50% / 75% / 100%). 4 buttons for zone selection Magnetic fixing on special wall bracket (included). Battery powered (not included).

Controller



controllo <i>control</i>	RF remote control / Push Dim.
tensione in ingr. <i>voltage range</i>	24V DC
codice <i>code</i>	DRV8105
potenza <i>power</i>	360W
corrente in uscita <i>output current</i>	1CH, 15A
tensione in uscita <i>output voltage</i>	24V DC
cl. isolamento / IP <i>insulation class / IP</i>	class II / IP20
misure L - H - P <i>size L - H - P</i>	175 x 45 x 27 mm



controllo <i>control</i>	RF remote control / Push Dim.
tensione in ingr. <i>voltage range</i>	24V DC
codice <i>code</i>	DRV8100
potenza <i>power</i>	192W
corrente in uscita <i>output current</i>	8A
tensione in uscita <i>output voltage</i>	24V DC
cl. isolamento / IP <i>insulation class / IP</i>	class II / IP20
misure L - H - P <i>size L - H - P</i>	52 x 52 x 26 mm

Dimmer control 1 canale con funzione "push" - ricevitore a radiofrequenza in funzione "push" on. Pulsante esterno comanda accensione e regolazione luminosa. Scala dimmerazione 0-100%, uniforme e progressiva. Max 20 dimmer sincronizzabili. Funzione di trasmissione automatica; trasmette automaticamente il segnale a un altro controller fino a una distanza massima di 30 m. Abbinabile a Telecomando DRV8005 (opzionale). Un Controller accetta fino a 10 telecomandi. Protezione da surriscaldamento / sovraccarico / cortocircuito, ripristino automatico.

Dimmer control with "push" and RF function. Connect with an external switch to achieve switching on / off and 0-100% dimming function. 0-100% dimming, without stroboscopic effect. Synchronize on multiple Dimmer (max 20) . Automatic transmission function; automatic transmission of the signal to another controller up to a maximum distance of 30 m. Can be combined with Remote Control DRV8005 (optional). One Controller accepts up to 10 remote controls. Overheating / overload / short circuit protection, automatic reset

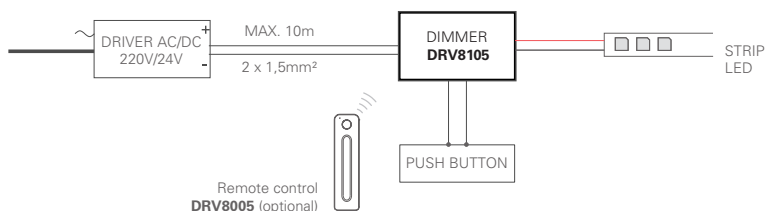

Dimmer control 1 canale con funzione "push" - ricevitore a radiofrequenza in funzione "push" on. Pulsante esterno comanda accensione e regolazione luminosa. Scala dimmerazione 0-100%, uniforme e progressiva. Max 20 dimmer sincronizzabili. Funzione di trasmissione automatica; trasmette automaticamente il segnale a un altro controller fino a una distanza massima di 30 m. Abbinabile a Telecomando DRV8005 (opzionale). Un Controller accetta fino a 10 telecomandi. Protezione da surriscaldamento / sovraccarico / cortocircuito, ripristino automatico. Le ridotte dimensioni lo rendono ideale per alloggiamento in scatole derivazione a parete standard.

Dimmer control with "push" and RF function. Connect with an external switch to achieve switching on / off and 0-100% dimming function. 0-100% dimming, without stroboscopic effect. Synchronize on multiple Dimmer (max 20) . Automatic transmission function; automatic transmission of the signal to another controller up to a maximum distance of 30 m.. Can be combined with Remote Control DRV8005 (optional). One Controller accepts up to 10 remote controls. Overheating / overload / short circuit protection, automatic reset. Can be inserted in standard wall junction box.

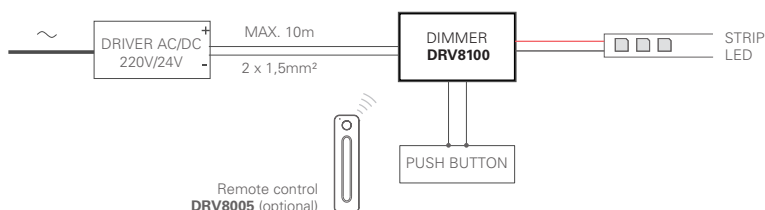

Remote Controller



misure L - H - P
size L - H - P

139 x 36 x 11 mm

Telecomando soft touch 1 canale a radiofrequenza opzionale per controlli luminosità DRV8100 - DRV8105. Fissaggio magnetico su apposita staffa a parete (inclusa). Regolazione dell'intensità ultra sensibile. Alimentato a batteria. (non inclusa)

Soft touch RF remote control for dimmer cod. DRV8105 and DRV8100. Magnetic fixing on suitable wall bracket (included). Ultra-sensitive dimming adjustment. Battery powered (not included).

descrizione <i>description</i>	codice <i>code</i>
Massima distanza 30 m. in area aperta / 30 m. max distance at open area	DRV8005

Controller per led monocromatici ogni controller può gestire uno o più ricevitori batteria CR2032. Magnete sul retro che può essere facilmente fissato ad ogni superficie metallica

Soft touch RF remote control for dimmer cod. DRV8105 and DRV8100. Magnetic fixing on suitable wall bracket (included). Ultra-sensitive dimming adjustment. Battery powered (not included).

misure L - H - P
size L - H - P

Ø 43 x 17 mm



Massima distanza 30 m. in area aperta / 30 m. max distance at open area	White	DRV8011
	Black	DRV8012



Monochrome control system

Dimmer Kit



controllo control	Remote control
tensione in ingr. voltage range	24V DC
codice code	DRV8201
potenza power	120 W
corrente in uscita output current	5A
tensione in uscita output voltage	24V DC
cl. isolamento / IP insulation class / IP	class III
misure L - H - P size L - H - P	45 x 13 x 5 mm

Kit per la regolazione dell'intensità luminosa delle Striped 24 V DC , (1 canale) . Si compone di telecomando a radiofrequenza e di ricevitore di segnale. L'utente può impostare la luminosità e gli effetti dinamici direttamente dal telecomando. Consente la regolazione dell'intensità luminosa su 10 livelli con 4 valori preimpostati. Fino a 8 effetti di dimming preimpostati. Massima distanza di funzionamento del telecomando fino a 15 m. in aria libera.

Dimmer Kit for managing 24 V DC Striped luminous intensity. Complete with RF control and remote dimmer for signal reception. The user can set Striped brightness and dynamic effects directly from the remote control. It achieves adjustment of luminous intensity on 10 levels with 4 preset values. Up to 8 preset dynamic effects. Maximum operating distance of the remote control up to 15 m. in open air.

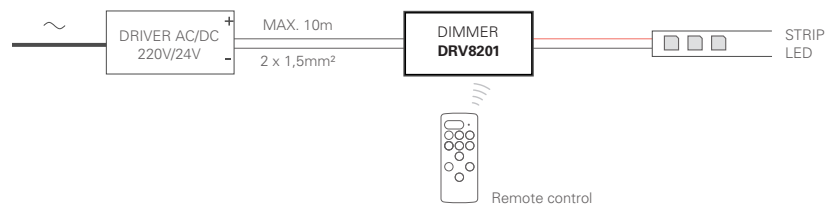

Dimmer Mesh



controllo control	Smartphone Bluetooth
tensione in ingr. voltage range	24V DC
codice code	DRV8210
potenza power	360 W
corrente in uscita output current	1x15A
tensione in uscita output voltage	24V DC
cl. isolamento / IP insulation class / IP	class III / IP63
misure L - H - P size L - H - P	86 x 21 x 8,5 mm

Dimmer con funzione "mesh" per la gestione dell'intensità luminosa delle Striped 24 V DC. Si possono realizzare reti sincronizzando fra loro più dimmer (fino a 4 gruppi di controllo, gestibili separatamente). Si attiva con applicazione Smartphone "Light Mesh" (disponibile su Apple, Android e Google Play). L'utente può impostare la luminosità delle Striped e gli effetti dinamici direttamente dall'applicazione. Scala dimmerazione 0-100%.

Mesh Dimmer for managing 24 V DC Striped luminous intensity. Mesh networks can be created by synchronizing multiple dimmers. Devices can be grouped (up to 4 control groups) and/or operated independently . "Light Mesh" APP managed by smartphone (Apple, Android and Google Play). The user can set Striped brightness and dynamic effects directly from the APP. Allows 0-100% luminous intensity adjustment.

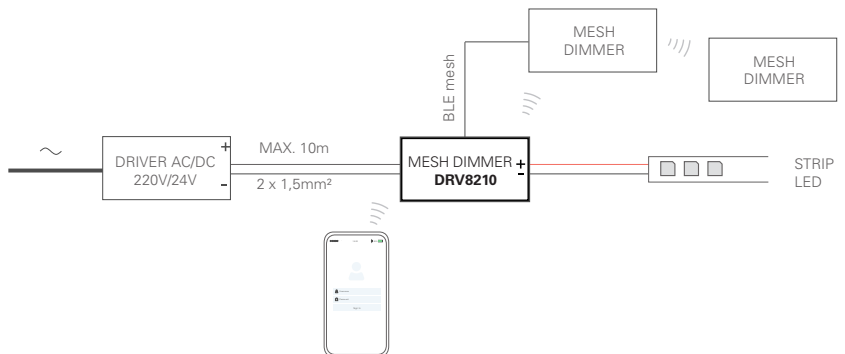

Dimmer DIN



controllo control	BUS DALI / Push N.O. / 0...10V - 1...10V Analogical / 1...10V Potentiometer
tensione in ingr. voltage range	24V DC
codice code	DRV9052
potenza power	max 156 W
corrente in uscita output current	max 1x 8 A
tensione in uscita output voltage	24V DC
cl. isolamento / IP insulation class / IP	class III / IP10
misure L - H - P size L - H - P	92 x 36 x 62 mm

Dimmer 1 canale per barra Din professionale; permette di pilotare StripLED monocromatiche in tensione costante mediante un comando a bus DALI o tramite un comando locale: comando a pulsante (Normalmente Aperto), segnale analogico 0÷10V o 1÷10V e potenziometro. Grazie alla funzione soft dimming garantisce un'accensione e uno spegnimento graduale. Dotato di effetto memoria in mancanza di tensione.

A professional single-channel Din rail device for regulating low voltage monochromatic LED strips through DALI protocols, or by local commands: N.O. push button, 0÷10V, 1÷10V or potentiometer. The soft dimming function ensures soft switching on and off. It also has a memory function power failure. This device has been designed for professional applications.

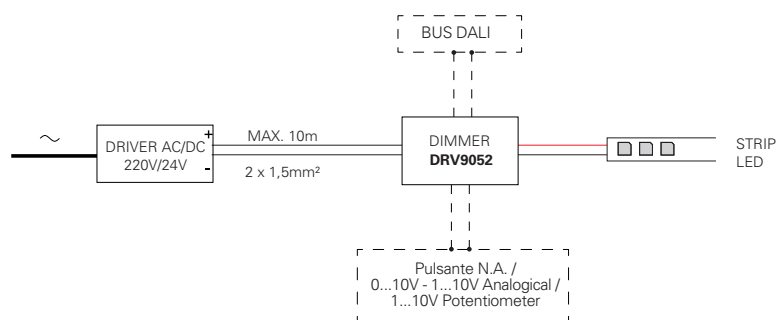



Tunable control system

Touch Panels



controllo <i>control</i>	DMX512, RF 2.4GHz / RF remote control
tensione in ingr. <i>voltage range</i>	85-265V AC
codice <i>code</i>	DRV8002
potenza <i>power</i>	\
corrente in uscita <i>output current</i>	\
tensione in uscita <i>output voltage</i>	\
cl. isolamento / IP <i>insulation class / IP</i>	class II / IP20
misure L - H - P <i>size L - H - P</i>	120 x 80 x 37 mm

Touch Panel capacitivo da parete, frontale in vetro ad alta resistenza. Ultra sensibile con ruota cromatica retroilluminata. Gestisce ON/OFF e regolazione luminosità 2 canali. Selezionabili 4 zone e 10 livelli di luminosità con 10 livelli di temperatura colore. Uscita segnale DMX conforme al protocollo DMX512 standard, è utilizzabile anche con telecomando remoto DRV8009 (non incluso). L'apparecchio si integra con il decoder DRV8122. Può pilotare fino a 20 decoder. Installabile in scatola parete 503 standard.

Ultra-sensitive capacitive high-resistance glass touch panel, wall application. Backlit color wheel set ON/OFF function and lumen flux 2 channels. 4 separate zones available, can be used also with remote control cod. DRV8009 (not included). Selection of 10 brightness levels ; 10 light color temperature levels. DMX signal output compliant with standard DMX512 protocol, compatible with decoder cod. DRV8122. Master up to 20 decoder. Can be installed in a standard 503 wall box.



(*) Scatola a muro 503 standard non inclusa.
(*) Standard 503 wall box not included.

Decoder



controllo <i>control</i>	DMX512
tensione in ingr. <i>voltage range</i>	24V DC
codice <i>code</i>	DRV8122
potenza <i>power</i>	4x 120 W
corrente in uscita <i>output current</i>	4CH, 5A/CH
tensione in uscita <i>output voltage</i>	4 x 24V DC
cl. isolamento / IP <i>insulation class / IP</i>	class II / IP20
misure L - H - P <i>size L - H - P</i>	170 x 50 x 23 mm

Decoder per segnale DMX512. Si integra con DRV8002 . Display numerico digitale con pulsanti di settaggio. Gestisce 1,2,3,4 canali. Funzionalità stand-alone. Selezionabile frequenza PWM 2000 / 500Hz e scala dimmer logaritmica o lineare. Max 20 decoder in cascata. Protezione da surriscaldamento / cortocircuito, ripristino automatico.

Decoder for DMX512 signal. Digital numerical display with touch switches setup. Stand-alone RGB / RGBW mode and selectable 4-channel dimmer mode. Accept codes DRV8002. Selectable 2000 / 500Hz PWM frequency. Linear or logarithmic dimmer curve selectable. Max 20 cascable decoder. Overheat / short circuit protection, automatic reset.

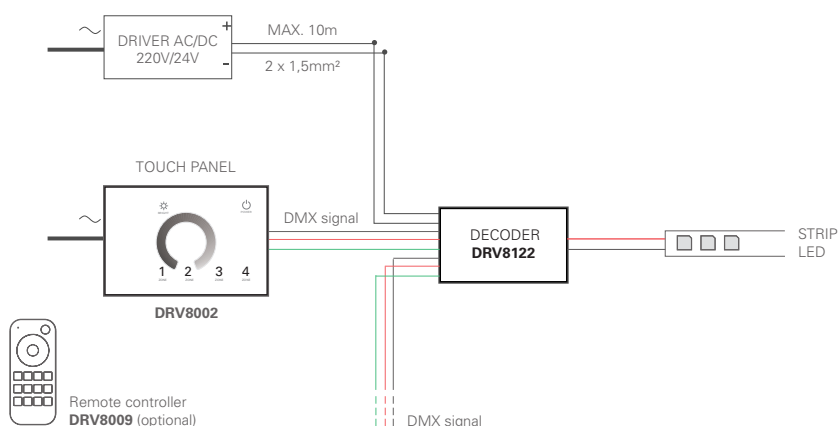

Remote Controller



misure L - H - P <i>size L - H - P</i>	122 x 53 x 17,5 mm
---	--------------------

Telecomando soft touch 2 canali a radiofrequenza opzionale per Touch Panel DRV8002. I singoli canali si attivano con leggera pressione sulla scala cromatica posta centralmente. 4 pulsanti dedicati per la selezione dell'intensità e del colore (bianco caldo / bianco freddo). 4 pulsanti dedicati per la selezione delle zone. Fissaggio magnetico su apposita staffa a parete (inclusa). Alimentato da batteria. (non inclusa).

Optional radio frequency soft touch remote control for DRV8002 Touch Panel. Ultra sensitive with a touch color wheel in the center. 4 buttons for brightness and colour selection (warm white / cool white). 4 buttons for zone selection. Magnetic fixing on special wall bracket (included). Battery powered (not included).

descrizione <i>description</i>	codice <i>code</i>
Massima distanza 30 m. in area aperta / 30 m. max distance at open area	DRV8009

Tunable control system

Controller



controllo <i>control</i>	RF remote control / Push Dim.
tensione in ingr. <i>voltage range</i>	24V DC
codice <i>code</i>	DRV8110
potenza <i>power</i>	192W
corrente in uscita <i>output current</i>	2CH, 8A/CH
tensione in uscita <i>output voltage</i>	24V DC
cl. isolamento / IP <i>insulation class / IP</i>	class II / IP20
misure L - H - P <i>size L - H - P</i>	175 x 45 x 27 mm

Dimmer control 2 canali con funzione "push" - ricevitore a radiofrequenza. Nella funzione "push" il pulsante esterno comanda accensione e regolazione luminosa. Scala dimmerazione 0-100%, uniforme e progressiva. Max 20 dimmer sincronizzabili. Funzione di trasmissione automatica; trasmette automaticamente il segnale a un altro controller fino a una distanza massima di 30 m. Abbinabile a Telecomando DRV8006 (opzionale). Un Controller accetta fino a 10 telecomandi. Protezione da surriscaldamento / sovraccarico / cortocircuito, ripristino automatico.

RF dimmer control with "push" function. Chromatic adjustment and 0-100% dimming, without stroboscopic effect. Overheating / overload / short circuit protection, automatic reset. Synchronization on multiple Dimmer (max 20). Automatic transmission function; automatically transmits the signal to another controller up to a maximum distance of 30 m. Connect with an external switch to achieve switching on / off , colour regulation and 0-100% dimming function. Can be combined with Remote Control DRV8006 (optional). One Controller accepts up to 10 remote controls.

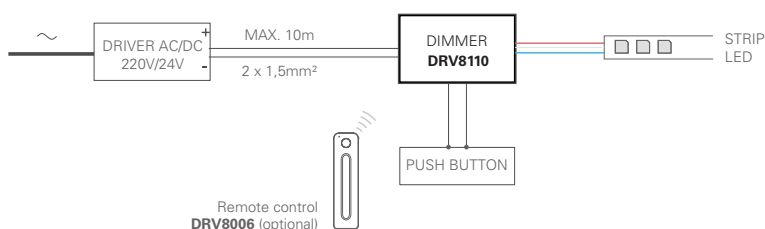

Remote Controller



Telecomando soft touch 2 canali a radiofrequenza opzionale per Dimmer Control DRV8110. Fissaggio magnetico su apposita staffa a parete (inclusa). Regolazione dell'intensità dei singoli canali ultra sensibile. Alimentato a batteria. (non inclusa)

Optional radio frequency soft touch remote control for Dimmer Control cod. DRV8110. Magnetic fixing on special wall bracket (included). Regulation of intensity and ultra-sensitive chromaticity. Battery powered (not included).

misure L - H - P <i>size L - H - P</i>	139 x 36 x 11 mm
---	------------------

descrizione
description

Massima distanza 30 m. in area aperta / 30 m. max distance at open area

codice
code

DRV8006



Tunable control system

Tunable Dimmer Kit



Kit per la regolazione dell'intensità luminosa delle Stripled 24 V DC , (2 canali) . Si compone di telecomando a radiofrequenza e di ricevitore di segnale. L'utente può impostare la luminosità e la temperatura di colore desiderata insieme agli effetti dinamici direttamente dal telecomando. Consente la regolazione dell'intensità luminosa su 11 livelli con 6 valori preimpostati. Fino a 8 effetti di dimming preimpostati. Massima distanza di funzionamento del telecomando fino a 15 m. in aria libera.

Tunable white Dimmer Kit for managing 24 V DC Stripled luminous intensity and color temperature. Complete with wireless RF control and remote dimmer for signal reception. The user can set the brightness and color temperature of the Stripled and dynamic effects directly from the remote control. It achieves adjustment of luminous intensity on 11 levels with 6 preset values. Maximum operating distance from the remote control up to 15 m. in free air.

controllo control	Remote control
tensione in ingr. voltage range	24V DC
codice code	DRV8203
potenza power	144 W
corrente in uscita output current	2x 3A
tensione in uscita output voltage	24V DC
cl. isolamento / IP insulation class / IP	class III
misure L - H - P size L - H - P	45 x 13 x 5 mm

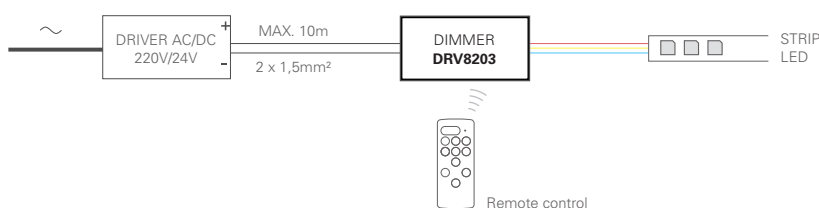

Tunable Dimmer Mesh



Dimmer 2 canali con funzione "mesh" per la gestione dell'intensità luminosa e della temperatura colore delle Stripled 24 V DC. Si possono realizzare reti sincronizzando fra loro più dimmer (fino a 4 gruppi di controllo, gestibili separatamente). Si attiva con applicazione Smartphone "Light Mesh" (disponibile su Apple, Android e Google Play). L'utente può impostare la luminosità, la temperatura colore insieme ad effetti dinamici direttamente dall'applicazione. Scala dimmerazione 0-100%.

Mesh Dimmer for managing 24 V DC Stripled luminous intensity and color temperature. Mesh networks can be created by synchronizing multiple dimmers . Devices can be grouped (up to 4 control groups) and/or operated independently . "Light Mesh" APP managed by smartphone (Apple, Android and Google Play). The user can set the brightness and the color temperature of the Stripled and the dynamic effects directly from the application. Allows 0-100% luminous intensity and color temperature adjustment.

controllo control	Smartphone Bluetooth
tensione in ingr. voltage range	24V DC
codice code	DRV8212
potenza power	336 W
corrente in uscita output current	2x7A
tensione in uscita output voltage	24V DC
cl. isolamento / IP insulation class / IP	class III / IP63
misure L - H - P size L - H - P	86 x 21 x 8,5 mm

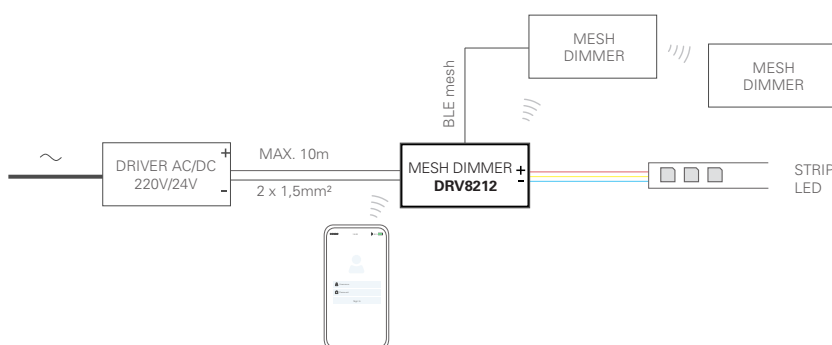

RGB+W control system



Touch Panels



controllo control	DMX512, RF 2.4GHz / RF remote control
tensione in ingr. voltage range	85-265V AC
codice code	DRV8003
potenza power	\
corrente in uscita output current	\
tensione in uscita output voltage	\
cl. isolamento / IP insulation class / IP	class II / IP20
misure L - H - P size L - H - P	120 x 80 x 37 mm

Touch Panel capacitivo da parete, frontale in vetro ad alta resistenza. Ultra sensibile con ruota cromatica retroilluminata. Gestisce ON/OFF e regolazione luminosità 4 canali, selezionabili 4 zone e 10 livelli di luminosità con 10 livelli di cromaticità della luce. Uscita segnale DMX conforme al protocollo DMX512 standard, è utilizzabile anche con telecomando remoto DRV8010 (non incluso). L'apparecchio si integra con il decoder DRV8122. Può pilotare fino a 20 decoder. Installabile in scatola parete 503 standard.

Ultra-sensitive capacitive high-resistance glass touch panel, wall application. Backlit color wheel set ON/OFF function and single color channel. 4 separate zones available, 10 different brightness levels and 10 chromatic levels. Automatic cyclic color function. DMX signal output compliant with standard DMX512 protocol, compatible with remote control DRV8010 (not included) and decoder cod. DRV8122. Master up to 20 decoders. Can be installed in a standard 503 wall box.



(*) Scatola a muro 503 standard non inclusa.

(*) Standard 503 wall box not included.

Decoder



controllo control	DMX512
tensione in ingr. voltage range	24V DC
codice code	DRV8122
potenza power	4x 120 W
corrente in uscita output current	4CH, 5A/CH
tensione in uscita output voltage	4 x 24V DC
cl. isolamento / IP insulation class / IP	class II / IP20
misure L - H - P size L - H - P	170 x 50 x 23 mm

Decoder per segnale DMX512. Si integra con DRV8003. Display numerico digitale con pulsanti di settaggio. Gestisce 1,2,3,4 canali. Funzionalità stand-alone. Selezionabile frequenza PWM 2000 / 500Hz e scala dimmer logaritmica o lineare. Max 20 decoder in cascata. Protezione da surriscaldamento / cortocircuito, ripristino automatico.

Decoder for DMX512 signal. Digital numerical display with touch switches setup. Stand-alone RGB / RGBW mode and selectable 4-channel dimmer mode. Accept codes DRV8003. Selectable 2000 / 500Hz PWM frequency. Linear or logarithmic dimmer curve selectable. Max 20 cascadable decoder. Overheat / short circuit protection, automatic reset.

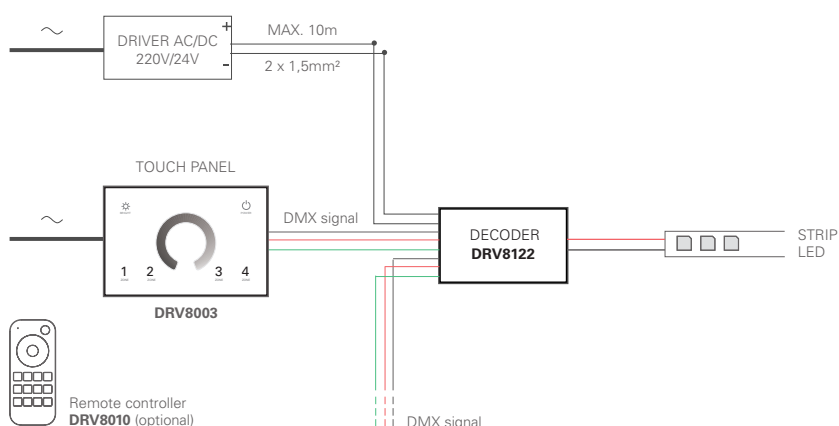

Remote Controller



misure L - H - P size L - H - P	122 x 53 x 17,5 mm
------------------------------------	--------------------

Telecomando soft touch 4 canali a radiofrequenza opzionale per Touch Panel DRV8003. I singoli canali si attivano con leggera pressione sulla scala cromatica posta centralmente. Selezione di 10 livelli di luminosità e 10 livelli di cromaticità della luce in modalità RGBW. Funzione colore in ciclo automatico. Selezione colori statici RGBW. Fissaggio magnetico su apposita staffa a parete (inclusa). Alimentato a batteria. (non inclusa).

Optional radio frequency soft touch remote control for DRV8003 Touch Panel. Ultra sensitive with a touch color wheel in the center. Selection of 10 brightness levels and 10 colour levels in RGBW mode. Automatic cyclic colour function. RGBW static colour selection. Magnetic fixing on special wall bracket (included). Battery powered (not included).

descrizione
description

Massima distanza 30 m. in area aperta / 30 m. max distance at open area

codice
code

DRV8010

RGB+W control system



Controller



controllo <i>control</i>	RF remote control / Push Dim.
tensione in ingr. <i>voltage range</i>	24V DC
codice <i>code</i>	DRV8120
potenza <i>power</i>	4 x 180 W
corrente in uscita <i>output current</i>	4CH, 5A/CH
tensione in uscita <i>output voltage</i>	24V DC
cl. isolamento / IP <i>insulation class / IP</i>	class II / IP20
misure L - H - P <i>size L - H - P</i>	175 x 45 x 27 mm

Dimmer control 4 canali e ricevitore a radiofrequenza. Scala dimmerazione singoli canali 0-100%, uniforme e progressiva. Max 20 dimmer sincronizzabili. Funzione di trasmissione automatica; trasmette automaticamente il segnale a un altro controller fino a una distanza massima di 30 m. Abbinabile a Telecomando DRV8007 (opzionale). Il componente accetta fino a 10 telecomandi. Protezione da surriscaldamento / sovraccarico / cortocircuito, ripristino automatico. Presente anche la funzione "push" attivabile con 4 pulsanti esterni che comandano accensione e regolazione singoli canali.

4 channels controller with "push" function. Chromatic adjustment and 0-100% dimming, without stroboscopic effect Overheating / overload / short circuit protection, automatic reset. Synchronization on multiple Dimmer (max 20). Automatic transmission function; automatically transmits the signal to another controller up to a maximum distance of 30 m. Connect with 4 external buttons to achieve switching on / off, colour adjustment, 0-100% dimming function. Can be combined with Remote Control DRV8007 (optional). One Controller accepts up to 10 remote controls.

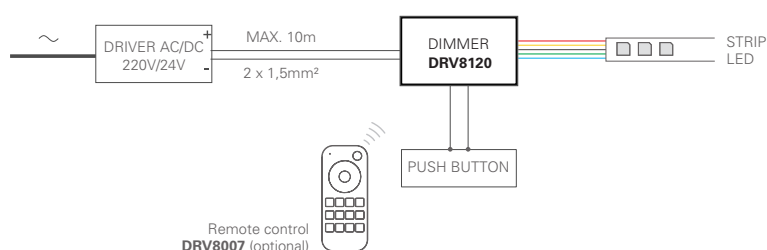

Remote Controller



misure L - H - P <i>size L - H - P</i>	122 x 53 x 17 mm
---	------------------

Telecomando soft touch 4 canali a radiofrequenza opzionale per Dimmer Control DRV8120. I singoli canali si attivano con leggera pressione sulla scala cromatica posta centralmente. Selezione di 10 livelli di luminosità e 10 livelli di cromaticità della luce in modalità RGBW. Funzione colore in ciclo automatico. Selezione colori statici RGBW. Fissaggio magnetico su apposita staffa a parete (inclusa). Alimentato a batteria. (non inclusa)

Optional radio frequency soft touch remote control for Dimmer Control cod. DRV8120. Ultra sensitive with a touch color wheel in the center. Selection of 10 brightness levels and 10 colour levels in RGBW mode. Automatic cyclic color function. RGBW static color selection. Magnetic fixing on special wall bracket (included). Battery powered.

descrizione
description

Massima distanza 30 m. in area aperta / 30 m. max distance at open area

codice
code

DRV8007



RGB+W control system

RGB+W Dimmer Kit

Kit per la regolazione dell'intensità luminosa e della cromaticità delle Striped 24 V DC , (4 canali - RGBW) . Si compone di telecomando a radiofrequenza e di ricevitore di segnale. L'utente può impostare la luminosità, il colore dei singoli canali e gli effetti dinamici direttamente dal telecomando. Massima distanza di funzionamento del telecomando fino a 15 m. in aria libera.

RGBW Dimmer Kit for managing 24 V DC Striped luminous intensity and colour. Complete with wireless RF control and remote dimmer for signal reception. The user can set the brightness, colour and dynamic effects of the Striped directly from the remote control. It achieves adjustment of static and dynamic colours and luminous intensity as well. Maximum operating distance from the remote control up to 15 m. in free air.



controllo control	Remote control
tensione in ingr. voltage range	24V DC
codice code	DRV8025
potenza power	192 W
corrente in uscita output current	4x2A
tensione in uscita output voltage	24V DC
cl. isolamento / IP insulation class / IP	class III
misure L - H - P size L - H - P	45 x 13 x 5 mm

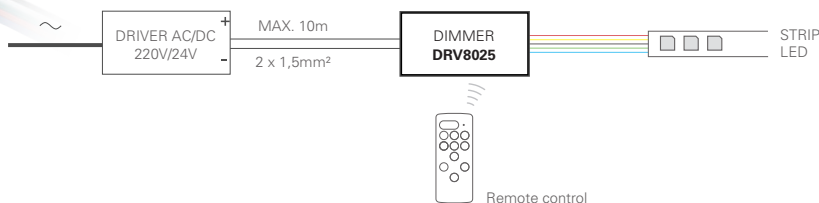

Specifiche telecomando / Specification remote control

Colori statici / Static color	30 colori / 30 colors
Effetti dinamici / Dynamic effect	42 modi / 42 modes
Grado di luminosità bianco / White brightness grade	10 livelli / 10 levels
Grado di luminosità del colore / Color brightness grade	5 livelli / 5 levels
Velocità / Speed	10 livelli / 10 levels
Selezione diretta del colore / Direct color select	7 tasti diretti / 7 direct keys

RGB+W Dimmer Mesh

Dimmer 4 canali con funzione "mesh" per la gestione dell'intensità luminosa e dei singoli colori su Striped 24 V DC RGBW. Si possono realizzare reti sincronizzando fra loro più dimmer (fino a 4 gruppi di controllo, gestibili separatamente). Si attiva con applicazione Smartphone "Light Mesh" (disponibile su Apple, Android e Google Play). L'utente può impostare la luminosità, la temperatura colore insieme ad effetti dinamici direttamente dall'applicazione. Scala dimmerazione 0-100%.

Mesh Dimmer for managing 24 V DC Striped luminous intensity and color temperature. Mesh networks can be created by synchronizing multiple dimmers . Devices can be grouped (up to 4 control groups) and/or operated independently . "Light Mesh" APP managed by smartphone (Apple, Android and Google Play). The user can set the brightness and the color temperature of the Striped and the dynamic effects directly from the application. Allows 0-100% luminous intensity and color temperature adjustment.



controllo control	Smartphone Bluetooth
tensione in ingr. voltage range	24V DC
codice code	DRV8215
potenza power	\
corrente in uscita output current	3x3A + 5A
tensione in uscita output voltage	24V DC
cl. isolamento / IP insulation class / IP	class III / IP63
misure L - H - P size L - H - P	86 x 21 x 8,5 mm

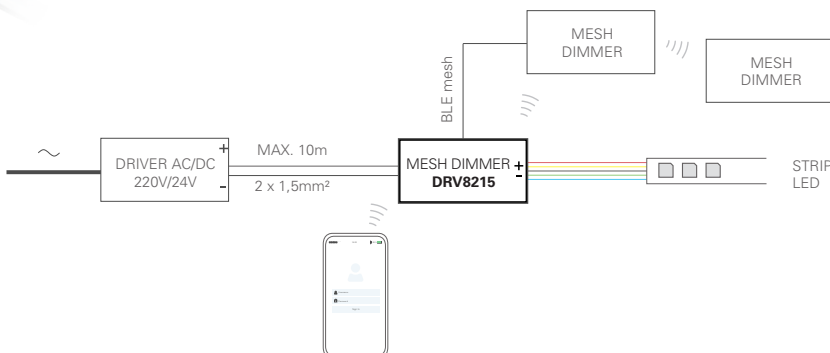

RGB+W control system



Dimmer



Dispositivo multicanale di controllo per la gestione colore RGBW. La funzione soft dimming garantisce un'accensione e spegnimento morbido. Dotato di 2 ingressi a pulsante normalmente aperto per comando locale.

Multi-channel control device for RGBW colour adjustment. Soft dimming. Complete with 2 N.O. buttons for local control.

controllo <i>control</i>	2x N.O. Push Buttons
tensione in ingr. <i>voltage range</i>	24V DC
codice <i>code</i>	DRV9008
potenza <i>power</i>	max 240 W
corrente in uscita <i>output current</i>	4x 5A (max 10A tot.)
tensione in uscita <i>output voltage</i>	12 / 24V DC
cl. isolamento / IP <i>insulation class / IP</i>	class III / IP20
misure L - H - P <i>size L - H - P</i>	88 x 54 x 26 mm

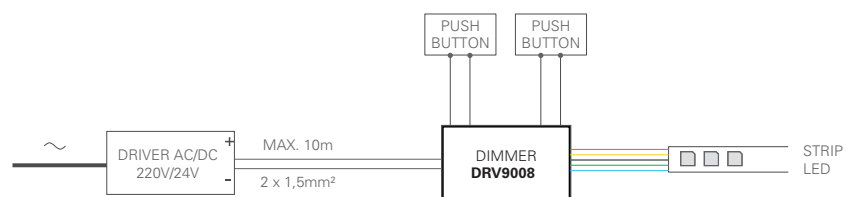

Booster



Il Booster è un amplificatore di segnale PWM da utilizzare con centralina DRV9008.

The Booster is a PWM signal amplifier to be used with DRV9008 control unit.

controllo <i>control</i>	D-PWM
tensione in ingr. <i>voltage range</i>	24V DC
codice <i>code</i>	DRV9009
potenza <i>power</i>	max 240 W
corrente in uscita <i>output current</i>	4x 5A (max 10A tot.)
tensione in uscita <i>output voltage</i>	12 / 24V DC
cl. isolamento / IP <i>insulation class / IP</i>	class III / IP20
misure L - H - P <i>size L - H - P</i>	89 x 54 x 26 mm

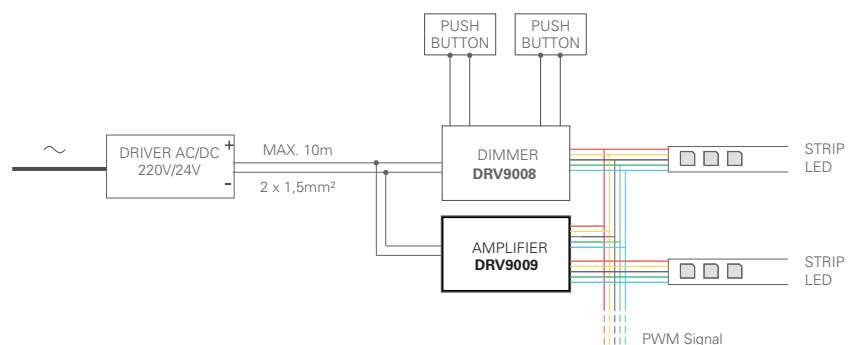

Control systems



Dimmer DIN



controllo <i>control</i>	BUS DALI / Push N.O. / 0...10V - 1...10V Analogical / 1...10V Potentiometer
tensione in ingr. <i>voltage range</i>	24V DC
codice <i>code</i>	DRV9053
potenza <i>power</i>	max 480 W
corrente in uscita <i>output current</i>	max 4x 5 A / max 1x 20 A
tensione in uscita <i>output voltage</i>	24V DC
cl. isolamento / IP <i>insulation class / IP</i>	class III / IP10
misure L - H - P <i>size L - H - P</i>	72 x 92 x 62 mm

Dispositivo per barra Din professionale 4 canali; controlla separatamente le 4 uscite e permette di effettuare la più ampia regolazione della luminosità. Accetta segnali comando BUS – DALI o comando locale: a pulsante (Normalmente Aperto), segnale analogico 0÷10V o 1÷10V e potenziometro. Grazie alla funzione “soft dimming” garantisce un’accensione ed uno spegnimento graduale. Dotato di effetto memoria in mancanza di tensione. Ingresso analogico richiede 1 pulsante per ogni canale. Il componente non svolge funzioni “slave”. E’ indicato per la gestione di strip monocromatiche, bianco variabile, RGBW.

A professional Din rail device. Multi-channel LED control unit, can be used to regulate LED Strips white through BUS-DALI protocols. The soft dimming function ensures soft switching on and off. It also has a memory function power failure. Input selection: 4 N.O. push buttons, 0÷10V, 1÷10V or potentiometer. Analogic input need 1 button each channel. Cannot be used as “slave”. Operate with striped single color, tunable white and RGBW.

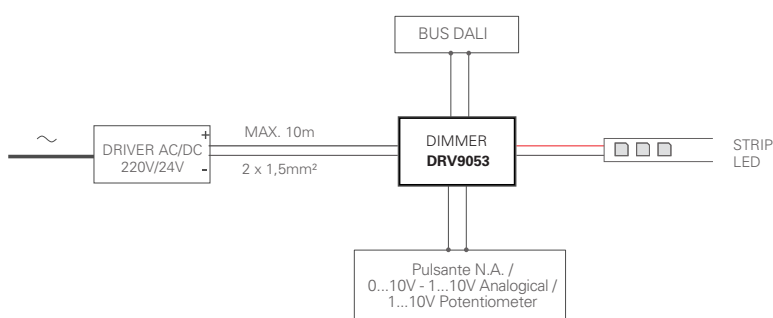

controllo <i>control</i>	BUS DMX / Push N.O. / 0...10V - 1...10V Analogical / 1...10V Potentiometer
tensione in ingr. <i>voltage range</i>	24V DC
codice <i>code</i>	DRV9054
potenza <i>power</i>	max 480 W
corrente in uscita <i>output current</i>	max 4x 5 A / max 1x 20 A
tensione in uscita <i>output voltage</i>	24V DC
cl. isolamento / IP <i>insulation class / IP</i>	class III / IP10
misure L - H - P <i>size L - H - P</i>	72 x 92 x 62 mm

Dispositivo per barra Din professionale 4 canali; controlla separatamente le 4 uscite e permette di effettuare la più ampia regolazione della luminosità. Accetta segnali comando BUS – DMX o comando locale: a pulsante (Normalmente Aperto), segnale analogico 0÷10V o 1÷10V e potenziometro. Grazie alla funzione “soft dimming” garantisce un’accensione ed uno spegnimento graduale. Dotato di effetto memoria in mancanza di tensione. Ingresso analogico richiede 1 pulsante per ogni canale. Il componente può funzionare in modalità “master – slave”. E’ indicato per la gestione di strip monocromatiche, bianco variabile, RGBW anche in impianti complessi.

A professional Din rail device. Multi-channel LED control unit, can be used to regulate LED Strips white through BUS-DMX protocols. The soft dimming function ensures soft switching on and off. It also has a memory function power failure. Input selection: 4 N.O. push buttons, 0÷10V, 1÷10V or potentiometer. Analogic input need 1 button each channel. The control unit 4 channels also works in master/slave mode. Operate with striped single color, tunable white and RGBW.

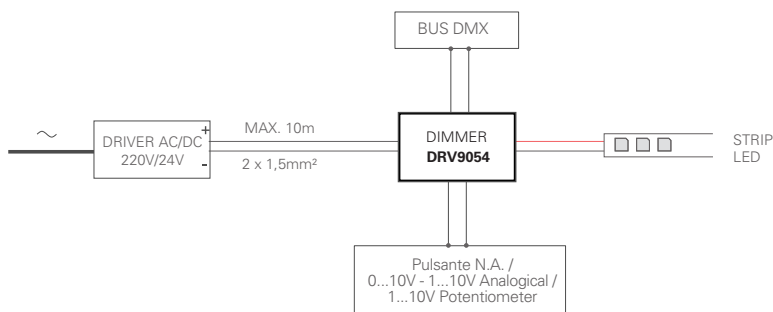

Drivers

Tensione Costante IP20 / Costant Voltage IP20

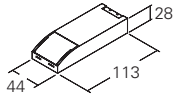

controllo control	on-off
tensione in uscita output voltage	12V DC
codice code	DRV2000
corrente in uscita output current	0 ÷ 1,7 A
potenza power	max 20 W
tensione in ingr. voltage range	220÷240 V - 50 / 60 Hz
cl. isolamento / IP insulation class / IP	class II / IP20
peso weight	0,09 kg

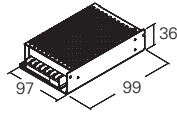

controllo control	on-off
tensione in uscita output voltage	12V DC
codice code	DRV2004
corrente in uscita output current	0 ÷ 4,2 A
potenza power	max 50 W
tensione in ingr. voltage range	220÷240 V - 50 / 60 Hz
cl. isolamento / IP insulation class / IP	class I / IP\
peso weight	0,25 kg

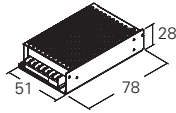

controllo control	on-off
tensione in uscita output voltage	24V DC
codice code	DRV2005
corrente in uscita output current	0 ÷ 2,2 A
potenza power	max 50 W
tensione in ingr. voltage range	220÷240 V - 50 / 60 Hz
cl. isolamento / IP insulation class / IP	class I / IP\
peso weight	0,25 kg

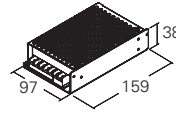

controllo control	on-off
tensione in uscita output voltage	24V DC
codice code	DRV2007
corrente in uscita output current	0 ÷ 4,5 A
potenza power	max 100 W
tensione in ingr. voltage range	220÷240 V - 50 / 60 Hz
cl. isolamento / IP insulation class / IP	class I / IP\
peso weight	0,56 kg

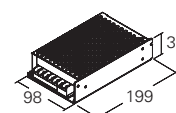

controllo control	on-off
tensione in uscita output voltage	24V DC
codice code	DRV2009
corrente in uscita output current	0 ÷ 6,5 A
potenza power	max 150 W
tensione in ingr. voltage range	220÷240 V - 50 / 60 Hz
cl. isolamento / IP insulation class / IP	class I / IP\
peso weight	0,64 kg

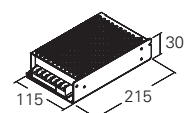

controllo control	on-off
tensione in uscita output voltage	24V DC
codice code	DRV2011
corrente in uscita output current	0 ÷ 8,4 A
potenza power	max 200 W
tensione in ingr. voltage range	220÷240 V - 50 / 60 Hz
cl. isolamento / IP insulation class / IP	class I / IP\
peso weight	0,81 kg

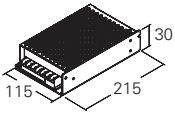

controllo control	on-off
tensione in uscita output voltage	24V DC
codice code	DRV2012 (*)
corrente in uscita output current	0 ÷ 13,4 A
potenza power	max 320 W
tensione in ingr. voltage range	220÷240 V - 50 / 60 Hz
cl. isolamento / IP insulation class / IP	class I / IP\
peso weight	0,90 kg

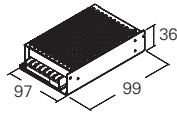

controllo control	on-off
tensione in uscita output voltage	48V DC
codice code	51097
corrente in uscita output current	0 ÷ 11 A
potenza power	max 50 W
tensione in ingr. voltage range	220÷240 V - 50 / 60 Hz
cl. isolamento / IP insulation class / IP	class I / IP\
peso weight	0,25 kg

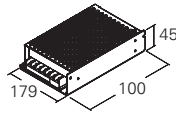

controllo control	on-off
tensione in uscita output voltage	48V DC
codice code	51066
corrente in uscita output current	0 ÷ 2,1 A
potenza power	max 100 W
tensione in ingr. voltage range	220÷240 V - 50 / 60 Hz
cl. isolamento / IP insulation class / IP	class I / IP\
peso weight	0,56 kg

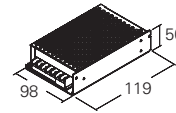

controllo control	on-off
tensione in uscita output voltage	48V DC
codice code	51074
corrente in uscita output current	0 ÷ 4,2 A
potenza power	max 200 W
tensione in ingr. voltage range	220÷240 V - 50 / 60 Hz
cl. isolamento / IP insulation class / IP	class I / IP\
peso weight	0,89 kg

(*) Raffreddamento ad aria forzata tramite ventilatore incorporato. / Forced air cooling by built-in fan.

Tensione Costante IP67 / Costant Voltage IP67

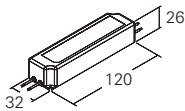

controllo control	on-off
tensione in uscita output voltage	24V DC
codice code	DRV2051
corrente in uscita output current	0 ÷ 0,75 A
potenza power	max 18 W
tensione in ingr. voltage range	220÷240 V - 50 / 60 Hz
cl. isolamento / IP insulation class / IP	class II / IP67
peso weight	0,17 kg

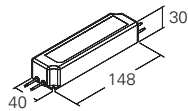

controllo control	on-off
tensione in uscita output voltage	24V DC
codice code	DRV2053
corrente in uscita output current	0 ÷ 1,5 A
potenza power	max 35 W
tensione in ingr. voltage range	220÷240 V - 50 / 60 Hz
cl. isolamento / IP insulation class / IP	class II / IP67
peso weight	0,34 kg

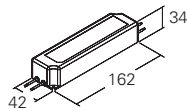

controllo control	on-off
tensione in uscita output voltage	24V DC
codice code	DRV2057
corrente in uscita output current	0 ÷ 2,5 A
potenza power	max 60 W
tensione in ingr. voltage range	220÷240 V - 50 / 60 Hz
cl. isolamento / IP insulation class / IP	class II / IP67
peso weight	0,40 kg

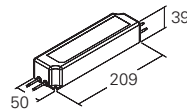

controllo control	on-off
tensione in uscita output voltage	24V DC
codice code	DRV2061
corrente in uscita output current	0 ÷ 4,2 A
potenza power	max 100 W
tensione in ingr. voltage range	220÷240 V - 50 / 60 Hz
cl. isolamento / IP insulation class / IP	class II / IP67
peso weight	0,63 kg

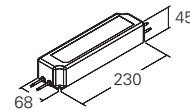

controllo control	on-off
tensione in uscita output voltage	24V DC
codice code	DRV2063
corrente in uscita output current	0 ÷ 6,3 A
potenza power	max 150 W
tensione in ingr. voltage range	220÷240 V - 50 / 60 Hz
cl. isolamento / IP insulation class / IP	class I / IP67
peso weight	1,00 kg

Drivers

Corrente Costante IP20 / *Costant Current IP20*

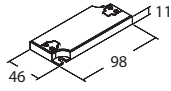

controllo <i>control</i>	on-off
corrente in uscita <i>output current</i>	350 mA
codice <i>code</i>	DRV1008
potenza <i>power</i>	max 6 W
tensione in uscita <i>output voltage</i>	2 ÷ 18V DC
tensione in ingr. <i>voltage range</i>	220÷240 V - 50 / 60 Hz
cl. isolamento / IP <i>insulation class / IP</i>	class II / IP20
peso <i>weight</i>	0,04 kg

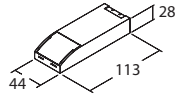

	Phase cut IGBT / TRIAC
corrente in uscita <i>output current</i>	350 mA
codice <i>code</i>	DRV1006
potenza <i>power</i>	max 18 W
tensione in uscita <i>output voltage</i>	15 ÷ 52V DC
tensione in ingr. <i>voltage range</i>	220÷240 V - 50 / 60 Hz
cl. isolamento / IP <i>insulation class / IP</i>	class II / IP20
peso <i>weight</i>	0,10 kg

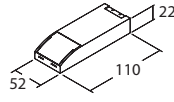

	Phase cut IGBT / TRIAC
corrente in uscita <i>output current</i>	700 mA
codice <i>code</i>	DRV1035
potenza <i>power</i>	max 20 W
tensione in uscita <i>output voltage</i>	5 ÷ 29V DC
tensione in ingr. <i>voltage range</i>	220÷240 V - 50 / 60 Hz
cl. isolamento / IP <i>insulation class / IP</i>	class II / IP20
peso <i>weight</i>	0,10 kg

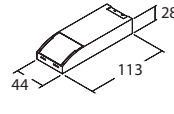

	on-off
corrente in uscita <i>output current</i>	700 mA
codice <i>code</i>	DRV1005
potenza <i>power</i>	max 20 W
tensione in uscita <i>output voltage</i>	2 ÷ 29V DC
tensione in ingr. <i>voltage range</i>	220÷240 V - 50 / 60 Hz
cl. isolamento / IP <i>insulation class / IP</i>	class II / IP20
peso <i>weight</i>	0,09 kg

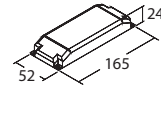

	Phase cut IGBT / TRIAC
corrente in uscita <i>output current</i>	700 mA
codice <i>code</i>	DRV1013
potenza <i>power</i>	max 36 W
tensione in uscita <i>output voltage</i>	24 ÷ 52V DC
tensione in ingr. <i>voltage range</i>	220÷240 V - 50 / 60 Hz
cl. isolamento / IP <i>insulation class / IP</i>	class II / IP20
peso <i>weight</i>	0,21 kg

Corrente Costante IP67 / *Costant Current IP67*

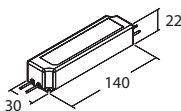

controllo <i>control</i>	on-off
corrente in uscita <i>output current</i>	350 mA
codice <i>code</i>	DRV1050
potenza <i>power</i>	max 16,8 W
tensione in uscita <i>output voltage</i>	6 ÷ 48V DC
tensione in ingr. <i>voltage range</i>	220÷240 V - 50 / 60 Hz
cl. isolamento / IP <i>insulation class / IP</i>	class II / IP67
peso <i>weight</i>	0,17 kg

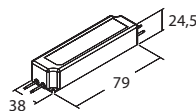

	on-off
corrente in uscita <i>output current</i>	350 mA
codice <i>code</i>	DRV1069
potenza <i>power</i>	max 14 W
tensione in uscita <i>output voltage</i>	3 ÷ 40V DC
tensione in ingr. <i>voltage range</i>	220÷240 V - 50 / 60 Hz
cl. isolamento / IP <i>insulation class / IP</i>	class II / IP67
peso <i>weight</i>	0,14 kg

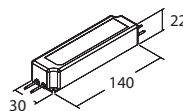

	on-off
corrente in uscita <i>output current</i>	700 mA
codice <i>code</i>	DRV1060
potenza <i>power</i>	max 17,5 W
tensione in uscita <i>output voltage</i>	6 ÷ 25V DC
tensione in ingr. <i>voltage range</i>	220÷240 V - 50 / 60 Hz
cl. isolamento / IP <i>insulation class / IP</i>	class II / IP67
peso <i>weight</i>	0,17 kg

Sincro Cables



Cavetto di sincronizzazione singolo canale per l'utilizzo con driver dimmerabili PUSH / 1...10 V e DALI.

3 lunghezze disponibili 0,50 cm, 1,50 m e 4,00 m

Compatibile con:

Egon 23 / 29 W, serie Backlit; serie Led Panel ; Moby 24 / 33 / 42 W , Nemo 24 / 33 / 42 W

Single channel synchronization cable to use with dimmable PUSH / 1...10 V / DALI drivers.

Available 3 lengths: 0,50 cm, 1,50 m e 4,00 m

Compatible with:

Egon 23 / 29 W, Backlit series; Led Panel series; Moby 24 / 33 / 42 W , Nemo 24 / 33 / 42 W

descrizione <i>description</i>	codice <i>code</i>
Lunghezza cavo 0,5 m. / <i>Lenght cable 0,5 m.</i>	DRV0010
Lunghezza cavo 1,5 m. / <i>Lenght cable 1,5 m.</i>	DRV0011
Lunghezza cavo 4 m. / <i>Lenght cable 4 m.</i>	DRV0012

Kit di emergenza / *Emergency Kit*

Per power LED e moduli LED / *For power LED and LED modules*

Funzionamento in sola emergenza o in luce continua in abbinamento con alimentatori elettronici, elettronici dimmerabili. Versione regolabile con dip-switch, per power LED a corrente costante o per moduli LED a tensione costante. Intervento istantaneo ad ogni mancanza di rete. Include indicatore di ricarica a LED.

Operates in emergency only and continuous light in combination with electronic power supply and dimmerable electronics. Adjustable version with dipswitch for constant current power LED or constant voltage LED modules. Instant response to any power failure. Includes LED charging indicator.

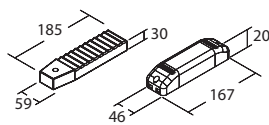

autonomia <i>operating time</i>	1 h
tempo di ricarica <i>change time</i>	24 h
codice <i>code</i>	DRV9092
corrente in uscita <i>output current</i>	350 ÷ 85 mA (emergency mode)
tensione in uscita <i>output voltage</i>	9 ÷ 58 DC (emergency mode)
tensione in ingr. <i>voltage range</i>	220÷240 V - 50 / 60 Hz
d. isolamento / IP <i>insulation class / IP</i>	class II / IP20
peso <i>weight</i>	0,43 kg

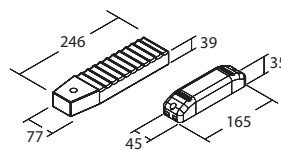

autonomia <i>operating time</i>	3 h
tempo di ricarica <i>change time</i>	24 h
codice <i>code</i>	DRV9091
corrente in uscita <i>output current</i>	350 ÷ 85 mA (emergency mode)
tensione in uscita <i>output voltage</i>	9 ÷ 58 DC (emergency mode)
tensione in ingr. <i>voltage range</i>	220÷240 V - 50 / 60 Hz
d. isolamento / IP <i>insulation class / IP</i>	class II / IP20
peso <i>weight</i>	0,88 kg

Conforme alle Norme / *Compliant with standards:*

EN 55015; EN 60598-2-22; EN 61000-3-2; EN 61347-2-13; EN 61347-2-7; EN 61547

Specifiche / *Specifications*

- Protetto in classe II contro le scosse elettriche per contatti diretti e indiretti
- Utilizzabile per apparecchi di illuminazione in classe di protezione I e II .
- Intervento istantaneo ad ogni mancanza di rete.
- Funzionamento in sola emergenza o in luce continua (luce continua in abbinamento con alimentatori elettronici e alimentatori elettronici dimmerabili).
- Regolazione con DIP-SWITCH, per power LED a corrente costante o per moduli LED a tensione costante.
- Batterie tipo Ni-Cd / Ni-MH "alta temperatura".
- Indicatore di ricarica a LED.
- Possibilità d'inibizione in "modo riposo" con telecomando esterno centralizzato.
- Class II protection against electric shock for direct or indirect contact
- It can be used for lighting equipment in protection class I and II
- Instant emergency operation at mains failure.
- Maintained or not maintained operation (maintained operation suitable with electronic drivers or dimmable electronic drivers).
- Multi-power dimmable version DIP-SWITCH, constant current or constant voltage to power LED to LED modules.
- "High temperature" Ni-Cd / Ni-MH batteries.
- Charge indicator with LED.
- "Rest mode" facility with remote control device.

Dati tecnici / *Technical data*

- Lunghezza cavo batteria: 280 mm / 11".
- Lunghezza cavo LED: 350 mm / 13,8".
- Foro di montaggio LED: Ø 9 mm / 0,35".
- Corrente di alimentazione: 20 mA max.
- Portata morsettiera: 1,5 mm 2 / AWG15.
- Distanza massima dall'alimentatore dalla lampada: 2 m / 6 ft.
- Length battery cable: 280 mm / 11".
- Length LED cable: 350 mm / 13,8".
- LED mounting hole: Ø 9 mm / 0,35".
- Supply current: 20 mA max.
- Terminal blocks max. connection size: 1,5 mm 2 / AWG15.
- Max distance between driver and lamp: 2 mt / 6 ft.

Schema di collegamento non permanente (solo emergenza)
Wiring diagram - Non-maintained (emergency only)

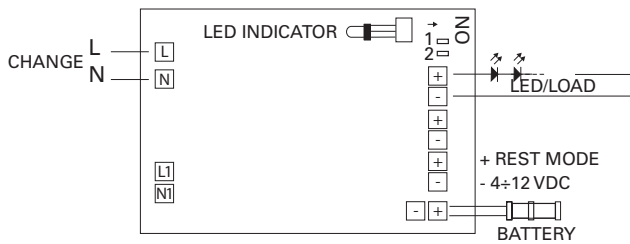

Schema di collegamento permanente (illuminazione ordinaria)
Wiring diagram - Maintained with external electronic driver

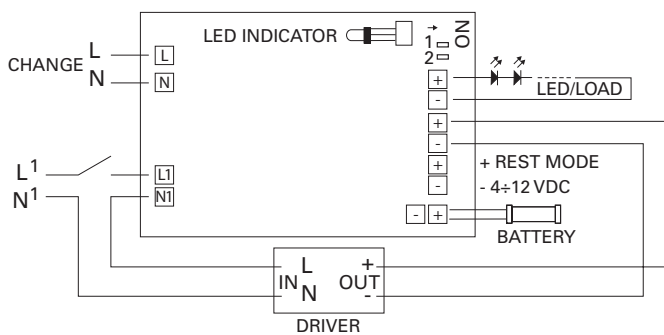

mA/Vf LED

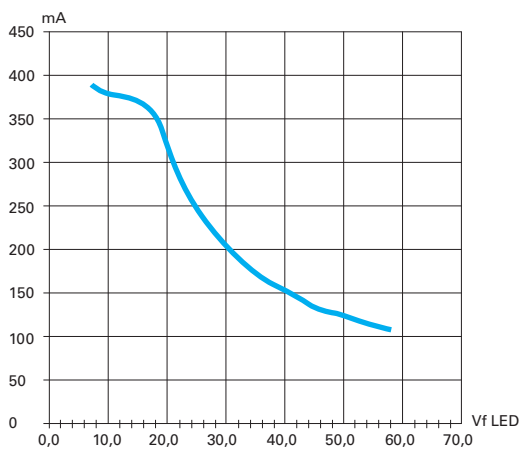

DIP-SWITCH	Working voltage during emergency (VL) Tensione di lavoro in emergenza (VL)	Output current during emergency (I) Corrente in uscita in emergenza (I)	n° LED max.	Power max. for LED modules Potenza max. per moduli LED
A	9...12 V	350 ± 10%	3/4	24V
B	9...24 V	350...250mA	7/8	30V
C	9...46 V	350...125mA	12/14	-
D	9...58 V	350...100mA	17/18	-

Light Sources

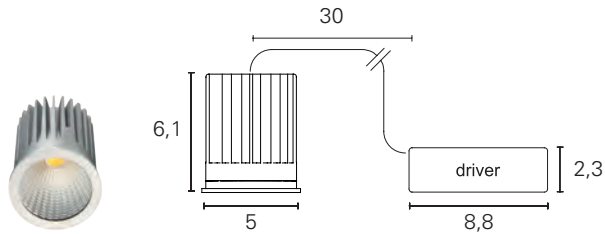

Versione Model	Codice Code	Alimentazione Power feeding	Potenza / Flusso Effettivo Power / Lumen Output	CCT CCT	Ottica Beam angle	Dimmerabile Dimmable	Durata Lifetime
Kit LED + Driver	LED8012	220÷240 V	9 W - 815 lm	3000 K	40 °	no	L80 / B20 – 50.000 h

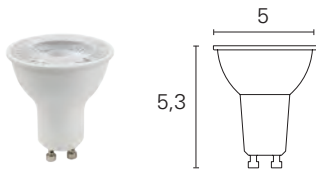

Versione Model	Codice Code	Alimentazione Power feeding	Attacco Socket	Potenza / Flusso Effettivo Power / Lumen Output	CCT CCT	Ottica Beam angle	Dimmerabile Dimmable	Classe energetica Energy Label	Durata Lifetime
GU10 LED	LED2072	AC175-250 V	GU10	7 W - 450 lm	3000 K	38 °	no	A+	15000 h



Versione Model	Codice Code	Alimentazione Power feeding	Attacco Socket	Potenza / Flusso Effettivo Power / Lumen Output	CCT CCT	Ottica Beam angle	Dimmerabile Dimmable	Classe energetica Energy Label	Durata Lifetime
GU5,3 LED	LED1072	12 V	GU5,3	7 W - 450 lm	3000 K	38 °	si	A+	15000 h

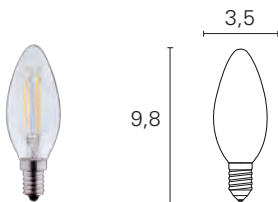

Versione Model	Codice Code	Alimentazione Power feeding	Attacco Socket	Potenza / Flusso Effettivo Power / Lumen Output	CCT CCT	Ottica Beam angle	Dimmerabile Dimmable	Classe energetica Energy Label	Durata Lifetime
Filament bulb LED	LED10010	220÷240 V	E14	4,8 W - 450 lm	2700 K	360 °	no	A++	15000 h



INFO

Optical system_p.526

Colour rendering_p.538

Wiring diagrams_p.542

13

OPTICAL SYSTEMS

Dark light

Un buon comfort visivo è elemento di primaria importanza nella progettazione illuminotecnica. Dalla scelta corretta dell'apparecchio e dalla sua installazione deriva benessere e salute dell'utilizzatore. Attenzioni speciali vengono richieste nell'ambiente di lavoro. La normativa prevede limitazioni dell'abbagliamento in presenza di video terminali ed occupazione protratta nel tempo (UNI EN 1837, UNI EN 12464-1 e UNI EN 11665) . Il controllo dell'indice di abbagliamento, dall'acronimo UGR (Unified Glare Rating) è l'elemento primario su cui porre le dovute attenzioni per evitare abbagliamenti eccessivi. La norma prevede che il luogo di lavoro debba disporre di adeguata illuminazione naturale e che la luce artificiale abbia intensità e qualità adatta a garantire il dovuto benessere. È di uso comune la scala UGR (valori da 10 a 30) che determina l'incidenza dell'abbagliamento nel campo visivo dell'utilizzatore. Abbagliamento considerevole per valori alti, abbagliamento scarso-assente per valori bassi (<19). Risulta evidente che un apparecchio appositamente progettato per garantire qualità e quantità dell'emissione risulti, assieme alla corretta progettazione degli ambienti, un punto fondamentale per massimizzare i benefici di ogni installazione.

Good visual comfort is a primary element in lighting design. Product correct choice and installation can grant well-being and health for users. Special attentions are required in the workplaces. The actual rules provides glare limitations in video terminals areas and over time occupancy. (UNI EN 1837, UNI EN 12464-1 e UNI EN 11665) The glare index control, acronym UGR (Unified Glare Rating) is the primary element to pay attention to avoid excessive glare. To respect standard rules workplaces must have adequate natural lighting and artificial light (intensity and quality) have to guarantee the necessary well-being .The UGR scale (values from 10 to 30) is commonly used and indicate the incidence of glare in the user's field vision. Considerable glare for high values, poor glare-absent for low values (<19). Device designed have to guarantee quality and quantity of flux. To maximize benefits of installation correct design of the environments is a key point too.

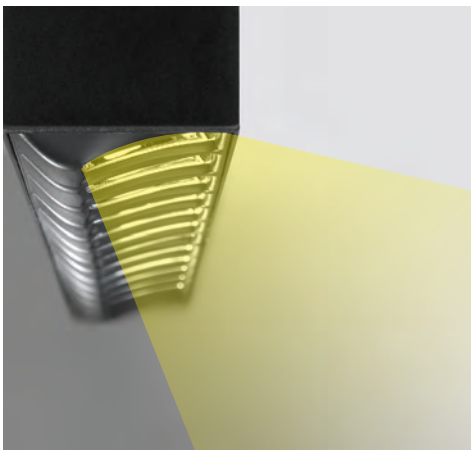

L'apparecchio viene posizionato con un rapporto di 3:1 tra altezza e distanza dalla parete.

The ceiling lamp is installed with a 3:1 ratio of height to distance to the wall.

Dark Performance

Asymmetric beam for wall-washing



Optic: Dark Grid Asymmetric
 Product Length: 1700 mm
 LED: 3000 K
 Power (Directlight): 36 W
 Surface area 1,8 m x 1 m
 Average illuminance >900 lx
 Uniformity 0,5

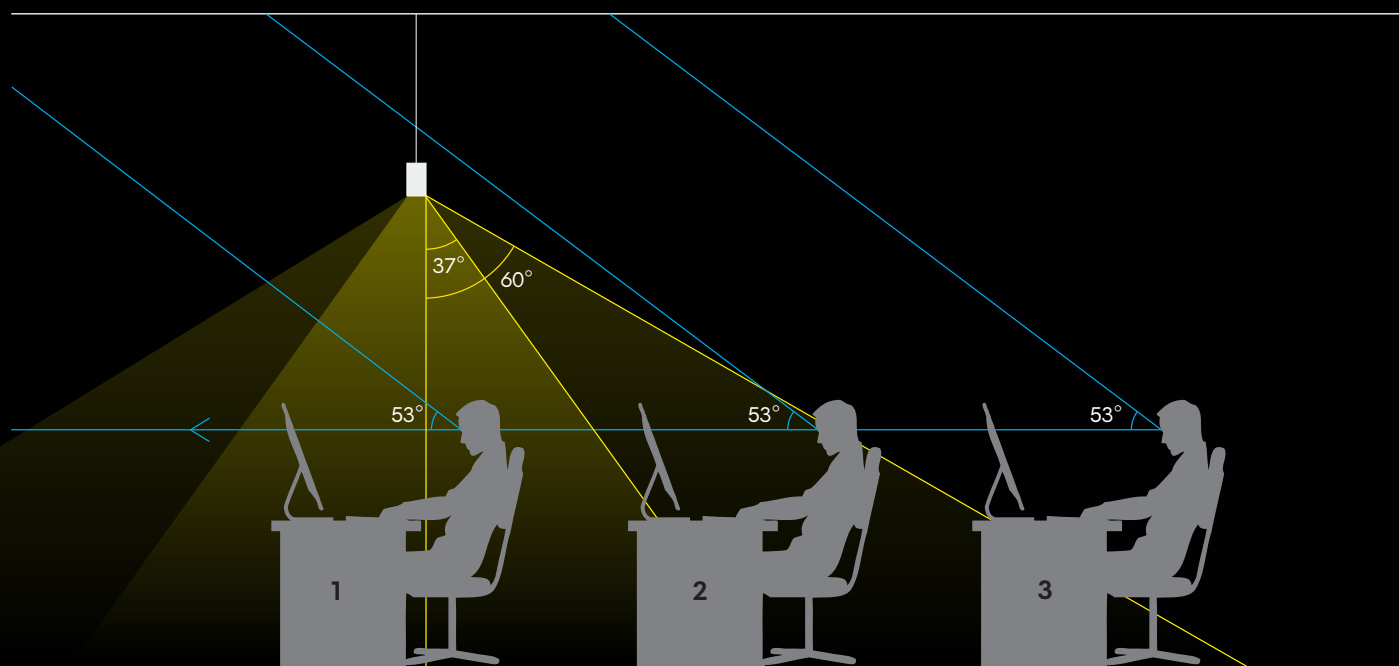

Il diagramma schematizza abbagliamento e campo visivo. Si assume che l'occhio dell'osservatore abbia una visione periferica orizzontale di circa 90 gradi. La visione periferica verticale è invece inferiore a 60 gradi.

The diagram offer a clear idea of glare and field of view. Observer's eye has a horizontal peripheral vision of about 90 degrees. Vertical peripheral vision, on the other hand, is less than 60 degrees

1

L'osservatore è in posizione ideale.
 L'apparecchio e la sorgente luminosa sono fuori dal campo visivo. L'abbagliamento non è un problema.

Observer ideal position: device and light source are out of sight. Glare is not a problem.

2

In questa posizione l'apparecchio è nel campo visivo. La presenza del flusso luminoso è lieve e non crea disagio.

Device position in the field of view. Presence of the luminous flux is slight and does not create discomfort.

3

L'osservatore è in questo caso fuori dal fascio di luce emesso dall'apparecchio, in zona di oscurità.

The observer is out of beam angle of light, in the dark area.

OPTICAL SYSTEMS

Karma

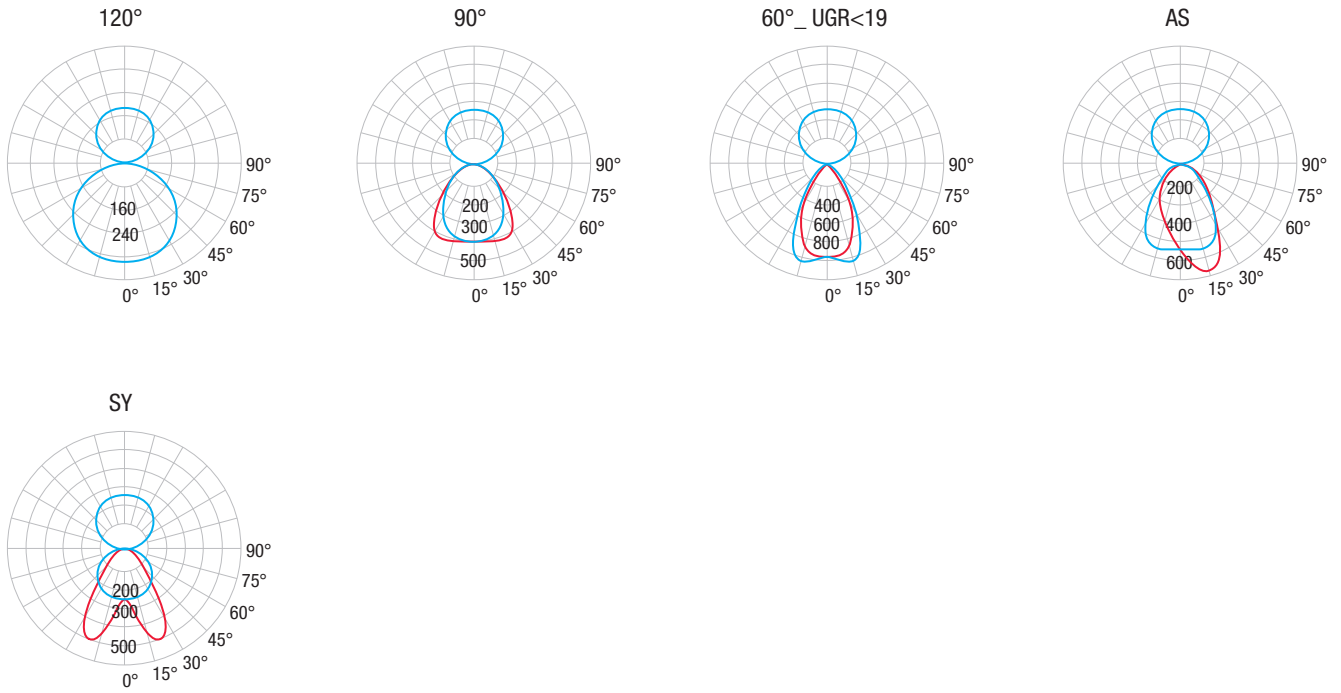

Maya / Maya_Mini

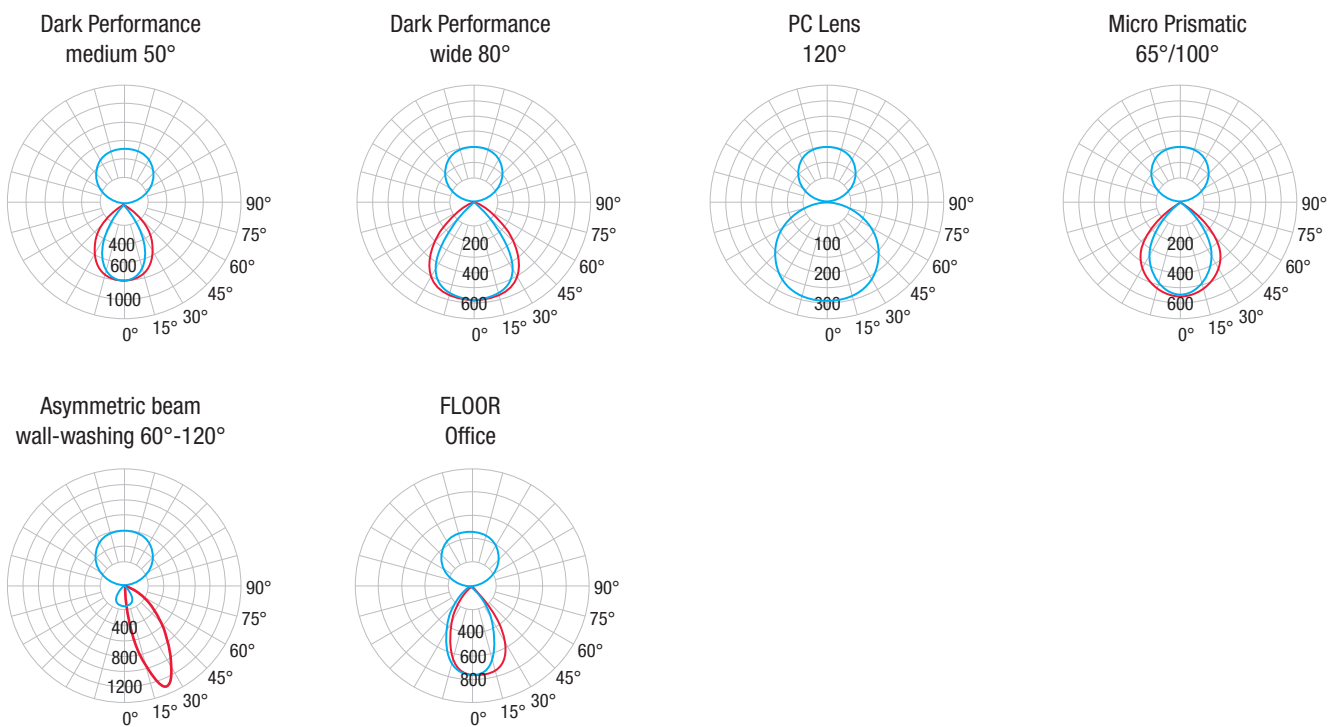

— C0-C180
— C90-C270

Nemo

Ring

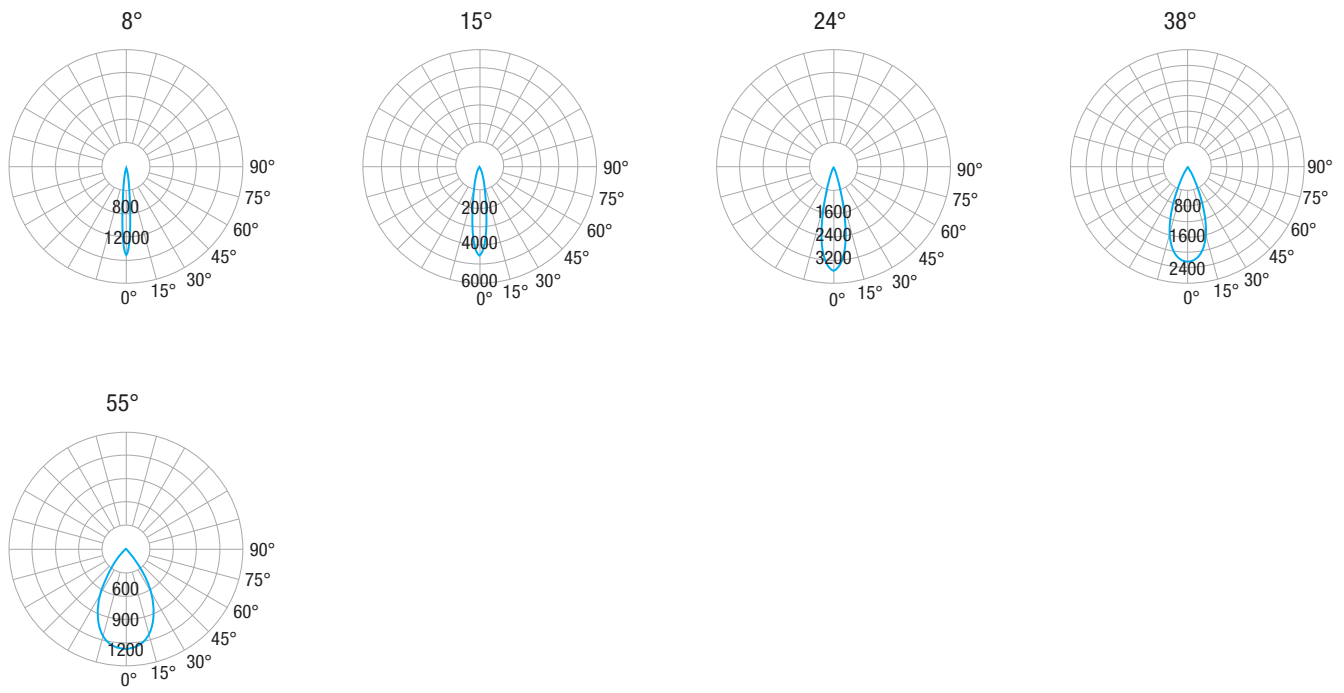

IP54

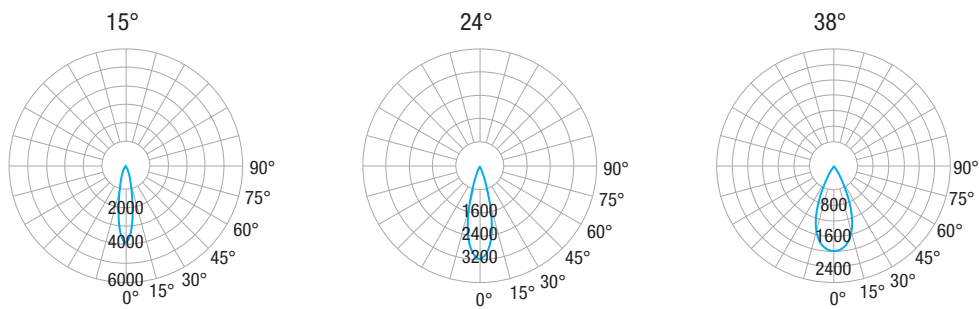

Simple

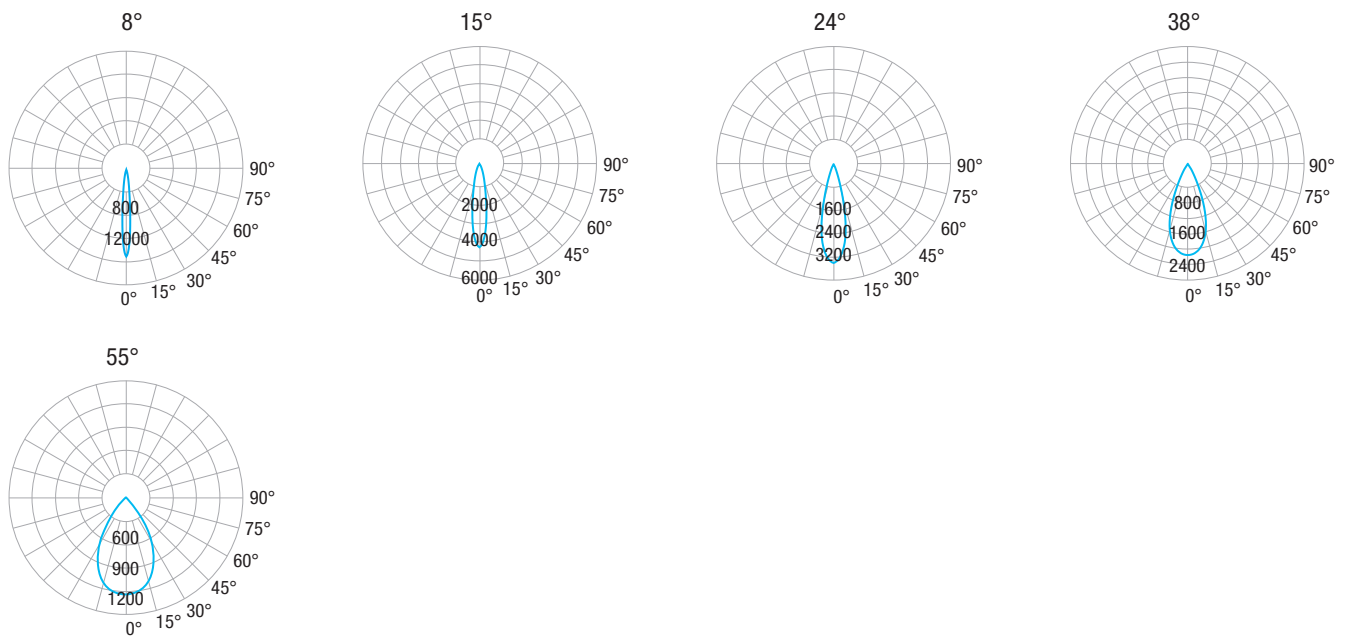

Nemo

Simple Asy

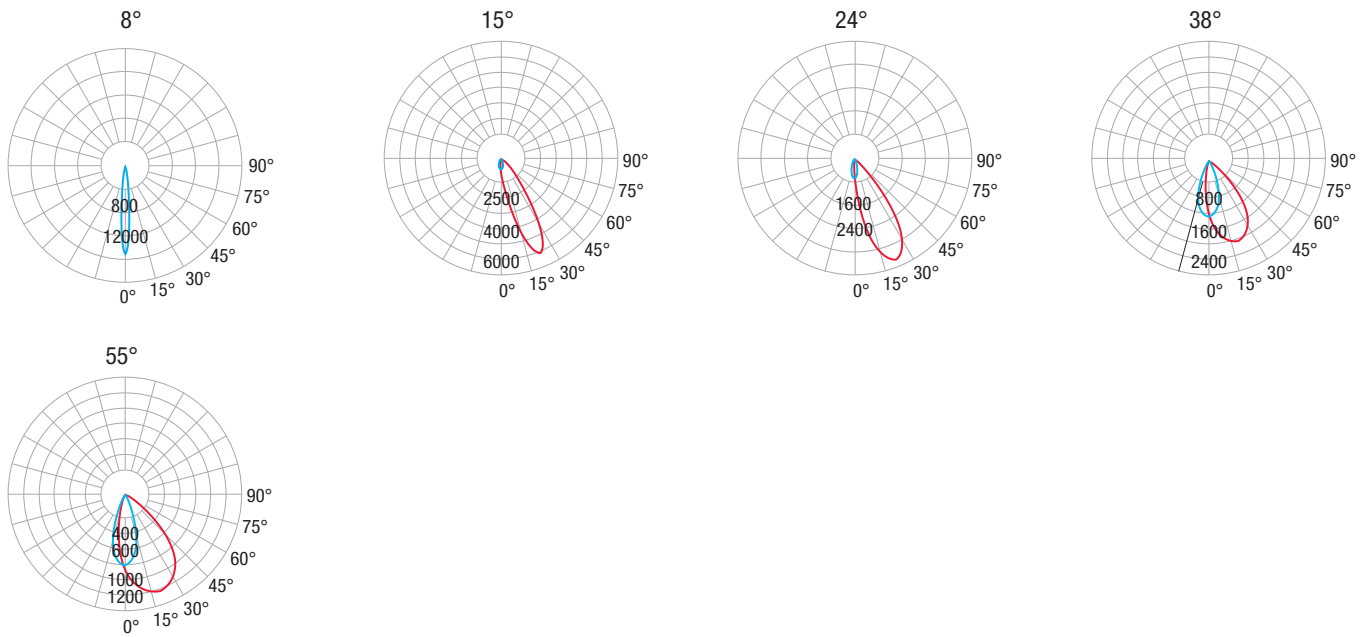

EYE

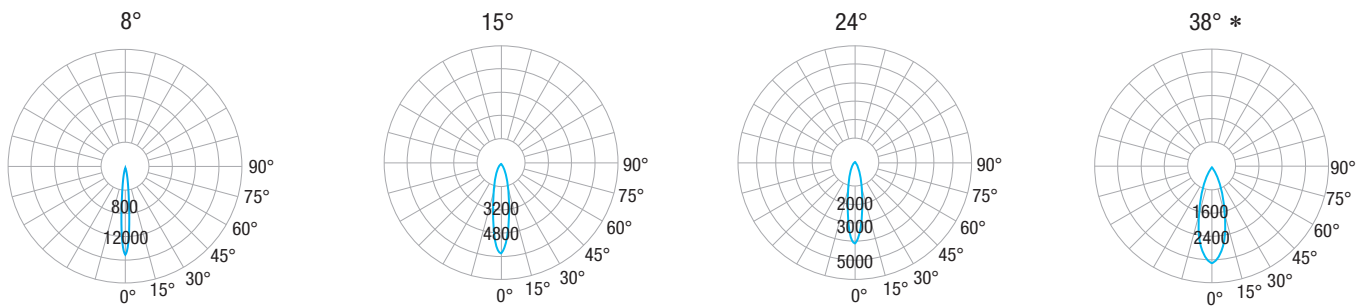

* Il frontale riduce a 32° il cono di luce in uscita. / The front ring reduces the cone of light out to 32°.

Beam

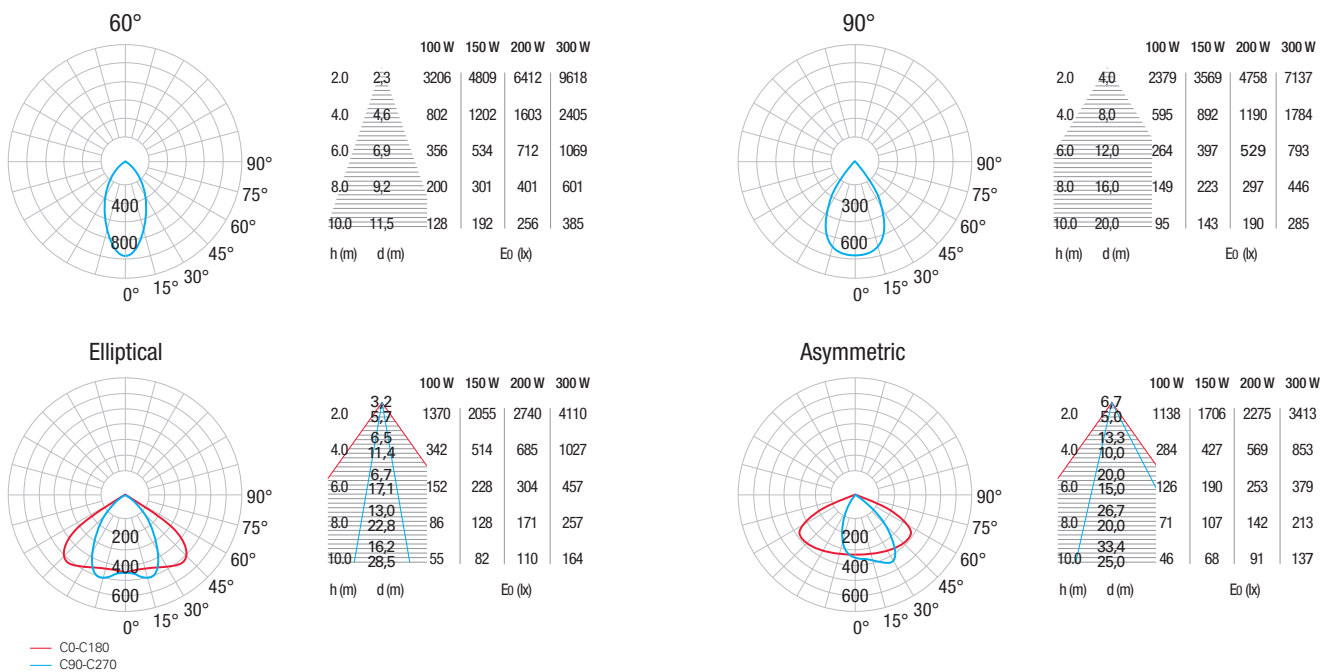

— CO-C180
— C90-C270

Puck_Extra

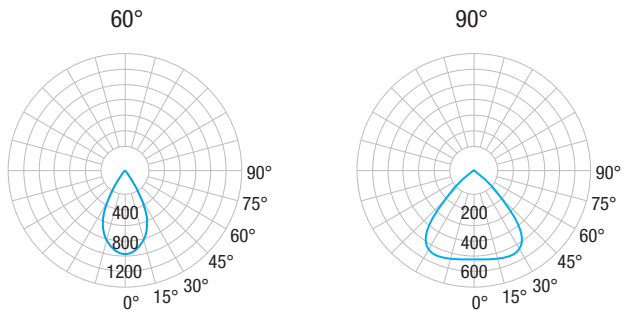

Bobby

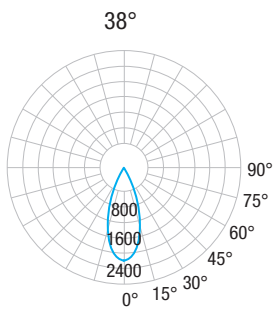

Jango

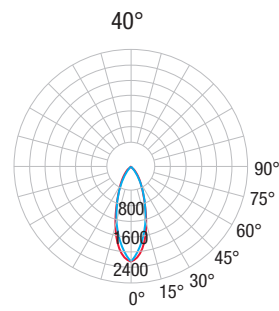

Show

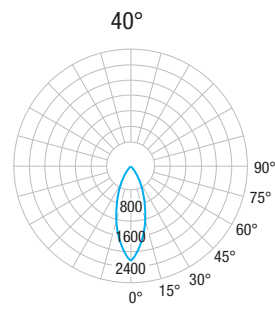

Focus

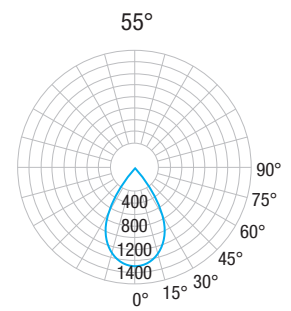
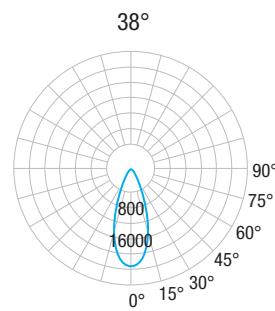
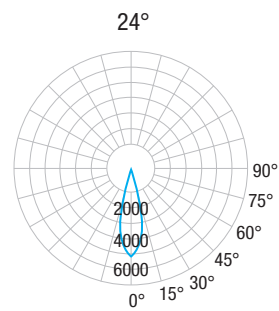
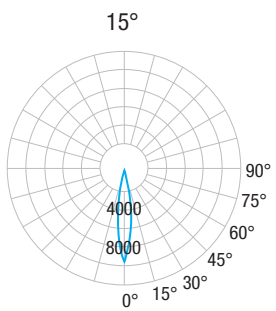

Pill

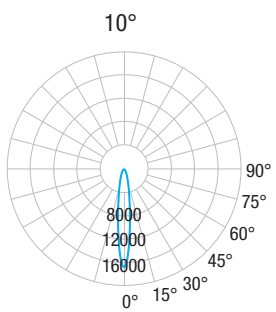

h (m)	d (m)	E ₀ (lx/klm)
1	0,17	17376
1.5	0,26	7723
2	0,34	4344
2.5	0,43	2780
3	0,51	1930

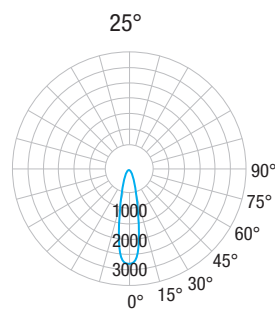

h (m)	d (m)	E ₀ (lx/klm)
1	0,41	2865
1.5	0,62	1273
2	0,83	716
2.5	1,04	458
3	1,24	318

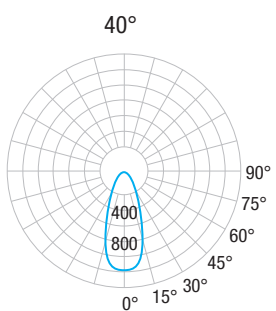

h (m)	d (m)	E ₀ (lx/klm)
1	0,7	1188
1.5	1	528
2	1,4	297
2.5	1,7	190
3	2,1	132

Quik

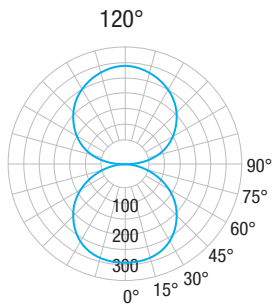

Egon

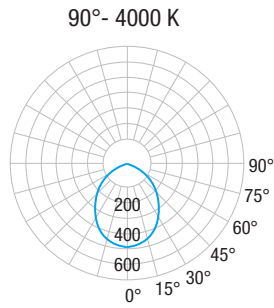

Microled

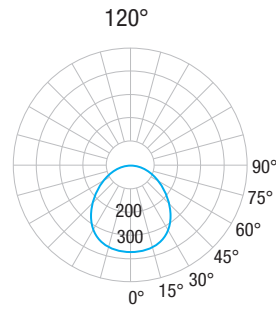

h (m)	d (m)	E0 (lx/klm)
1	2,7	371
1.5	4,1	165
2	5,4	93
2.5	6,8	59
3	8,1	41

Miniled

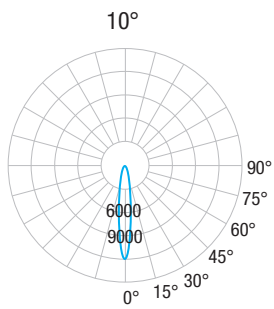

h (m)	d (m)	E0 (lx/klm)
1	0,18	12331
1.5	0,27	5480
2	0,36	3083
2.5	0,45	1973
3	0,54	1370

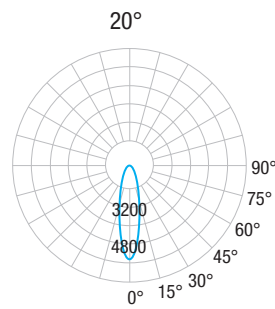

h (m)	d (m)	E0 (lx/klm)
1	0,31	6036
1.5	0,46	2683
2	0,61	1509
2.5	0,77	966
3	0,92	671

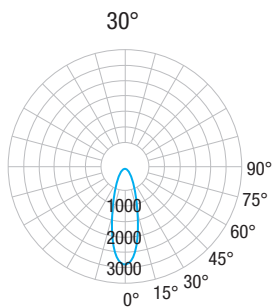

h (m)	d (m)	E0 (lx/klm)
1	0,5	2923
1.5	0,75	1299
2	1	731
2.5	1,3	468
3	1,5	325

Backlit

60x60 120°- 4000 K

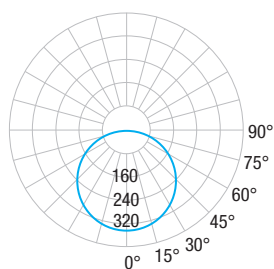

h (m)	d (m)	E0 (lx)
1	3	1251
1.5	4,5	556
2	6	313
2.5	7,5	200
3	9	139

UGR<19_60x60 90°- 4000 K

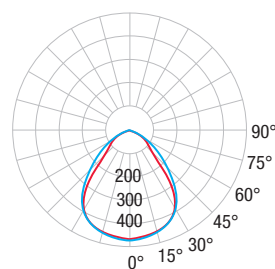

h (m)	d (m)	E0 (lx)
1	2	1666
1.5	2,9	741
2	3,9	417
2.5	4,9	267
3	5,9	185

UGR<19_30x120 90°- 4000 K

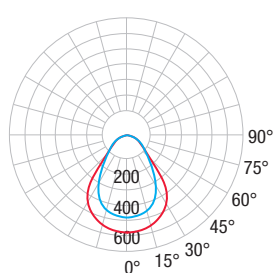

h (m)	d (m)	E0 (lx)
1	1,6	1930
1.5	2,4	858
2	3,1	483
2.5	3,9	309
3	4,7	214

UGR<19_60x120 90°- 4000 K

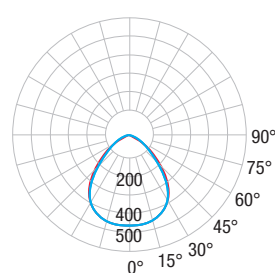

h (m)	d (m)	E0 (lx)
1	1,9	2556
1.5	2,8	1136
2	3,7	639
2.5	4,7	409
3	5,6	284

Led panel

UGR<19_60x60 120°- 4000 K

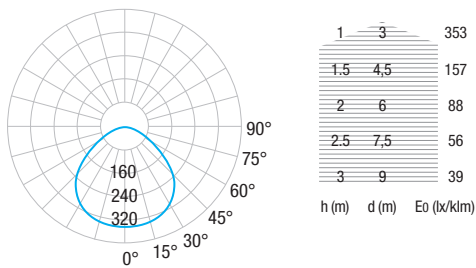

Microprismatic UGR<17_60x60 75°- 4000 K

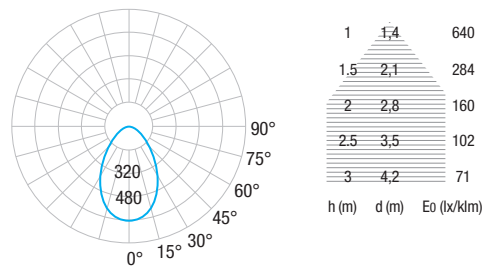

IP65_60x60 120°- 4000 K

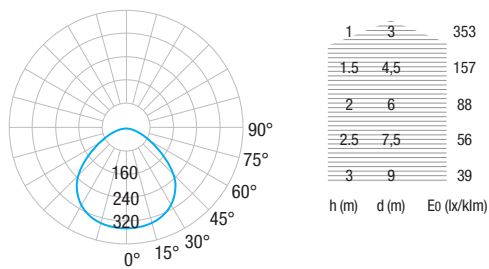

Tunable_60x60 120°- 4000 K

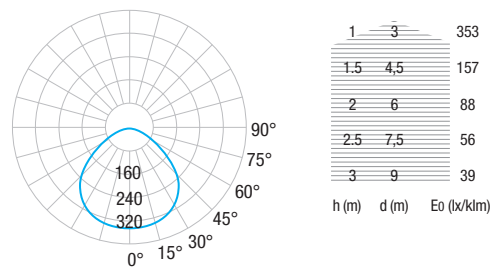

Moby

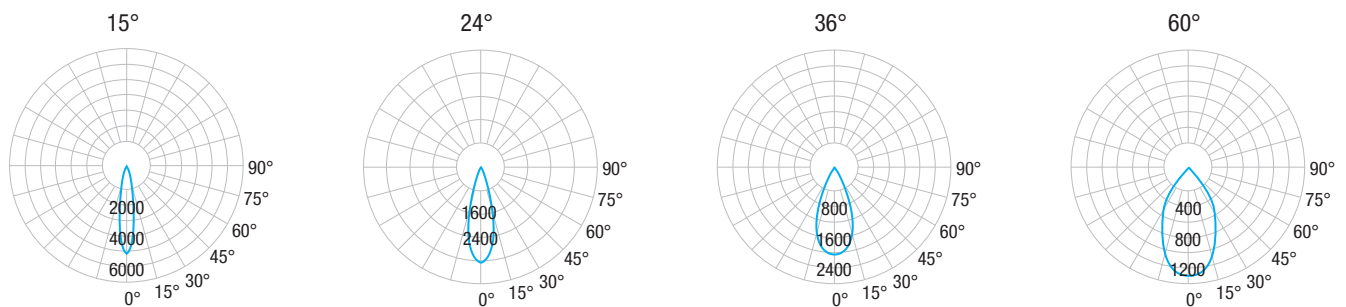

Ska

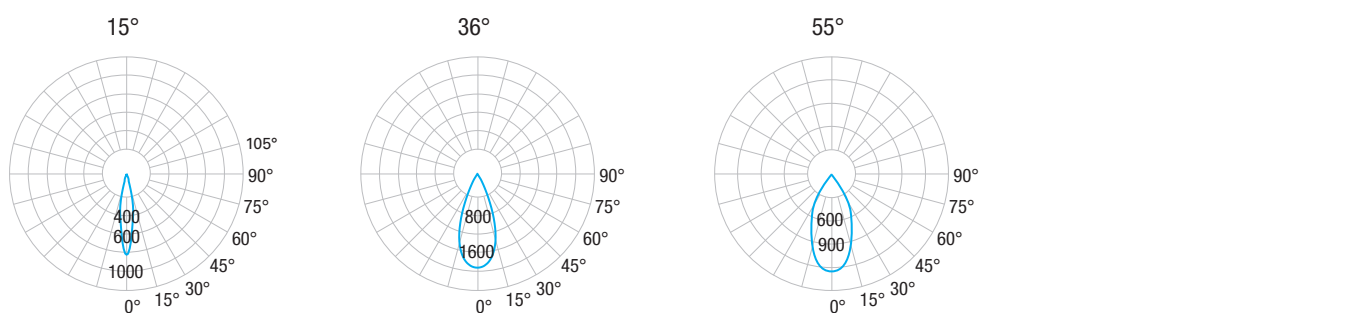

Slim

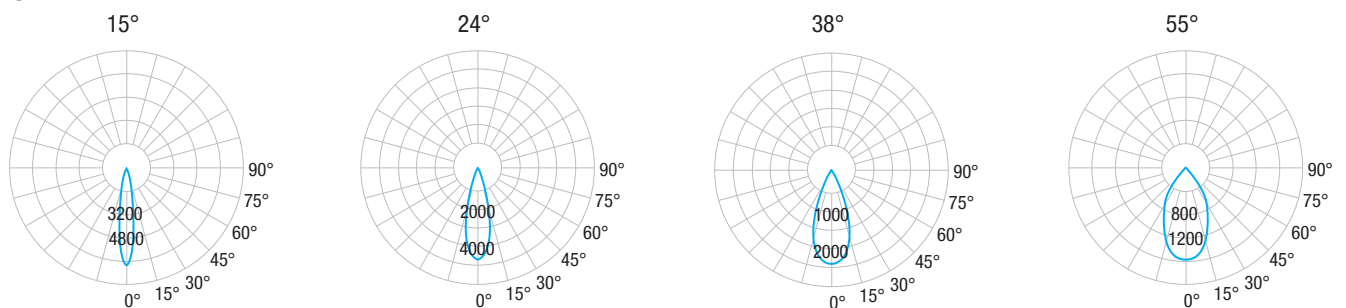

Sinergy

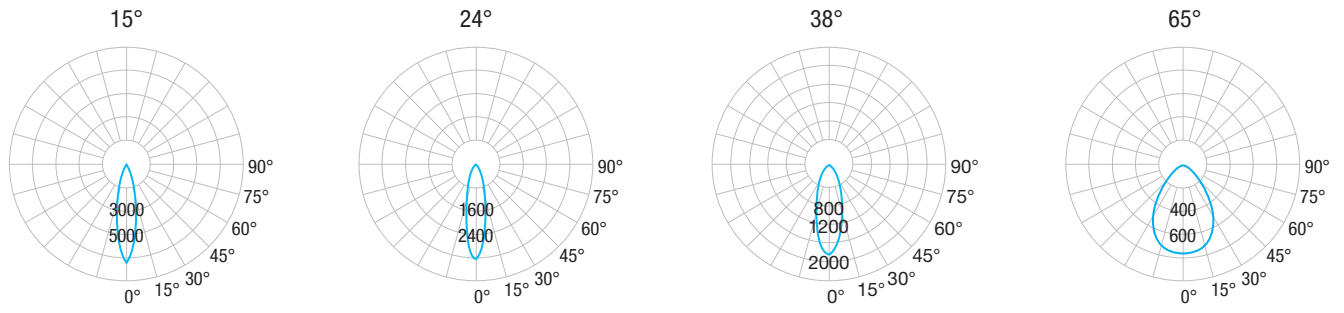

Extreme

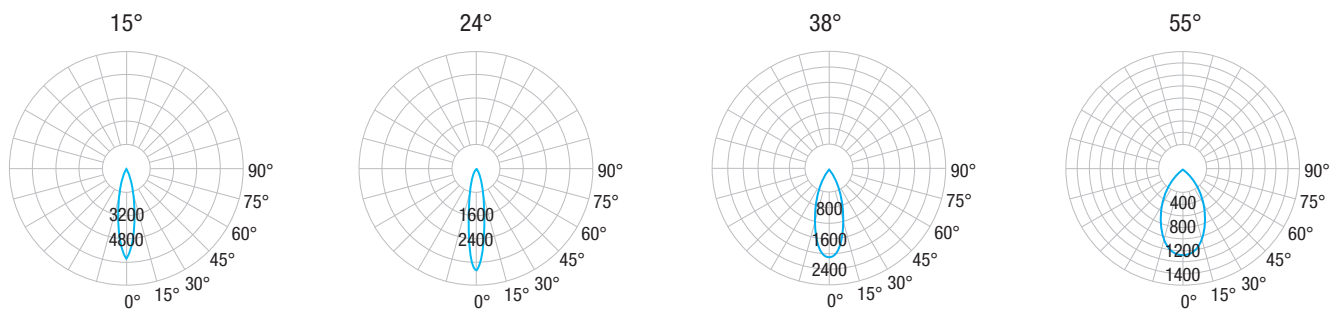

Day

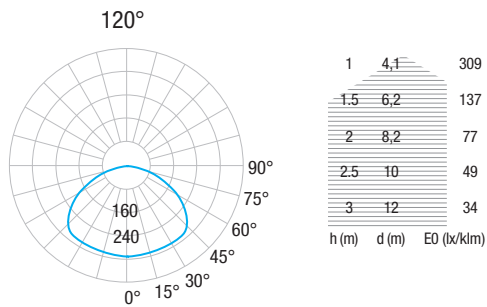

Hoop_Ceiling

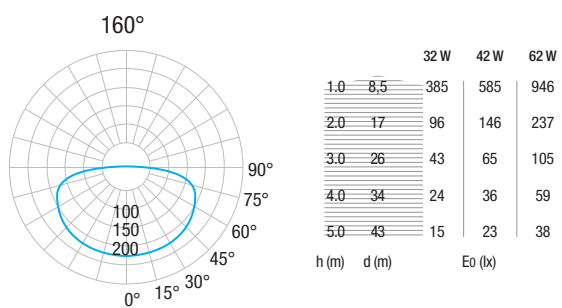

Corona_Ceiling

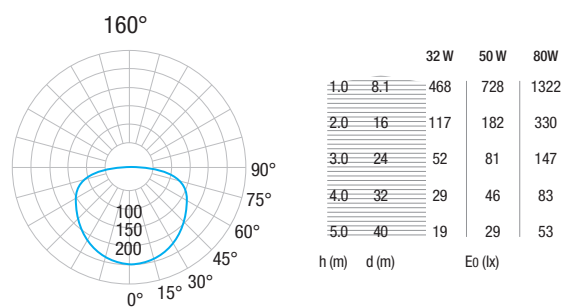

Kart_Ceiling

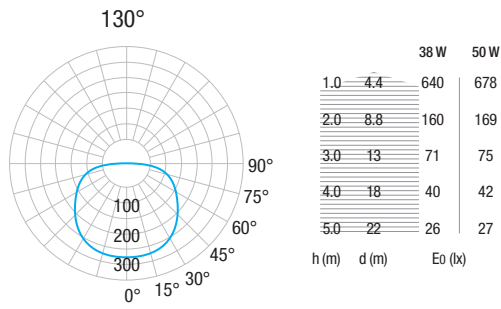

Bike_Ceiling

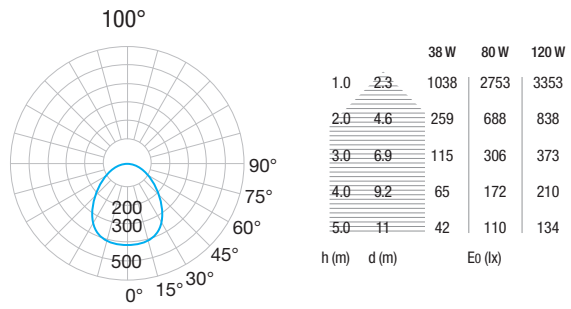

Young_Ceiling

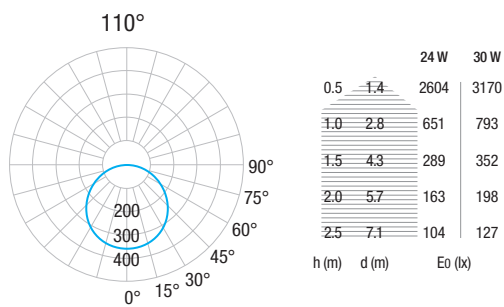

Play

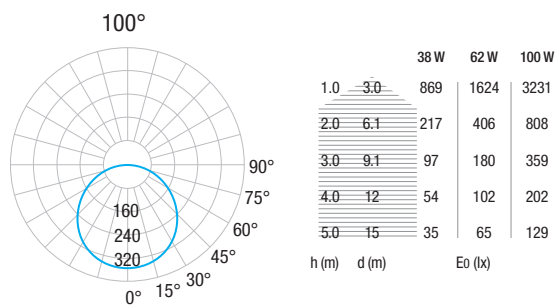

Dama_Ceiling

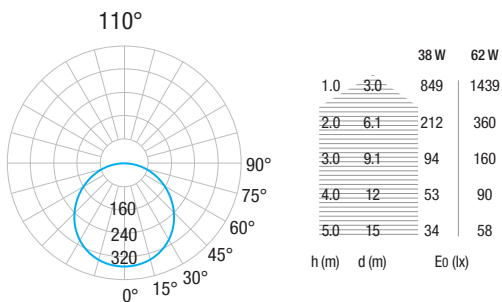

Bahia

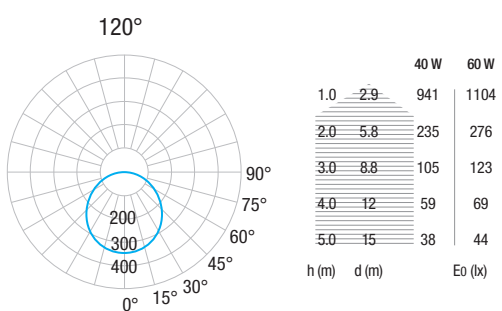

Hoop_Pendant

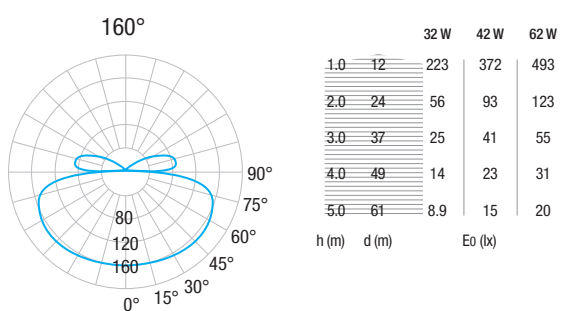

Corona_Pendant

160°

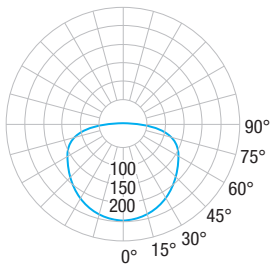

h (m)	d (m)	32 W	50 W	80 W
1.0	8.1	468	728	1322
2.0	16	117	182	330
3.0	24	52	81	147
4.0	32	29	46	83
5.0	40	19	29	53

Bike_Pendant

100°

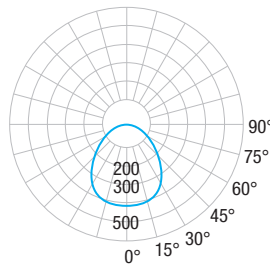

h (m)	d (m)	38 W	80 W	120 W
1.0	2.3	1038	2753	3353
2.0	4.6	259	688	838
3.0	6.9	115	306	373
4.0	9.2	65	172	210
5.0	11	42	110	134

Penny_Pendant

110°

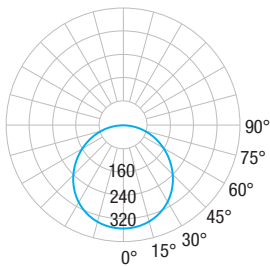

h (m)	d (m)	60 W	120 W	195 W
1.0	3.0	1349	3801	5542
2.0	6.0	337	950	1386
3.0	9.1	150	422	616
4.0	12	84	238	346
5.0	15	54	152	222

Kart_Pendant

130°

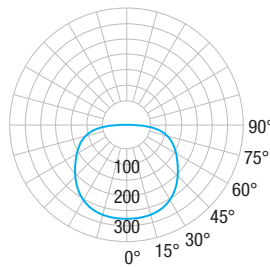

h (m)	d (m)	38 W	50 W
1.0	4.4	640	678
2.0	8.8	160	169
3.0	13	71	75
4.0	18	40	42
5.0	22	26	27

Lunar

110°

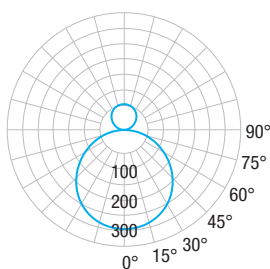

h (m)	d (m)	20 W
0.5	1.5	2278
1.0	2.9	569
1.5	4.4	253
2.0	5.8	142
2.5	7.3	91

Stek

30°

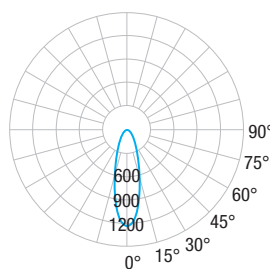

h (m)	d (m)	4,5 W
1.0	0.5	498
1.5	0.7	221
2.0	1.1	124
2.5	1.3	80
3.0	1.6	55

Cross

Ø 40 / 60 cm. - 100°

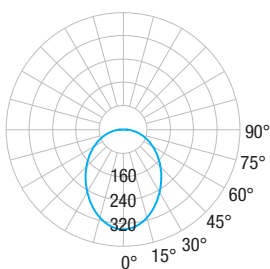

h (m)	d (m)	74 W
0.5	1.2	6742
1.0	2.5	1686
1.5	3.7	749
2.0	4.9	421
2.5	6.2	270

Ø 60 / 80 cm. - 100°

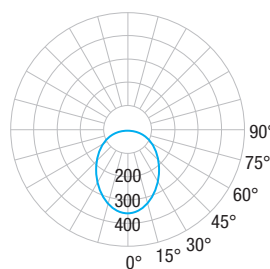

h (m)	d (m)	104 W
0.5	1.1	10867
1.0	2.1	2717
1.5	3.2	1207
2.0	4.2	679
2.5	5.3	435

Onda

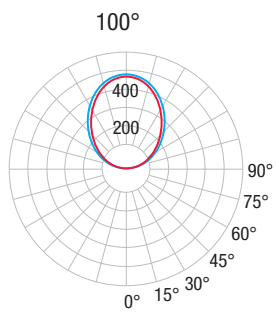

Elle

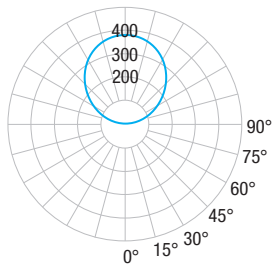

Polka

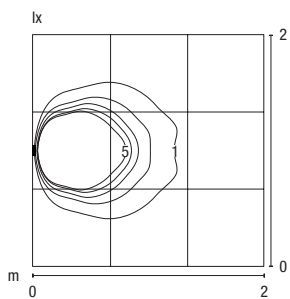
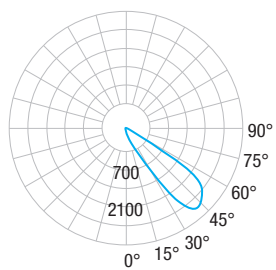

Fast

asimmetrico / asymmetric

diffusore / diffuser

3,6W - 45°

8,5W - 55°

3,6W - 150°

3,6W - 55°

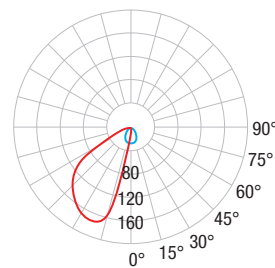
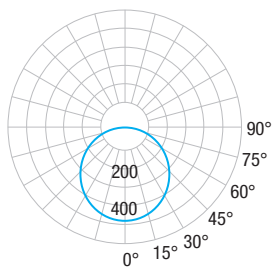
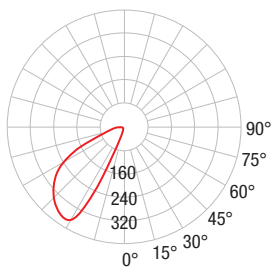
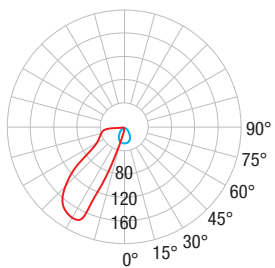

Dippy

7w

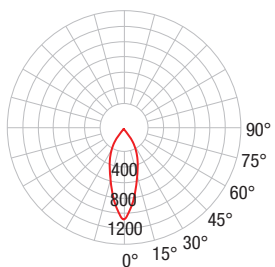

Pako

30°

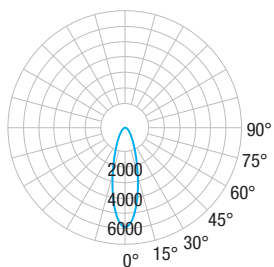

COLOUR RENDERING

KARMA

TM-30

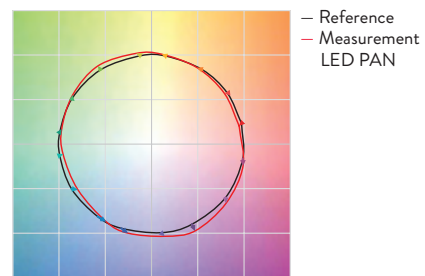
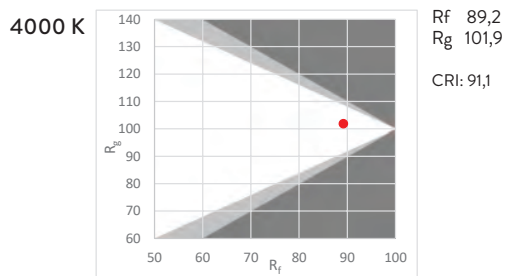
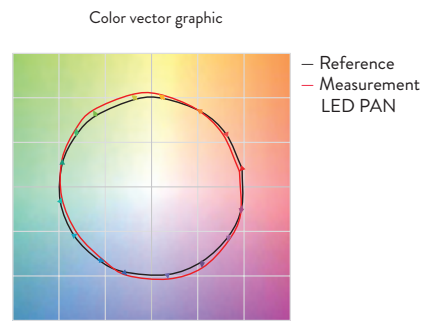
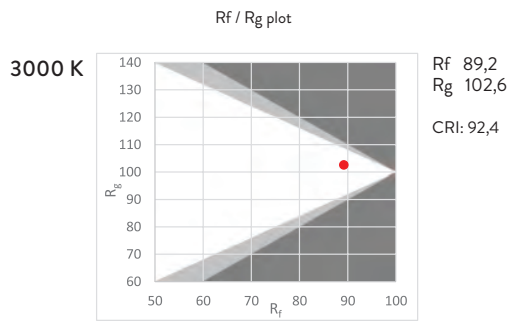

MAYA / MAYA_Mini

TM-30

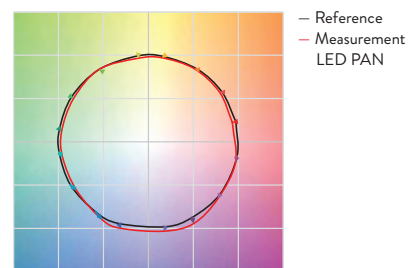
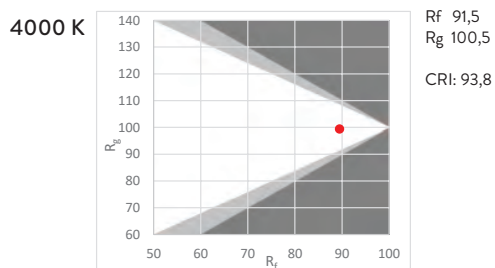
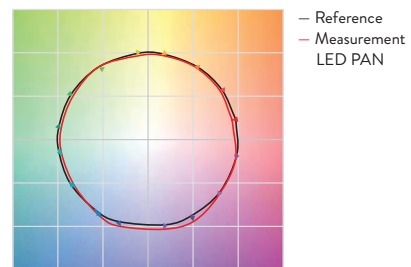
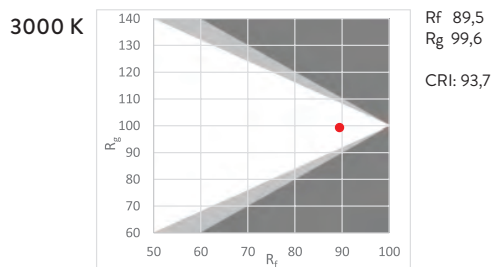
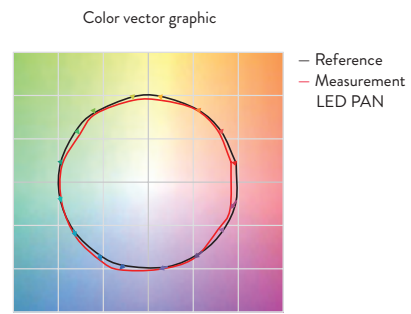
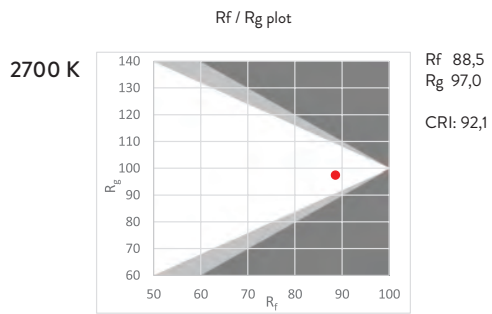

STRIPLED

TM-30

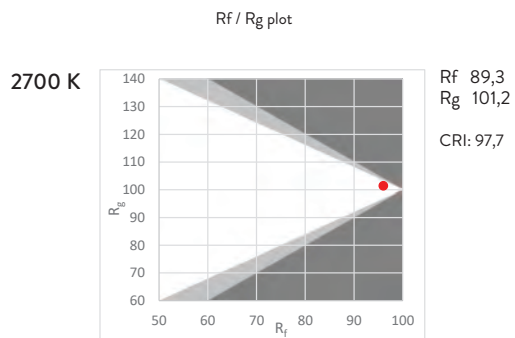

Color vector graphic

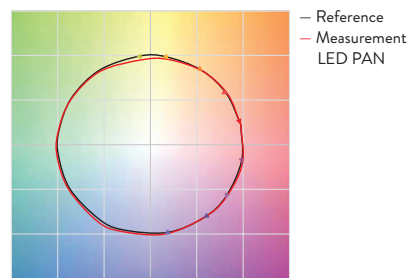
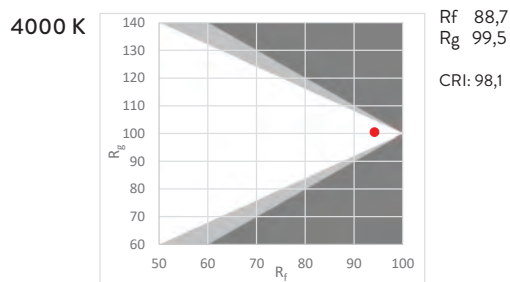
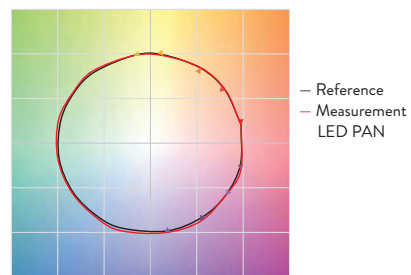
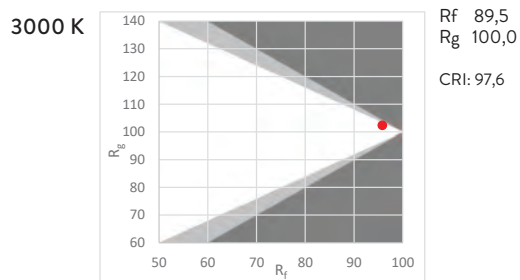
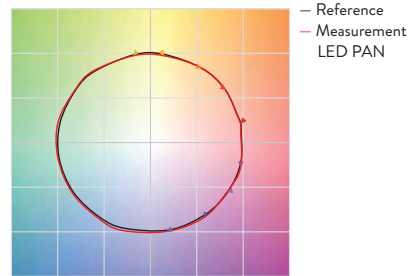

MOBY

TM-30

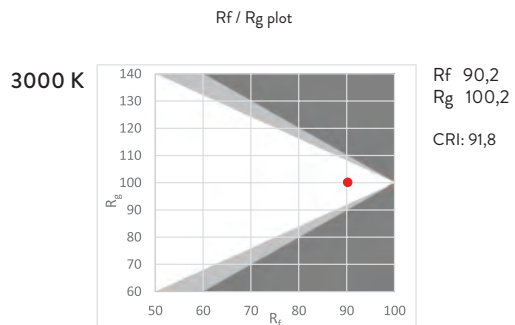

Color vector graphic

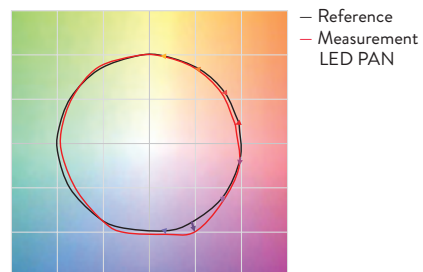
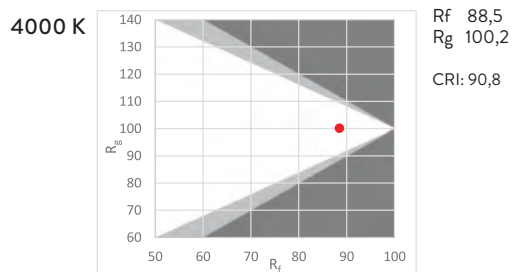
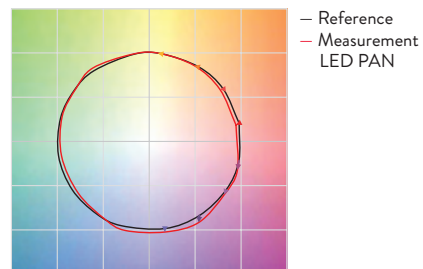

NEMO

TM-30

Rf / Rg plot

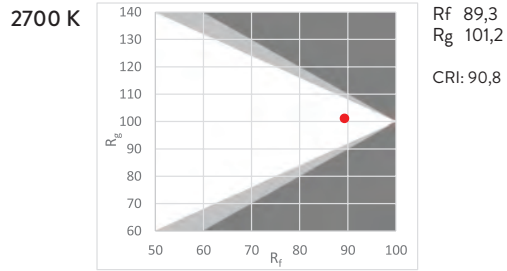

Color vector graphic

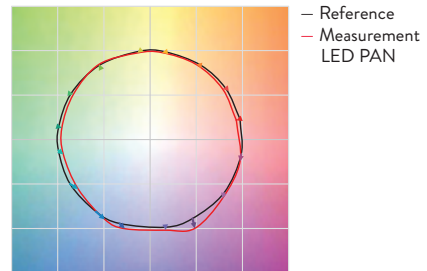
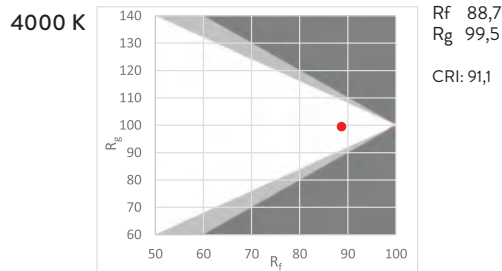
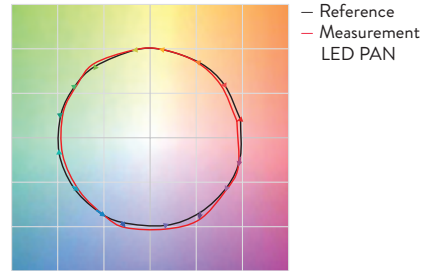
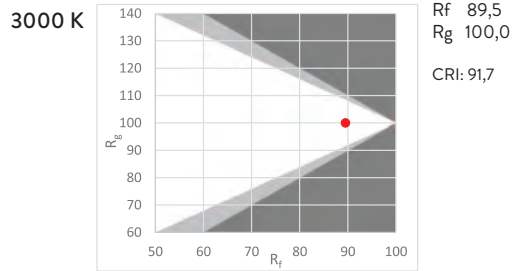
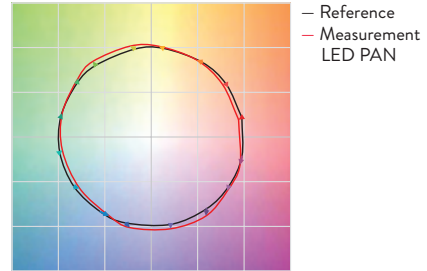

SLIM

TM-30

Rf / Rg plot

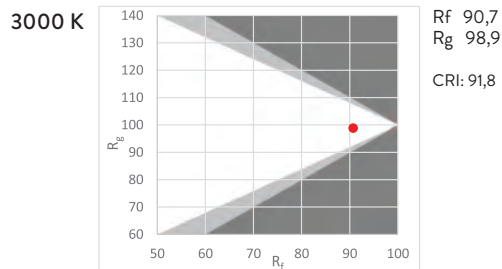

Color vector graphic

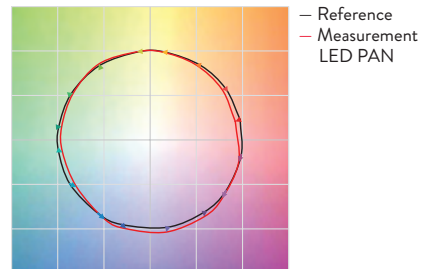
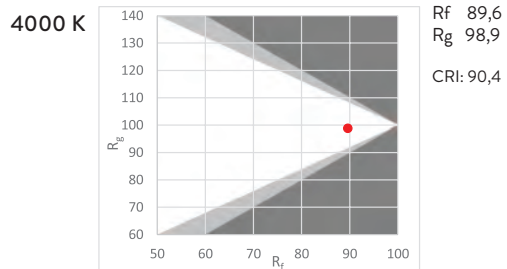
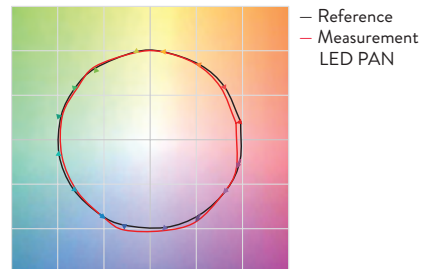

SKA

TM-30

Rf / Rg plot

3000 K

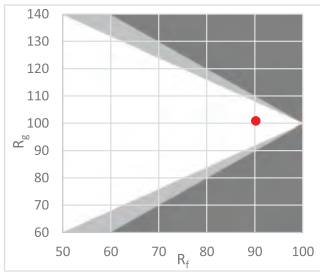

Rf 90,2
Rg 100,9
CRI: 92,3

Color vector graphic

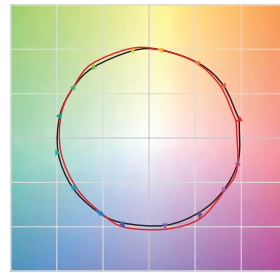

4000 K

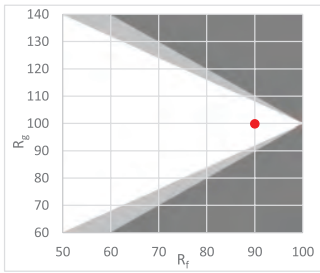

Rf 90,0
Rg 99,9
CRI: 92,7

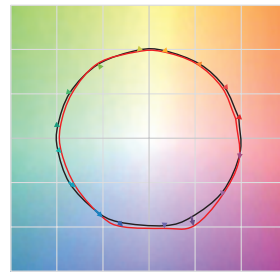



WIRING DIAGRAMS

Karma / Maya

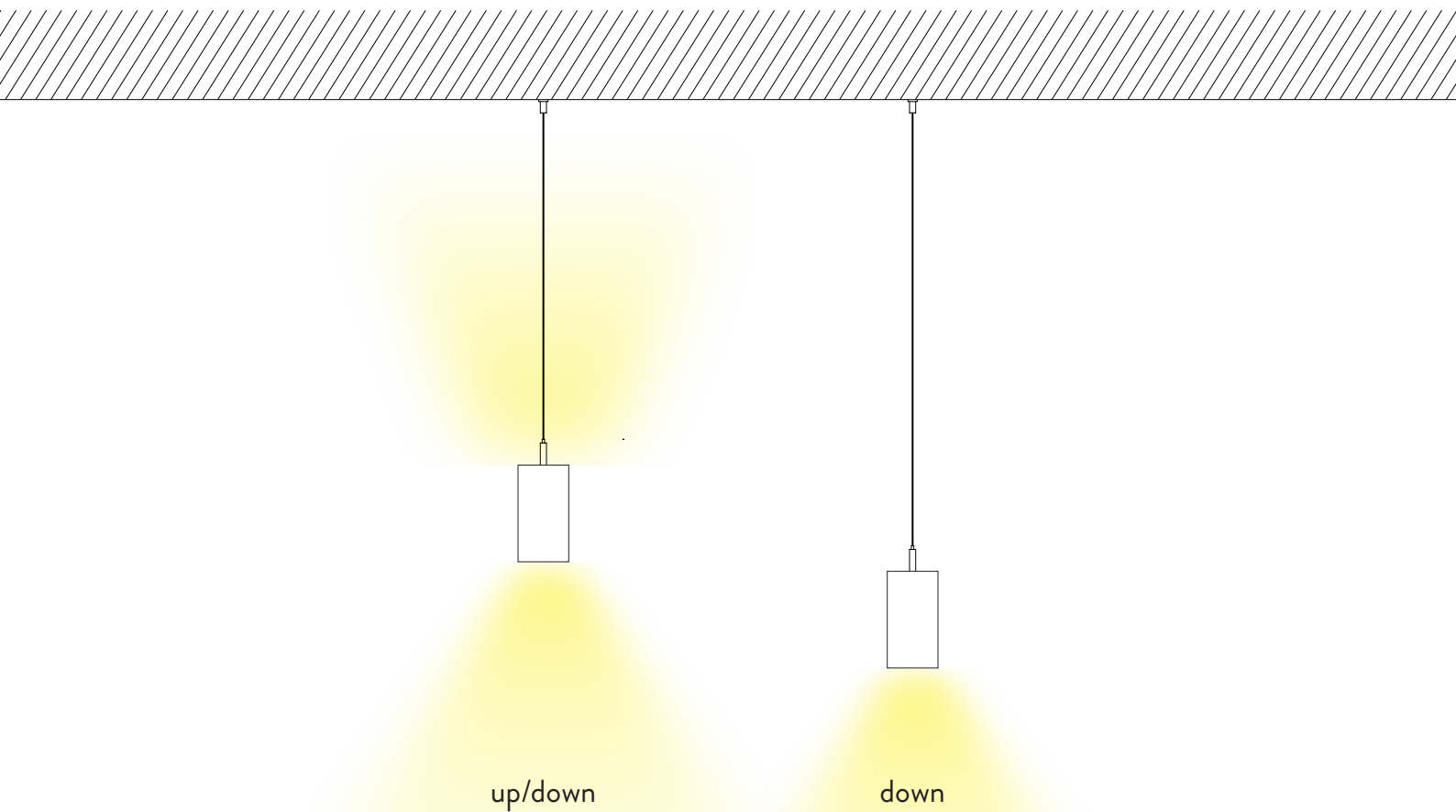
Pendant

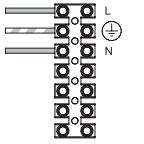
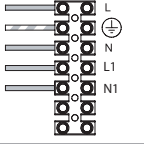
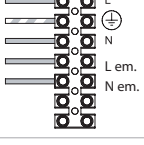
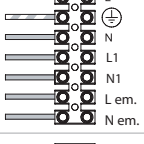
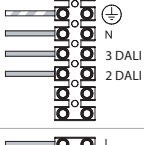
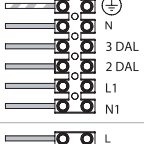
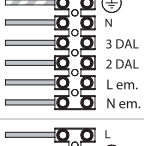
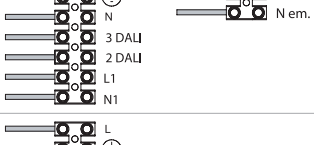
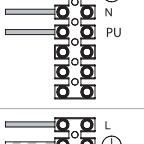
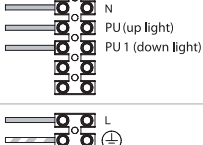
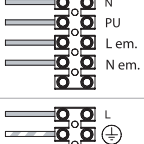
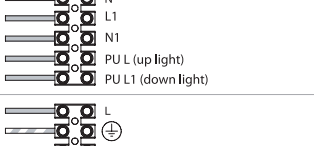

Schemi di cablaggio / Wiring diagrams

		<p>singolo rosone completo di cavo 3x 1,5 mm²</p>	<p>single canopy wired with 3x 1,5 mm² cable</p>
On / Off	<p>doppia accensione dual switch</p> 	<p>singolo rosone completo di cavo 5x 1,5 mm²</p>	<p>single canopy wired with 5x 1,5 mm² cable</p>
	<p>singola accensione + emergenza 1 h. single switch + emergency 1 h.</p> 	<p>singolo rosone completo di cavo 5x 1,5 mm²</p>	<p>single canopy wired with 5x 1,5 mm² cable</p>
	<p>doppia accensione + emergenza 1 h. dual switch + emergency 1 h.</p> 	<p>doppio rosone 1x completo di cavo 5x 1,5 mm² 1x completo di cavo 3x 1,5 mm²</p>	<p>dual canopies 1x wired with 5x 1,5 mm² cable 1x wired with 3x 1,5 mm² cable</p>
	<p>singola accensione single switch</p> 	<p>singolo rosone completo di cavo 5x 1,5 mm²</p>	<p>single canopy wired with 5x 1,5 mm² cable</p>
DALI	<p>doppia accensione dual switch</p> 	<p>doppio rosone 1x completo di cavo 5x 1,5 mm² 1x completo di cavo 3x 1,5 mm²</p>	<p>dual canopies 1x wired with 5x 1,5 mm² cable 1x wired with 3x 1,5 mm² cable</p>
	<p>singola accensione + emergenza 1 h. single switch + emergency 1 h.</p> 	<p>doppio rosone 1x completo di cavo 5x 1,5 mm² 1x completo di cavo 3x 1,5 mm²</p>	<p>dual canopies 1x wired with 5x 1,5 mm² cable 1x wired with 3x 1,5 mm² cable</p>
	<p>doppia accensione + emergenza 1 h. dual switch + emergency 1 h.</p> 	<p>doppio rosone 2x completi di cavo 5x 1,5 mm²</p>	<p>dual canopies both wired with 5x 1,5 mm² cable</p>
	<p>singola accensione single switch</p> 	<p>singolo rosone completo di cavo 5x 1,5 mm²</p>	<p>single canopy wired with 5x 1,5 mm² cable</p>
PUSH	<p>doppia accensione dual switch</p> 	<p>singolo rosone completo di cavo 5x 1,5 mm²</p>	<p>dual canopies both wired with 5x 1,5 mm² cable</p>
	<p>singola accensione + emergenza 1 h. single switch + emergency 1 h.</p> 	<p>doppio rosone 1x completo di cavo 5x 1,5 mm² 1x completo di cavo 3x 1,5 mm²</p>	<p>dual canopies 1x wired with 5x 1,5 mm² cable 1x wired with 3x 1,5 mm² cable</p>
	<p>doppia accensione + emergenza 1 h. dual switch + emergency 1 h.</p> 	<p>doppio rosone 1x completo di cavo 5x 1,5 mm² 1x completo di cavo 3x 1,5 mm²</p>	<p>dual canopies 1x wired with 5x 1,5 mm² cable 1x wired with 3x 1,5 mm² cable</p>
	<p>singola accensione o doppia accensione single switch or dual switch</p> 	<p>singolo rosone completo di cavo 3x 1,5 mm²</p>	<p>single canopy wired with 3x 1,5 mm² cable</p>
CASAMBI			

Concept and Design
Studio grafico PAN

Print
Grafiche Antiga



PAN Srl
Via G. Michelucci 1
50028 Barberino Tavarnelle
Firenze, Italy

Information
Tel. +39 055 8059336
Fax +39 055 8059338
panint@panint.it
export@panint.it
panint.it

© 2023-07

Member Of
archiproducts®



PANINT.IT